

ION GUDJU • GHEORGHE IACOBESCU • OVIDIU IONESCU

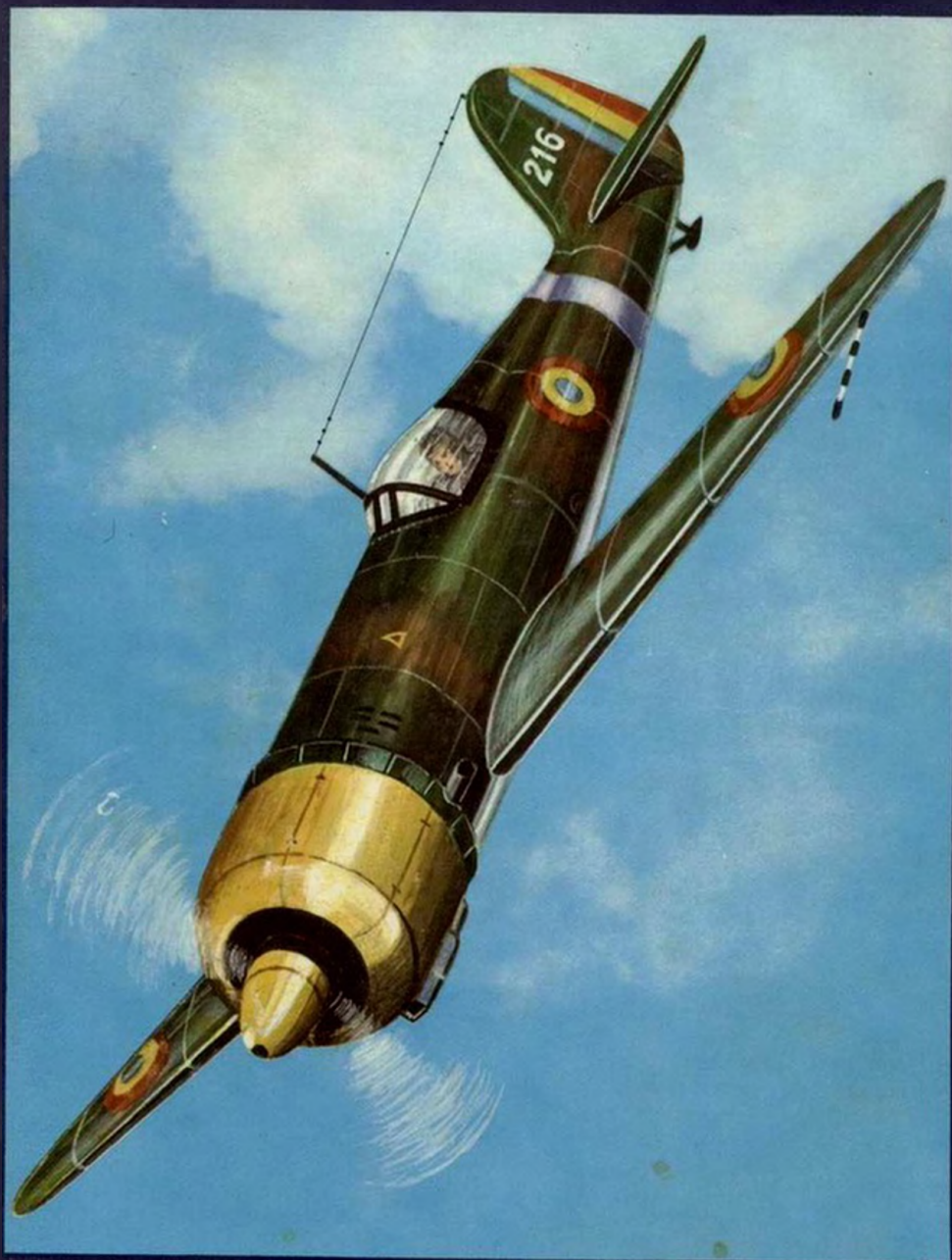

ROMANIAN AERONAUTICAL CONSTRUCTIONS  
1905—1974

## CONTENTS

<b>Preface to the English Edition</b> .....	7
<b>Foreword</b> .....	9
<b>A Short Historical Essay on the Evolution of Romanian Aeronautical Constructions</b>	
Romanian Aircraft Constructors During the Pioneer Days of Aviation .....	15
Private Venture Aircraft Constructions before and after the Emergence of the Romanian Aeronautical Industry .....	32
Romania's Aeronautical Industry, Beginnings and Development .....	37
— Aeroplanes .....	37
— Engines .....	48
— Aircraft Equipment and Apparatus .....	50
— Life-Saving Equipment .....	54
Aeronautical Laboratories .....	56
Flight Tests .....	61
<b>Romanian Aircraft Constructions</b> (Characteristics, Performances, Descriptions, Silhouettes)	
— Aeroplanes .....	67
— Helicopters .....	263
— Gliders .....	273
— Ground Effect—Air Cushion—Machines .....	351
<b>Technical Data Tables</b> .....	380



## PREFACE TO THE ENGLISH EDITION

*The initial edition of this volume was published in 1970 for the information of the Romanian public, and its success was instantaneous: within a few days the bookstores reported the termination of stocks. Shortly afterwards various points were raised in discussions on the book, especially by aircraft industry veterans, resulting in several interesting revisions and additions. Moreover, the new ground effect machines sector was found to have reached a sufficiently mature stage to deserve a presentation. In the meantime, suggestions came to print an English edition.*

*And so, a book has now been specially prepared to give the world topical and more or less systematic information on the past and present of Romanian aeronautics. "More or less," because it refers to information collected and grouped up to this date. But one must bear in mind that investigations into the past are actively continued, new features and facts being possibly and even probably discovered in future studies on the history of Romanian aeronautics.*

*As will be seen, this volume deals mainly with aircraft construction, a domain in which we Romanians can claim to be — chronologically — among the first in the world. Though scarcely known in other countries, our designers and our aeronautical industry have created a long and worthy tradition, combining advanced solutions with rather limited means of construction and yet achieving several aeroplanes of high standing. This may be the reason why, in spite of the no less meritorious feats in operation, the first subject choice fell on construction. Although technically accurate, this book does not pretend to be rigidly scientific. Above all, its aim is to present pertinent information, mostly historical, giving a clear indication of the background that supports our rejuvenated aeronautical*

*research, development and industry. Indeed, 73 original types and variants, totalling over two thousand Service and civil aircraft, are quite an achievement. The merits of the book's team of authors in highlighting this success are large and multifarious. Their work was not only scrupulous; it has been permanently permeated with love for their country's aviation.*

*Among them, the late Colonel Gheorghe Iacobescu was one of the best and most highly esteemed teachers Romanian aeronautics ever had, and he was well known in European aviation circles in the third and fourth decades of this century. He worked on this book up to the end of his life.*

*Having been one of his pupils over 30 years ago, I am proud to have the honour of preparing the present edition. And I sincerely hope that this book will be accepted as an "open house" of Romanian aeronautics.*

September, 1973.

MATEI I. OROVEANU

*Since time immemorial man aspired to leave the earth and jump into space. The desire to unlock the secrets of surrounding nature and to travel into the sky lent wings to the human mind, which in the course of centuries conceived the most fantastic means of flying.*

*Numerous fairy-tales, legends and stories from our own parts and from countries all over the world which we heard or read with great emotion in our childhood are dominated by brave heroes and Princes Charming who rose into the sky on winged horses to do battle with dragons and other monsters. Daedalus and Icarus in Greek mythology, Phaeton in the Metamorphoses of the great Roman poet Ovid, Rama in the Indian epos Ramayana, Kai-Kaus in the old Tadzhik story, Alexander the Great and the Romanian master-builder Manole are a few heroes of the fairy-tales, legends and stories pointing to the millenary desire of man to fly and also to the permanence of his dream.*

*It is quite obvious that many centuries ago the creative inventiveness of man could not conceive flying machines of the kind made in our own days. What it imagined were fantastic concoctions reflecting a primitive knowledge of the environment.*

*In the course of thousands of years man gradually wrested the secrets of flight from nature. The descendants of Icarus eventually transformed fantastic dreams into reality and succeeded in becoming the masters of the aerial ocean.*

*The fulfilment of the dream was achieved at the price of many sacrifices because man did not always set out to its achievement with the full panoply of knowledge that secures the victory in the long and difficult battle for the conquest of the sky. Nowadays it is fully acknowledged that the victory in the conquest of the air was*



obtained with the assistance of the aerodynes, the heavier-than-air machines capable of fully meeting the fundamental requirements of air navigation (speed, height and range) that secures the control of flying machines, their travel from one point to another according to the will of the pilot, in contrast to the aerostats, lighter-than-air ships which, although dominant in the period preceding the aeroplane, were at the mercy of air streams.

Aviation appeared in the first decade of the 20th century. In those years of the birth of world aviation, which coincided with the inception of Romanian aviation, the creative genius of our people also found courageous expression in mechanical flight, asserting itself internationally in the first place through its representatives Traian Vuia, Henri Coandă and Aurel Vlaicu, whose achievements helped the shape and development of world aviation. That is why the history of the conquest of the air has given them a well-deserved place in the ranks of the pioneers of aviation. The original ideas they applied in building aeroplanes, together with the efforts and achievements of other Romanian constructors of the same period, and afterwards in the Romanian aerospace industry that continued their endeavours, entitle us to say that Romania is one of the countries having a tradition in aircraft construction, a tradition that has been taken over and is carried forward in our own days.

This volume presents Romanian aircraft — aeroplanes, seaplanes, helicopters and gliders — built since the birth of aviation up to the present. Most of the reference material used by the authors has been obtained from the aircraft constructors themselves or from their co-workers, and some plans have been specially re-drawn on the basis of technical documentation and other data for this volume by the men who had conceived, designed or built the respective machines, or had participated in that work.

However, some of the planes built in the past are only mentioned, and in the case of others the description is incomplete; this is due either to the fact that the authors have not succeeded in finding sufficiently exact documentary material in the publications of the period, or to the absence of such reference material. The volume includes a brief history of the inception and development of the aeronautical industry in this country, and presents the principal achievements and some of the specific features of the Romanian school of aeronautical science and technique, and the rank attained by its value and prestige in the world.

We do not consider this to be an exhaustive study. There obviously still are facts in the rich past of Romanian aviation that have to be investigated and brought to light. The love of that wonderful past entails the patriotic duty of continuing such investigations and of adding new, so far unpublished pages to the history of our aviation.

*We take this opportunity to thank all those who enabled us to publish this volume, which we consider a homage to the passionate and patriotic men who dedicated their entire creative energy to the progress of Romanian aviation. This volume, ROMANIAN AERONAUTICAL CONSTRUCTIONS, fills a gap in specialized literature, and we believe it will help to give a better insight into the contribution of Romanian aircraft constructors and inventors, the more so as the ingenious and daring solutions put forward by some of them — H. Coandă, R. Goliescu, I. Stroescu, a.o.,—at the start of the assault for the conquest of the air, also had a decisive influence on the present development of aviation. This should be an incentive for the new achievements which our people expect from the young generations of Romanian aircraft designers and constructors.*

THE AUTHORS





A SHORT HISTORICAL ESSAY  
ON THE EVOLUTION  
OF ROMANIAN AERONAUTICAL  
CONSTRUCTIONS





## ROMANIAN AIRCRAFT CONSTRUCTORS DURING THE PIONEER DAYS OF AVIATION



The first attempts to fly, confirmed by trustworthy documents, were made in this country in the second decade of the last century. In 1818, the ruler of Wallachia, Prince Caragea, and a crowd of several thousand citizens, gathered on the hill called Dealul Spirii in Bucharest, watched the flight of an 8-m diameter hot-air balloon. In view of the fact that the experiment took place only 35 years after the ascent of the first free balloon in the world, and that air navigation was still in its infancy, this was a remarkable event.

The first Romanian achievements as regards heavier-than-air machines were contemporaneous with those in the world at large. In 1875, physical training instructor *Spinzi*, of Jassy, took off in a glider designed by *Grigore Sturza* from a tower in the village of Cristineşti. Although he crashed, this was one of the first glider flights in the history of Romanian aviation and seems to be one of the first in the world.

Remarkable airplane models were made in this country during the pioneering period between the years 1884 and 1900 by *Ion Stoica* of Ormindea, a village 18 km north of Deva. One of these models, presented at a successful demonstration flight before a large crowd, had rigid wings and two contrarotating airscrews, and another model had flapping wings.\*

Specialized literature published throughout the world records numerous attempts to build flying machines. Most of them, lacking the necessary scientific substantiation, resulted in freaks, leading to failure and very often to fatal accidents.

The first heavier-than-air machines that really succeeded in flying were built at the beginning of the 20th century.

\* Dr. I. Radu, *Un zburător — Ion Stoica* (A Flyer, Ion Stoica), in the volume *Album Vlaicu*, Orăştie, 1920, pp. 231-238.





*"It does not matter who has made a thing. What is important is that it exists, that it has been made. I have never pursued glory, because I know that glory often ruins a man. I do not work for my personal glory, I work for the glory of mankind."*

TRAIAN VUIA



*"I would consider myself more than fully rewarded for my fourteen years of labour, apprehensions and torturing hopes if I knew that I have done something, even a little, for the progress of science and for the happiness of people."*

AUREL VLAICU

Among the daring pioneers whose achievements in the first years opened the "era of aeronautics" were the Romanians *Traian Vuia*, *Henri Coandă* and *Aurel Vlaicu*, co-founders of Romanian and world aviation. The creative work of **Traian Vuia** in aircraft construction was revolutionary and decisive because it blazed the trail for progress in world aviation.

Traian Vuia carried out his historic flight on *March 18, 1906*, with a plane designed, built and piloted by him. Taking off from a country road, Vuia's machine ran on the wheels of its undercarriage until it gained the speed needed to leave the ground. The merit of Traian Vuia was increased by the fact that, unlike other constructors, he did not use inclined launching sites or unwieldy and complicated auxiliary machinery such as the catapult with which the Americans *Orville* and *Wilbur Wright* launched their plane on December 17, 1903. Orville and Wilbur Wright had only found a partial solution to the problem of flying with heavier-than-air machines because their plane did not take off under its own power; it used an auxiliary starting installation that remained on the soil.

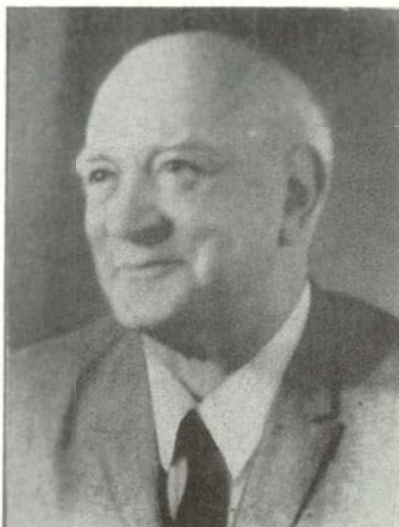

Vuia's example was soon followed by other builders who imitated the undercarriage he had used. The first to do so was *Alberto Santos-Dumont* who flew in September 1906. In the memoir Traian Vuia had presented in 1903 to the Academy of Sciences of Paris on the design of his first plane, he had explained what he understood by a full solution of the problem of flying with heavier-than-air planes.\* Vuia said that such a flight would be possible only if "*a machine is built that has an engine powering an air-screw for the propulsion of the machine, capable of leaving the soil exclusively under its own power, and of being conducted in full safety, according to the pilot's will, in any direction.*" Moreover, he defined and mathematically determined the three factors he believed to be essential for the success of flights with heavier-than-air machines: the minimum horizontal speed required for a secure lift, the ratio between the weight of the aeroplane and the power of the engine, and the stability conditions in the air. The theoretical studies and successful experiments made by Traian Vuia, together with other achievements of his time, therefore belong to the vanguard exploits leading to the emergence and development of world aviation. Constantly seeking new solutions for the flight of heavier-than-air machines, Vuia also tackled the problem of helicopters. In 1919 he published in Paris a paper entitled *Etudes expérimentales sur les plans inclinés en rotation* in which he expounded his views on the flying principles of this type of aircraft. In contradistinction to the dominant opinion of the time, according to which the lift and propulsion of helicopters could only be obtained by separate organs, Traian Vuia believed — and the subsequent evolution of helicopters confirmed his belief — that a rotary wing (lifting propeller)

\* *Annales de l'Académie des sciences*, tome CXXXVI, no. 7, 16 février 1903, Paris.



Front page of *The New York Herald* featuring the flight made by Traian Vuia on March 18, 1906.

could best secure both lift and propulsion. He applied this principle to the two helicopters he built in 1918 and 1921 which he called *machines with rotating wings* and whose tests gave promising results.

Concerning himself with the construction of a simple, highly efficient, powerful and economical aircraft engine, Vuia made another great invention: the well-known steam generator bearing his name. In France the utilization of this generator for aircraft was studied by the *Brequet* company which, in 1942, designed a turboprop fighter with a 1,200-HP reactor turbine powered by a *Vuia*-type generator. In Romania the idea of building such a generator was taken up by the Energetics Institute of the Romanian Academy, which built a *Vuia* methane-gas fuelled generator and exhibited it on May 8, 1954, at the Technical Documentation Centre in Liberty Park, Bucharest.

The inventiveness and the new and original ideas of Traian Vuia placed him among the great men of our people and made him one of the trail-blazers of progress in world aviation.

If world priority in mechanical flying with incorporated take-off and landing means (aircraft with airscrew and classical engine) belongs to Traian Vuia, the priority in jet flying (aircraft without propeller, powered by a reaction engine) also belongs to a Romanian, the famous scientist and inventor *Henri Coandă*.

*Henri Coandă* began to study jet propulsion as far back as 1905 when, as a young artillery second lieutenant, he designed, built and tested several rockets. At the same time, at the Army Arsenal of Bucharest he built the mock-up of a jet-powered aircraft.



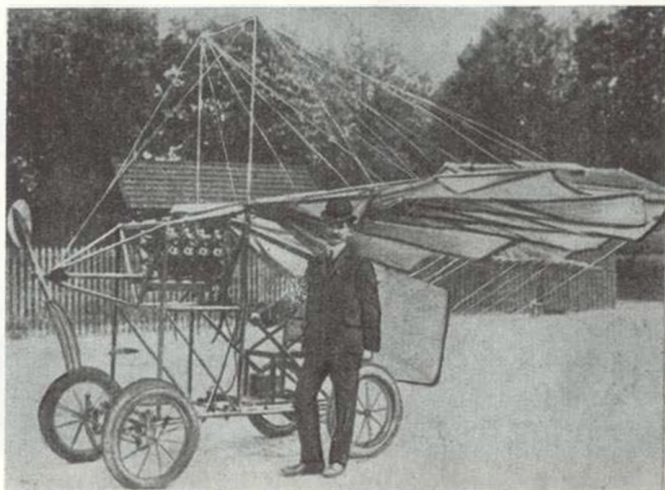

Traian Vuia with his second aeroplane.

Later, at Liège, Coandă constructed an original glider for the aviation contest to be held in September 1909 at Spa, near Liège. Commenting on that plane, a local paper wrote: "The likeable Romanian aviator Coandă, who gave such interesting lectures last winter at the Aeroclub of Liège-Spa, is about to complete a new glider. It is a biplane with very elegant lines, and its most remarkable feature is a special device through which both the rudder and the elevator are operated through the same control lever. . . ."\* The article continues by saying that the first flights would be made with the launch of the glider by towing with the assistance of a car. Coandă had provided for the possibility that a small power engine could be mounted on the glider.

Whilst pursuing his studies at Montefiore, Henri Coandă built, in collaboration with Gianni Caproni, one of the pioneers of Italian aviation, a glider with which several flights were made.

In Paris, Coandă attended the Higher School of Aeronautics. At that time he constructed a plane which he presented at the second international aeronautical Salon held in the French capital in 1910. On that occasion the famous engineer Gustave Eiffel, the man who built the Eiffel Tower, examined the unusual aircraft and told Coandă: "What a pity, young man, that you were born thirty or possibly fifty years too soon!" He was right, because the next reaction-propelled planes were only built thirty years later, in 1939-1941, by the German Heinkel, the Italians Caproni and Campini, and the Briton Whittle.

\* *L'Express*, Liège, September 16, 1909, p. 3.

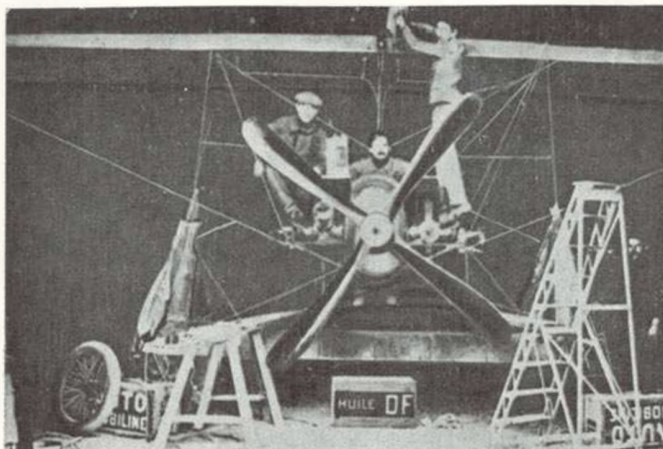

The *Coandă biplane*, which participated in the military aircraft competition of Reims, France, in 1914. Pilot Boutmy is seen in the cockpit (from the Henry Beaubois collection).

A *Bristol-Coandă plane* on Cotroceni airfield. The crew consisted of Captain Andrei Popovici and Lieutenant Gheorghe Negrescu (in the front seat).

Coandă explained the revolutionary concept on which he based the construction of his plane, which had no propeller, at that time believed to be indispensable for flying, in the review *La Technique Aéronautique*. This is what he wrote in 1911:

"... aviation still is in an absolutely rudimentary stage, the same stage as three years ago... What prevents progress is the fact that aeroplanes are considered from a viewpoint which totally differs from the one I believe to be the correct point of view... The present aircrews can be likened to the wings of a windmill; these have a miserable efficiency despite their enormous dimensions." And in an interview given to the British magazine *Flight*, in May 1956, Henri Coandă declared:

"From the very start I wanted to eliminate the current ideas according to which an airscrew was indispensable... It was my intention to use a turbo-prop\* in order to drive the air in front of the engine backwards through a circular hole."

The ideas leading Coandă to the first construction of a jet plane in the world were based on thorough studies, research and experiment. Having no aerodynamic tunnel at his disposal, Coandă, with the assistance of Eiffel, Painlevé and Sertrieux, tested various profiles of his future aircraft using a test stand mounted on a platform placed in front of a locomotive travelling at a speed of nearly 100 km/h. The test stand had a device designed by Coandă which established, measured and recorded the effects produced by air drag on the profiles that were being tested. It was in the course of these experiments that he discovered the slot effect at the wing's leading edge. The results of these interesting studies and experiments were presented by Henri Coandă in an article which made quite a sensation.

\* It is quite evident that Coandă used the term in a different sense than the one current nowadays.



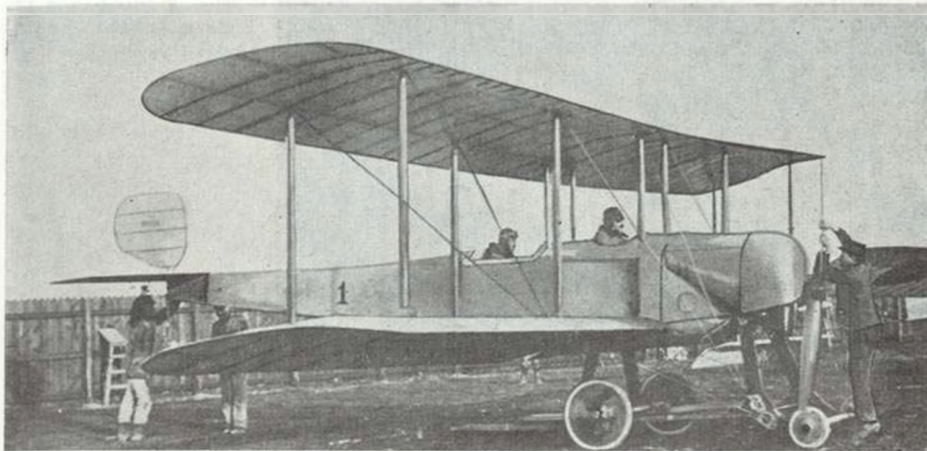

In keeping with the technical terminology of the time, it was entitled "The Wings Considered as Reaction Machines," and it was published in the July 1910 issue of the review *La Technique Aéronautique*.

The first flight test of the new kind of plane, piloted by its constructor, took place on the field of Issy-les-Moulineaux on December 16, 1910. The plane took off, but the flight ended in an accident, during which the machine was damaged.

In 1911 Coandă built a new type of aircraft, a biplane with two rotary engines, with which he participated in the military aircraft contest of Reims in November 1911, whose entries included machines of the most famous aircraft constructors of the time, among them Blériot, Latham, Voisin, Nieuport, Bréguet a.o. This plane, flown by the French pilot E. Boutmy, was noted by the specialists, as reported in the review *L'Aérophile* of November 1, 1911 (pp. 502-503), which wrote:

"The Coandă biplane obviously presents the greatest number of novelties; in addition to certain rather daring devices, it also has ingenious innovations. . . From the angle of the improvements aviation may expect from this contest, the Coandă biplane is a highly interesting machine."

The review mentioned that many aircraft constructors had tried to manufacture two-engined planes, but did not find a satisfactory solution. The two 70-HP Gnome engines of the twin-engined *Coandă* were mounted in the fuselage, one facing the other, with their axes of symmetry at right angles to the flight course of the plane, both of them powering a single four-blade propeller by means of a differential device. The original structural solutions of this machine included a sesquiplane wings formula with a single nickel-steel spar, nose ribs at the leading edge of the highly dimensioned wings (which the inventor called "turbine profile") and a partially retractable landing gear.

Henri Coandă's contribution to aircraft construction, climaxed by the manufacture of a reaction-propelled plane in 1910, brought him world fame. As

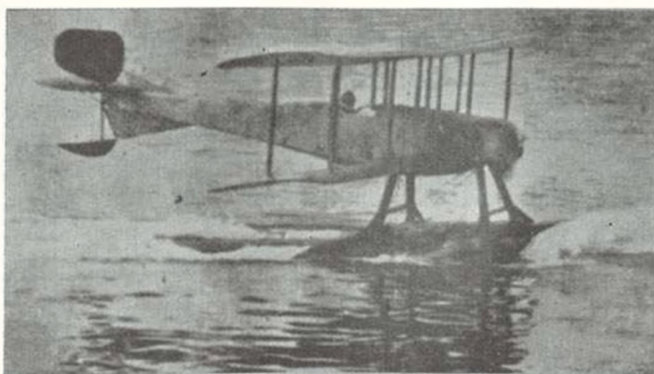

The *Bristol-Coandă* biplane in the hydroplane variant.

a result, the British and Colonial Aeroplane Company, later named *Bristol*, appointed him chief-engineer. During that period Coandă designed several monoplanes and biplanes which were built at the Filton factory. Notable among these were the *Bristol-Coandă* monoplane with a four-wheel landing gear, with brakes, which won the *British Military Aviation Trials* on Salisbury Plain and which was on show at the Paris Aeronautical Salon in 1912,\* as well as an improved machine derived from this monoplane. Another entry at the Salisbury Plain Trials was a *Bristol-Coandă* biplane powered by a 70-HP eight-cylinder Renault engine. This machine had an interesting reduction gear, invented by Coandă, which replaced the crankshaft with a camshaft, thus halving the rotation rate of the propeller (900 rpm), as against the engine's 1,800 rpm.

A *Bristol-Coandă* monoplane of that type, with an 80-HP Gnome rotary engine was bought by the Romanian Air Force. In September 1912 Henri Coandă came to Bucharest and watched the presentation flights of that plane, flown by the British pilot Pixton, and afterwards by Air Force Lieutenant Ștefan Protopopescu. The following year, Air Force Lieutenant Andrei Popovici went to Britain for the purpose of buying planes for our Air Force. Several *Bristol-Coandă* biplanes, surnamed "tractors," were bought by Romania.

On returning to France at the beginning of the first world war, Coandă was commissioned to make the designs for an artillery liaison aircraft. Coandă built the machine, which was tested by Charles Weymann. Transferred to the Delaunay-Belleville factory, Coandă designed and built new types of combat and bomber aircraft, the most noteworthy being the Coandă S.I.A. of 1916. The upper wing of this machine had a pronounced dihedral, and the engine powered two pusher propellers placed at the rear part of the fuselage; this position of the propellers made for excellent visibility. During that period Henri Coandă also built a recoilless aircraft cannon and finalized a light rocket launching device for fighter planes as well as sighting instruments adapted to bomb and air torpedo launching devices.

\* *Flight*, November 2, 1912, p. 997, and *The Aeroplane*, November 27, 1912, pp. 468-469.



The *Coandă* monoplane, placed first at the Salisbury Plain Trials.



The Romanian scientist won world fame for the discovery of a phenomenon which is now known as the Coandă Effect. He discovered it in 1910 whilst piloting his first aircraft. Patented in France in 1934, and in Romania in 1938,\* this discovery has numerous applications in a great variety of fields.\*\*

The appreciation of the entire creative work of Henri Coandă, an indubitable pioneer of jet flying, was eloquently voiced at the festive meeting held in 1956 in New York, organized for his celebration: "Engineer Coandă symbolizes the past, present and future of progress in the air by his person."

History has given Aurel Vlaicu, a well-deserved place in the ranks of the pioneers of aviation. He won it for his brilliant performances as a pilot and for the originality and novelty of his aircraft designs and constructions. Here are some of the original elements of Vlaicu's airplanes:

the variable wing profile, depending on the angle of incidence and speed (the wing was without ribs and had a flexible cover which, under the action of the air spins, found the most suitable foil during the flight);

the suspension of the nacelle, with the engine under the wings, secured the stability of the plane which returned, without any intervention by the pilot, to the normal flying position when it was upset by air streams;

this was a very original solution of the problem of inclination, without the use of ailerons, of the aircraft at turns;

an improved light-weight landing gear, one of the first in the world having independent wheels;

\* Ing. I. Iacovachi, *Opera savantului român Henri Coandă reflectată în brevete* (The Work of the Romanian Scientist Henri Coandă as Reflected in Patents) in *Revista Transporturilor*, no. 8, 1968, pp. 359-365 and no. 11-12, 1968, pp. 517-533

\*\* Dr. C. Teodorescu Țintea, *Efectul Coandă în tehnica modernă* (The Coandă Effect in Modern Technique), in the review *Știință și Tehnică*, no.2, 1967, pp. 10-11; *Cercetători din toată lumea studiază efectul Coandă* (Research Workers throughout the World Study the Coandă Effect), in *Flacăra*, no. 4, 1967, p. 10.



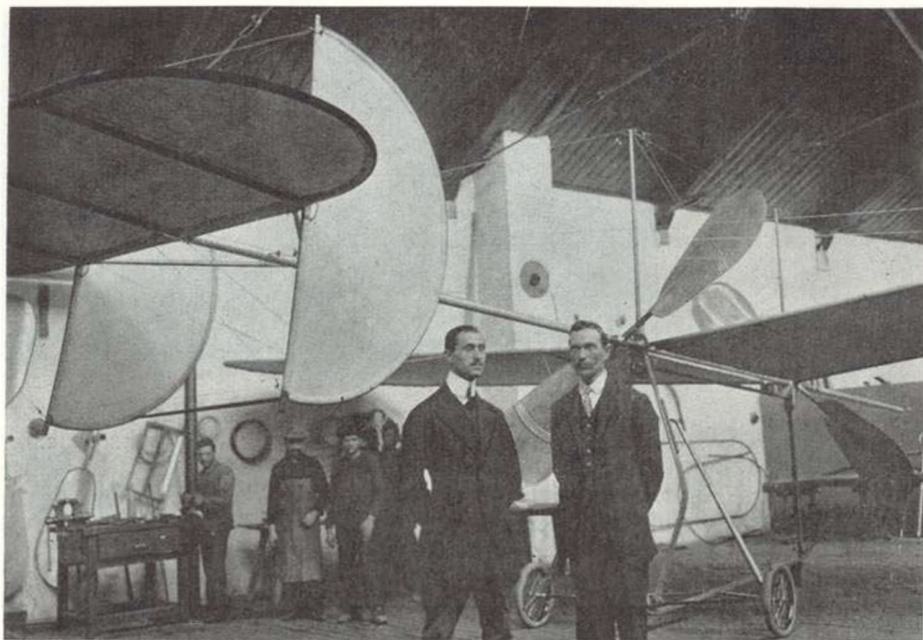

two tandem airscrews (a tractive one and a pusher one) to increase the thrust and annul the gyroscopic and bunt torques;

a fine aerodynamic form and an almost all-metal structure (in the case of the *A. Vlaicu No. III* plane).

The entire design (with frontal stabilizing piece, a rear tail unit and a pendular self-stabilizing system) gave the Vlaicu aircraft special handling qualities, which enabled the pilot to carry out very close turns.

Aurel Vlaicu built his first plane after the design of his most successful flying model which he had begun to construct during his childhood. It was a glider, called *Aurel Vlaicu 1909* and built in his native village of Bințiți (now renamed Aurel Vlaicu) immediately after returning home from his years of study abroad. Vlaicu made several successful flights with that glider.

After coming to Bucharest, Vlaicu built two aircraft, the *A. Vlaicu No. I* and *A. Vlaicu No. II*, and learned to fly. He was the first Romanian aircraft constructor and pilot to fly in this country with a Romanian-made plane.

The aircraft designed and built by Aurel Vlaicu were better than foreign-made machines in several respects. The interest aroused by the original structure and high flying qualities of the *A. Vlaicu No. II*, noted at the Aspern contest of 1912, is borne out by the offer the British *Marcni* Company made to Vlaicu to manufacture his plane, with certain modifications and improvements, in serial production. That plane was to be

←  
Aurel Vlaicu at the time his first plane was built in the hangar of Cotroceni.



Aurel Vlaicu (x) on a *Farman* plane with Gheorghe Negrescu, on the field of Cotroceni in 1912. Lieutenant Ștefan Protopopescu is standing in front of the plane.

called the *A. Vlaicu No. III*. Vlaicu refused, and he also refused to sell the licence because he wanted to keep the right to use the plane for his country. "Eventually Vlaicu succeeded in stipulating that the British company should build in Britain only the aggregates and pieces that could not be made in Romania, and that production and assembly workshops should be set up in Romania for the remainder of the plane."\* The untimely death of Vlaicu put an end to the project. Whilst trying to carry out his great dream of crossing the Carpathians, Aurel Vlaicu crashed on September 13, 1913.

In 1911 the Ministry of War placed an order with the workshops of the flying school of Chitila, founded by *Mihail Cerchez*, for the manufacture under licence of four *Farman* aircraft. In 1912 another four *Farman* planes were built by the workshop of our first Air Force flying school, which had been established at Cotroceni.

The flights of Vlaicu and of the first Romanian flyers trained in 1911-1912 at the flying schools of Chitila, Cotroceni and Băneasa aroused great interest in aviation throughout the country and attracted many inventors to aircraft construction. Just as in other countries, some of those inventors,

\* Gheorghe Costescu, *Inceputurile aviației române* (The Beginnings of Romanian Aviation), Bucharest, 1944.



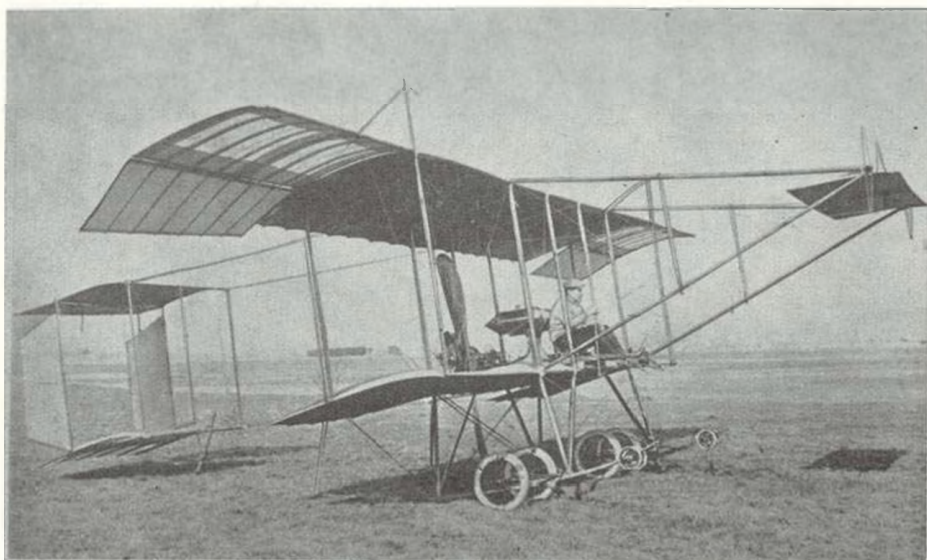

A *Farman* plane built at the Chitila flying school.

having no suitable scientific and technical education, conceived and designed fantastic flying machines, based on unscientific or unreal flying principles. But there also were scientifically well-substantiated projects, some of them with original principles and devices, which could not be carried out because they did not find the necessary financial backing.

In this context of the period before the first world war, we would like to recall some of the peak achievements in aircraft construction which, in the absence of suitable reference material, we were unable to include in the second part of this volume.

In 1909, **Rodrig Goliescu**, at the time an artillery lieutenant, worked out several highly original principles regarding the flight of heavier-than-air machines. The novelty of his ideas, which materialized in the construction of an original flying machine called the *Goliescu Avioplan*, resided in the following:

a tubular fuselage through which the air stream produced by the propeller was flowing; this resulted in an additional thrust, as well as in a reduction of drag, and in a growth of lift at certain angles of incidence of the fuselage;

the blending of the characteristic features of the tubular fuselage and of certain devices derived from the flying system of the coleopters; the fairing of the propeller, in order to increase its efficiency; Goliescu did not, however, apply this idea to his machines.

In 1909 Rodrig Goliescu completed his tubular fuselage *Avioplan* in the form of a model, with an engine powered by a rubber turnbuckle that was

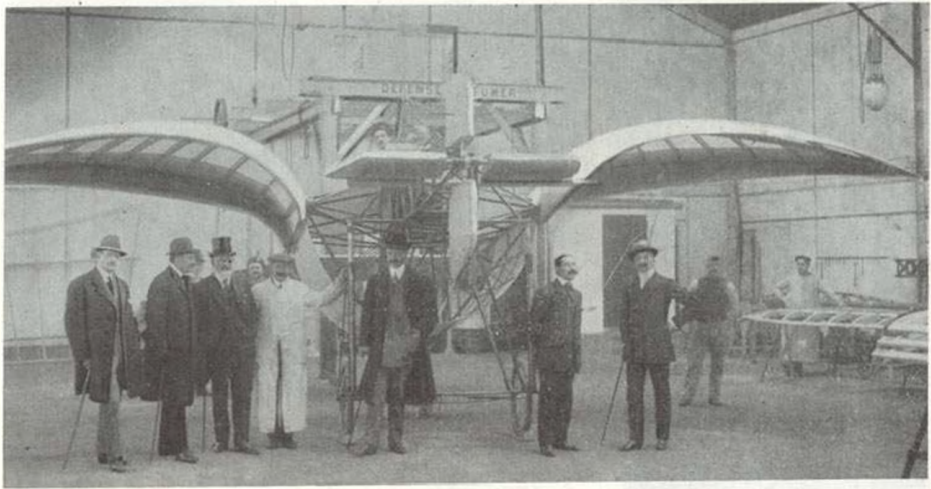

The Goliescu Avioplan in the hangar of Juvisy, after inspection by a commission of the Aeroclub of France (Paris, 1909).

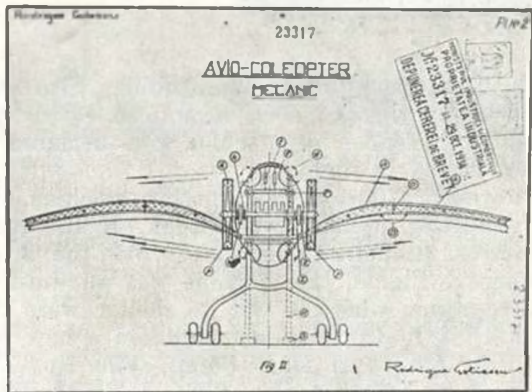

Sketch of the Goliescu Aviocoleopter in the patent file of Goliescu's invention.

as long as the 1.20 m sized fuselage. After studying aeronautical constructions in Berlin and London, Goliescu left for Paris where he again tested the models of his Avioplan. Following these experiments, he summed up his ideas regarding the flying principles of his machine in a memorandum which he submitted to the Paris Academy of Sciences under the title "The Laws of the Dynamism of Various Aerial Media," which was also printed in the review *La France automobile et aerienn*e of May 15, 1909. In France, Goliescu patented his invention which he called a *flying machine-avioplan*. Unlike the previous models, that machine had above the tubular fuselage a relatively small wing in the form of an upturned V, with a foil having a pronounced curve at the leading edge. The three-wheel landing gear was similar to the tricycle of present-day aircraft. Afterwards Rodrig Goliescu succeeded in building his aircraft, but in doing so he applied only some of the principles which he had tested with his models. For instance,



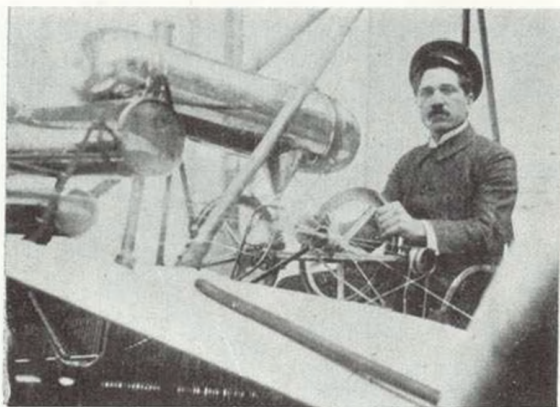

RODRIG GOLIESCU.

NICOLAE SARU-IONESCU.

the fuselage, although semi-tubular, also served to absorb the stream produced by the propeller. Examined by a special commission of the Aero-club of France, his machine was declared to be satisfactory, but it was not tested in flight.

However, Goliescu flew another machine, the *Avioplan No. II*, with a semi-cylindrical fuselage, which took off and reached a height of about 50 metres. Brought to Bucharest with the intention of continuing the experimental flights, the machine was put into one of the sheds of the Chitila aerodrome, where it and its shelter were destroyed by a powerful storm. In 1934 Rodrig Goliescu patented a new type of flying machine (State Office for Inventions, Patent File No. 23,317) with a tubular fuselage, which he called *Aviocolopter*. It had a set of lateral airscrews, deflectors and various devices whose purpose was to reproduce the flight of the coleoptera as far as possible. Adopting the principles of Goliescu, the French mechanic Jourdan built a tubular fuselage flying machine in 1911 and tested it on the aerodrome of Juvisy. In 1920, Professor Knoller of the Technical University of Vienna also experimented with tubular fuselages and confirmed their qualities, and in 1932 the Italian engineer Stipa built a "barrel-plane," so called because of the form of the fuselage which was a variant of the tubular fuselage, once again demonstrating the features first propounded by Rodrig Goliescu.

The idea of building *coleopter aircraft*, first put forward by Rodrig Goliescu, is still topical, and it is applied to the construction of certain experimental aircraft.

Ion Paulat, chief mechanic on the river ship *Turnu Severin*, installed a small aerodynamic tunnel on board that craft in which he tested aerofoils with a view to building a twin-engined seaplane. Although Paulat completed





DUMITRU (TACHE)  
BRUMĂRESCU.



ION PAULAT.



Major ȘTEFAN PROTOPOPESCU,  
B. SC., Aeron. Eng.

the design in 1910, he only built the machine the following year. The three-seat biplane amphibious seaplane had an almost entirely retractable landing gear; with this one Paulat made several runs on a field near the town of Galați. However, these tests were not conclusive; they were made with only one engine because Paulat did not succeed in procuring the second power plant. In 1911 Ion Paulat designed a single-engine one-seater monoplane with which he made flights at a height of about 8 metres over a distance of several hundred metres on a field between Galați and the village of Barboși.

On July 6, 1911, at a public flight demonstration organized for the purpose of collecting money that would enable him to buy the second engine for his seaplane, Paulat seriously damaged his monoplane when landing. After the accident this aircraft constructor found himself moneyless and discontinued his meritorious activity as an inventor and pilot.

The value of the ideas applied by Ion Paulat to the construction of his seaplane designed in 1910 results from a comparison with the first seaplane of the world, built by the Frenchman Henry Fabre, who took off from the Lake of Berre in France on March 28, 1910. In that seaplane having three floats but no fuselage, with a front placed tail unit and the engine at the rear, the pilot sat on the central spar of the machine. As to the first flying-boats, they were presented only in 1912 by Curtiss of the USA and Denhaut of France.

Although the Paulat aircraft, with its almost classical form and fuselage, did not fly because its second engine was missing, it certainly was one of the first flying-boats in the world.

Another Romanian aircraft constructor of the pioneering days of aviation was Ștefan Alămaru, a mechanic of Brăila, who built an interesting biplane

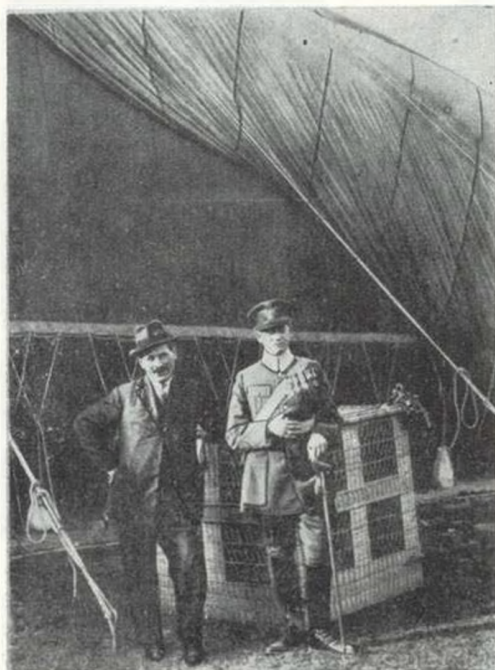

Major Scarlat Rădulescu with foreman Iliescu in front of a captive balloon on the field of Pantelimon, Bucharest.

glider in 1909 with which he carried out sailed descents on the hills near Măcin. Another attempt was made on June 13, 1909, by Carol Faludy, an actor of Arad, who built a flying machine after his own design.

Also in 1909, Engineer **Constantin Gheorghiu** of Bucharest, a graduate of the High School of Aeronautics of Paris, designed a machine whose model was successfully tested.

Between 1910 and 1911, **Emil Măldărescu**, a teacher of engines and electricity at a school in Cimpina, designed and built a biplane, which he did not succeed in testing in the air.

In 1911 another passionate aviator, **Nicolae Saru-Ionescu**, flew a plane of his own design and construction on the field of Cotroceni.

**Grigore Brișcu** built the mock-up of a helicopter after his own daring formula. The machine had two co-axial airscrews, with the control of horizontal flight by a device which he called the cyclic variation plate. This device, invented by Brișcu in 1911, is now used in an improved form by many modern helicopters. \* Brișcu also built the model of a helicopter for passenger transport, which he called *Aerobrișcă* (aerial tillbury).

\* Constantin Sabin Ioan, *Elicopterul* (The Helicopter), Bucharest, 1966, p. 169.



Ion Romanescu was another remarkable pioneer of Romanian aviation. His short career as a pilot came to an end in 1916, when he was shot down during an air battle on the Western front, over Verdun. He began to build flying machines in 1908 when he was a second-form pupil at secondary school. His machine had the principles and structure of a kite, with which he succeeded in rising several metres. Photographs of the attempt were sent to the Aeronautical Federation, in Paris, whose secretary, Captain Ferber, said in his reply: "... up to this hour you are the youngest flyer in the world." In 1911 Ion Romanescu built his first glider, with which he made several flights from the hills near the seaside resort of Movilă, now known as Eforie Sud. A pupil of the Costache Negruzzi secondary school in Jassy, Romanescu set up the first glider club in this country, where he built another two types of gliders in 1912 and continued his experimental flights. One of the participants in these experiments was **Horia Hulubei**, a friend and colleague of his and a member of the flying club, who also became a pilot in the first world war and then made his way as a world-famous scientist. In 1912 Ion Romanescu built a fourth type of glider after his own design, a biplane with a frontal elevator. But he changed this arrangement when he built his last machine, also a biplane, which he called "H. Rallet 5." This plane was used by gliding enthusiasts to make successful flights from Copou Hill, near Jassy, or towed by a motor car. As regards *lighter-than-air machines*, their development in this country had its starting point in the oldest Romanian project of a dirigible balloon, put forward in 1883 in France by Captain **Gheorghe Ferechide**.<sup>\*</sup> He did so even before the first closed circuit flight, carried out on August 9, 1884, over a distance of 7.6 km with the dirigible La France by its builders, the French captains Charles Renard and Krebs.

Only captive balloons for military purposes were built in Romania in the workshops of the Balloon Group of Pantelimon. The first Romanian captive balloons were built in August 1924 by Major **Scarlat Rădulescu** and foreman **Iliescu**, who improved the French Caquot model.<sup>\*\*</sup> Since aerostats were on the decline, their role being gradually taken over by aviation, the manufacture of balloons was discontinued in this country.

In addition to the men mentioned in this brief outline of the start of Romanian aviation up to the eve of the first world war, there were several other inventors who had ideas as regards the building of flying machines. Only some of them patented their inventions. Others were mentioned by the newspapers of the time, and some have remained anonymous. Whatever their technical level, those projects are meaningful for the history of Romanian aviation because, together with other valuable achievements, they reflect the creative talent of the people, their interest in everything that is new and courageous — as flying has been and continues to be.

<sup>\*</sup> Jean Lecornu, *La Navigation aérienne*, Paris, 1912, p. 292.

<sup>\*\*</sup> *Primul balon captiv construit în țară* (The First Captive Balloon Built in this Country) in *Aeronautica Română*, second year, p. 356.

## PRIVATE VENTURE AIRCRAFT CONSTRUCTIONS BEFORE AND AFTER THE EMERGENCE OF THE ROMANIAN AERONAUTICAL INDUSTRY

In 1921-1922, Engineer Professor **George de Bothezat**, who settled in the United States after the first world war, built a helicopter after his own design at Dayton (Ohio). The machine had four rotors (the diameter of each being of 7.62 m), mounted on a cross formed aluminium chassis and was powered, through several reductors, by a 170-HP rotary Gnome-Rhône engine. Every rotor had six variable incidence blades. The total weight of the helicopter amounted to 1,650 kg. The first flight was carried out on December 18, 1922, when the helicopter reached a height of some 1.80 m, and maintained itself in the air one minute and 42 secs. During another flight, also at Dayton, on January 19, 1923, the helicopter of George de Bothezat, with two passengers on board, rose to a height of 1.22 m, and on February 21, 1923 it rose to a height of 4.50 m and remained in the air for 2 min. 45 secs.\* Despite the promising results, the experimental flights were discontinued because they proved to be too expensive for the inventor. In 1923, college teacher **Stan Mateescu** of Bucharest designed and built an interesting machine which he patented that year. Called *Giropter*, it had two lifting propellers (on vertical axles) powered by an 80-HP Gnome engine, and a tractor airscrew powered by a 35-HP Anzani engine. The length of the giropter's fuselage was 10 m and its height 2.80 m. The field diameter of the two lifting propellers was 10 m and 6 m respectively. The weight of the machine amounted to 850 kg.

Between 1929 and 1931, **Egon Pastior** built two gliders after his own design, at Sibiu. They were used by the glider circle of the town. In 1935 Pastior built a Zögling glider at the sports association of the wage-earners of the

\* L. Hirschauer and C. Dollfus, *L'année aéronautique, 1922-1923*, Paris, 1923, p. 50; Charles Dollfus and Henri Bouché, *Histoire de l'Aéronautique*, Paris, 1932, page 377; A. Van Hooerebeek, *La conquête de l'air*, Verviers, 1967, pp. 152-153.





The helicopter of Engineer George de Bothezat during a test flight.

U.D.R. works, of Reșița. That year he also built a Grünau Baby I glider at Sibiu. With it he carried out a two-hour flight (after launching) at a height of 1,500 m.

One of the aircraft constructors of that period was the Romanian engineer **George Fernic**. In 1921-1922, whilst studying in Germany, he built his first machine, of which no technical data are available today. Returning from his studies in 1923, Fernic wanted to work in aircraft construction. He intended to bring to Romania the equipment of the *Deutscher Lloyd Flugzeugwerke* which he had bought. Unable to carry out his plan, Fernic left for the United States, where he designed and built several types of aircraft. The best known among them, a unique machine as to form and highly original as to its aerodynamics, was the *Fernic IX*, a monoplane with two 220-HP Wright-Whirlwind engines, which he completed in 1929. Fernic, who had a pilot's licence, intended to carry out a long-range flight over the New York-Bucharest-New York route. The unusual form of the aircraft and the plans for its flight became a topic of the day, about which many articles were printed in the American press, in the Romanian papers published in the United States and in Romania. Here is a report of the Romanian News Agency published in the Bucharest papers:

“New York, September 12 (Rador). Yesterday the Romanian flyer Fernic carried out a first test flight with a plane of a new type built after his own design on which he has been working for several years. The press considers that flight to be of fundamental importance. The *New York Times* writes that more than 100 skeptical aviators came to watch, believing that the strange two-winged tandem would not be able to take off. But they were enthusiastic when Fernic made his start, carrying out a perfect flight at a height of 500 metres for nearly half an hour. The *World* points out that Fernic had such great confidence in his machine that he refused to take a





Engineer  
GEORGE DE BOTHEZAT.



Engineer  
STANISLAS SEŞEFSKI.



Engineer  
RADU STOIKA.

parachute with him, which is normally a must on maiden flights even on well-known machines."

"The new system of landing on three wheels and the other daring innovations were highly impressive," reported an item printed by the newspaper *Cuvintul* for September 14, 1929, under the headline "Flying from New York to Bucharest, Successful First Test of the Romanian Aviator Fernic."

The courageous plan was not carried out. An accident during a flight on October 22, 1930, with another plane of his own design, the *Cruisair*, led to the untimely death of the remarkable aircraft constructor and pilot George Fernic.

The gliders built by Ion Bărboi also deserve attention. In 1932 he built a glider at Orăştie, after the American glider Mead Challenger, which he tested in flight, being towed by a car.

In 1934 Bărboi built another glider of the same type, which had several essential changes in the controls, the launching gear and the webs of the

**PLANS FLIGHT**

**RUMANIAN AIR HERO PLANS HOP OVER ATLANTIC**

Lieut. Fernic, Guest Here, Tells of Proposed Flight to Bucharest

A 3,000-mile airplane flight from New York to Bucharest will be an unaccompanied feat, as announced by George G. Fernic, Romanian aviator and World War hero, who is guest here of John C. Foye, Romanian consul, at 2400 Park Manor.

The flight will be made in a two-engine airplane, built by Fernic's design, and in course of construction at a plant at Bermuda.

... over Bermuda, north of the Azores, reaching the European coast at the Paris-Bucharest point. It then will follow the Pyrenees south of the Alps, over the Adriatic and along the coast of the Danube to Bucharest.

Fernic said the plane would be completed in July and that he planned test flights to Washington, Cleveland, Detroit and possibly Chicago. He will be accompanied on the Bucharest flight by an American navigator who will be designated by W. P. McCracken, assistant secretary of commerce.

**Who Would Go**

Mrs. Fernic, who accompanied her father-in-law to Cleveland, hopes to make the flight, too, even if Fernic does object.

"Maybe I can draw in at the last moment," Mrs. Fernic said.

The plane is of original design, built and powered by two Virgin-Whitcomb motors, and will be launched from the deck of a ship at Bermuda. The forward wing will

Clipping from *The Cleveland Press* reporting George Fernic's plan to cross the Atlantic Ocean from New York to Bucharest.



Engineer  
GEORGE FERNIC.



FILIP MIHAIL.



GEORGE POPOIU.

wings. The glider had a wing span of 12 m and a wing area of 18 sq m. The safety coefficient was 7.

It was during that period that the foundations of an aeronautical industry were laid in this country. However, several passionate aircraft builders and pilots constructed gliders and light aircraft after their own designs. It should be noted that they worked in very difficult conditions. The component parts were made in various workshops and the engines and instruments had to be bought with their own money.

In 1926-1936, Engineer Radu Onciul built three types of machines. The first was called Ra. Bo., named after the first syllables of the Christian names of Radu Onciul and his co-worker Engineer Bo Carlson; the second and the third aircraft were the *R.O.-1* and *R.O.-2*. The Ra.Bo. was on show at the 1927 international aviation exhibition in Prague.

An entire series of gliders and aircraft carrying the initials R.M., after their constructor, Engineer Radu Manicatide, illustrates the intensive activity

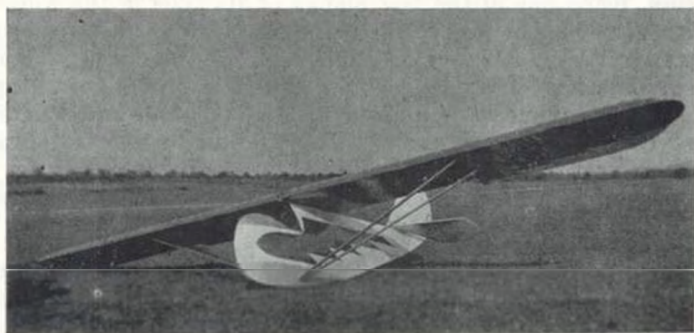

One of the  
gliders built  
by Ion Bărboi.





The Romanian stand at the Prague 1927 International Aviation Exhibition. In the foreground the *Ra.Bo.* plane.



The light airplane built by Captain Dionisie Nichifor in 1935.

of that pioneer over a period of 40 years. His merits were acknowledged by the award of the Paul Tissandier Diploma, given to him by the International Aeronautical Federation. Radu Manicatide's first glider, the *R.M.-1*, built in 1926, won first place at the national competition of engineless flying machines. The most remarkable achievements of the series, which

we present in full in the second part of this volume, were the *R.M.-10* glider and the *R.M.-11* aircraft.

Highly original for its time was the small plane built in 1933 by Filip Mihail. Its constructor called it *Stabiloplan*. Filip Mihail's aircraft flew for many years, being one of the few planes of its type in the world.

Three light airplanes typical of the thirties were designed and built by flying fans. In 1935, Air Force Captain Dionisie Nichifor, and in 1939 Ion Dumbravă, both of Jassy, and Air Force Captain Grigore Mușică in Bucharest, all three having very limited means, succeeded in building machines that proved to be of real quality. This in one of the best examples illustrating the general technical level of aviation — and especially of aircraft construction — that was characteristic of Romania in the years preceding the outbreak of the second world war.

# ROMANIA'S AERONAUTICAL INDUSTRY, BEGINNINGS AND DEVELOPMENT

## AEROPLANES

Following Romania's entry into the first world war, the workshops of the military flying school of Cotroceni (Bucharest) were moved to Jassy, where, under the name of **Rezerva Generală a Aviației — R.G.A.** (General Air Force Reserve), it met the combat requirements of our Air Force.

In 1917-1918, *R.G.A.* reconditioned and assembled all the aircraft received from France. Moreover, and this was a remarkable feat considering the working conditions and the equipment at its disposal, *R.G.A.* repaired 292 aircraft degraded or damaged in combat. *R.G.A.* also repaired and re-commissioned 545 aircraft engines.

In 1919, after the end of hostilities, all the plant and technical personnel of *R.G.A.* were transferred from Jassy to Bucharest, where the **Arsenalul Aeronautic** (Aeronautical Arsenal) was set up on the field of Cotroceni. In 1922 the *Arsenalul Aeronautic* began the serial construction of the German two-seater *Brandenburg* observation and reconnaissance plane, powered by a 160 HP Austro-Daimler engine. By the end of the year, 72 aircraft of this type were completed and commissioned. Moreover, six *De Havilland* light bombers had their fuselage modified and were adapted for passenger transport with a view to their use on the airlines which were set up in this country in 1925.

Two prototypes of Romanian planes, the *Proto-I* and the *Aeron*, were built there in the following years.

With its limited production capacity, small workshops and insufficient and obsolete machine-tools, the *Arsenalul Aeronautic* was unable to meet the growing requirements of aviation, which was developing at a rapid pace. The need of creating a national aeronautical industry, foreseen by Vlaicu, became increasingly pressing, and one of the essential requirements for its creation was a sufficient number of well-trained technical aviation personnel.

The first Romanian aircraft engineers studied in France, where they graduated from the *Ecole supérieure d'aéronautique et construction mécanique*,





The assembly plant of the R.G.A. (Rezerva Generală a Aviației) workshop at Jassy, 1917.



The *Brandenburg* plane, built by the *Arsenalul Aeronautic* in 1922-1924.

the first specialized aviation school in the world. Among them were *Henri Coandă*, who graduated in 1910, *Stanislas Șeșefski* and *Constantin Gheorghiu*, who graduated in 1913, the latter being afterwards appointed technical director of the school attached to the workshops at Chitila, and second lieutenants *Ștefan Protopopescu* and *Gheorghe Negrescu*, who graduated in 1914. Afterwards several Romanian engineers graduated from specialized aviation schools in Italy, Germany and Britain.

In 1928 the foundations of higher technical aeronautical education in Romania were laid with the creation of a special chair as part of the Mechanics Faculty of the Bucharest Polytechnical School. In 1934 the chair became a Department.

The situation was different as regards the medium and inferior technical personnel of our aviation, there being both a shortage of effectives, and deficiencies of training due to the lack of suitable special schools. The first school for aviation craftsmen was set up in 1921 by the Air Force on the aerodrome of Pipera. In 1924 it was moved to Mediaș, where suitable housing and installations led to a reorganization as the *Școala tehnică a aeronauticii* (Air Force Technical School) with courses of different duration (six, seven and eight years). A part of the graduates of the School continued their studies, being commissioned as mechanics officers, some of them eventually taking aeronautical engineer degrees. Also in 1924, the Air Force preparatory and special schools were opened, among them a two-year Preparatory School for Mechanics Officers and a Reserve Officers Preparatory School for trainees who were civil aeronautical engineers.\*

With such skilled engineers and technicians, trained in our own schools and abroad, it became possible to set up a technical branch of the Air Force. As a matter of fact, such a department was actually set up with modest means on September 15, 1915, with the creation of the Air Corps, when aviation and balloon units, so far subordinated to the Corps of Engineers, became an independent arm.

The Air Force technical department, headed for a long time by Lieutenant-Colonel *Gheorghe Negrescu* (B. Sc., Aeron. Eng.) and Major *Constantin Mincu* (B. Sc., Aeron. Eng.), was a body of guidance and control and had a decisive role in the development of our aircraft industry.

The first Romanian aeroplane factory after the first world war was *Astra* of Arad; up to 1923 it had only manufactured rolling stock and in 1923 began to build the prototype of an aircraft conceived and designed by Engineer *Stanislas Șeșefski*. Next came the production of a series of *Proto-2* planes, deriving from the *Proto-1*, conceived by Major *Ștefan Protopopescu* (B. Sc., Aeron. Eng.) whose prototype had been made one year before by the *Arsenalul Aeronautic* of Bucharest. The group of senior specialists involved in aircraft building at *Astra* included aeronautical engineers *Radu Onciul*, *Victor Feodorov* and *Dumitru Barbieri*. In 1925, *Astra* made a prototype of the *Astra-Proto* reconnaissance plane, built after the design of Major *Ștefan Protopopescu*. This machine did not reach serial production. That year, airplane production at *Astra* came to an end because the plant and personnel were transferred to the new *I.A.R.* works at Brașov; the *Astra* factory at Arad continued to make railway rolling stock, but it also produced 250-HP Martha-Benz aircraft engines.

In 1920 an Air Force squadron of flying-boats was set up, but the obsolescence of its machines obliged it to stop flying in 1923-1924. It was in those circumstances that the *Societatea de transport Constanța — S.T.C.* (Transport Company of Constanța) took the initiative of building flying-boats. A single series of four such aircraft, the *S.T.C.-R.A.S.-1*, were built after the design of Engineer *Radu Stoika*. In 1927 *S.T.C.* stopped aircraft construction,

\* *Dare de seamă asupra activității școlilor pregătitoare și speciale ale aeronauticii, 1924-1928* (Report on the Activity of the Preparatory and Special Air Force Schools, 1924-1928), Bucharest, 1928, p. 19.



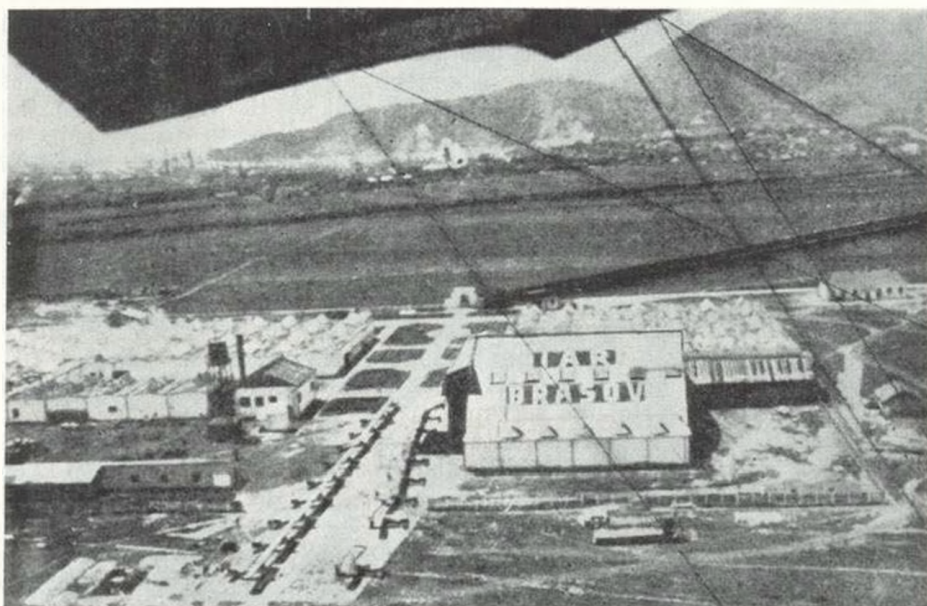

Aerial view of the *I.A.R.* Works, Braşov, in 1928.

having no support for a planned continuation and expansion of the production of flying-boats of Romanian models or built under licence.

The industrial manufacture of the first Romanian aircraft, in 1922-1925, signified a promising start for the development of a national aeronautical industry.

The year 1925 saw the laying of the foundations of a modern Romanian aircraft industry, which developed in the following years. On the eve of the outbreak of the second world war it included the *I.A.R.* works at Braşov, the *S.E.T.* and *I.C.A.R.* factories, the *A.S.A.M.* enterprise with branches in several towns, and a number of auxiliary units.\* Their achievements are epitomized in the following lines.



**The I. A. R. — Industria Aeronautică Română** (Romanian Aeronautical Industry) of Braşov was founded in 1925 as a joint-stock company, the initial capital being provided by a French group representing the *Blériot-Spad* and *Lorraine-Dietrich* works, the *Astra* factory of Arad, which contributed its specialized plant, and the Romanian State, whose participation consisted in cash and in the value of the land made available for the construction of the works and an airfield of its own.

\* *Realizările Ministerului aerului și marinei de la înființare și pînă azi* (Achievements of the Air Force and Navy Ministry from Its Inception to the Present Day), Bucharest, 1939, pp. 27-30.



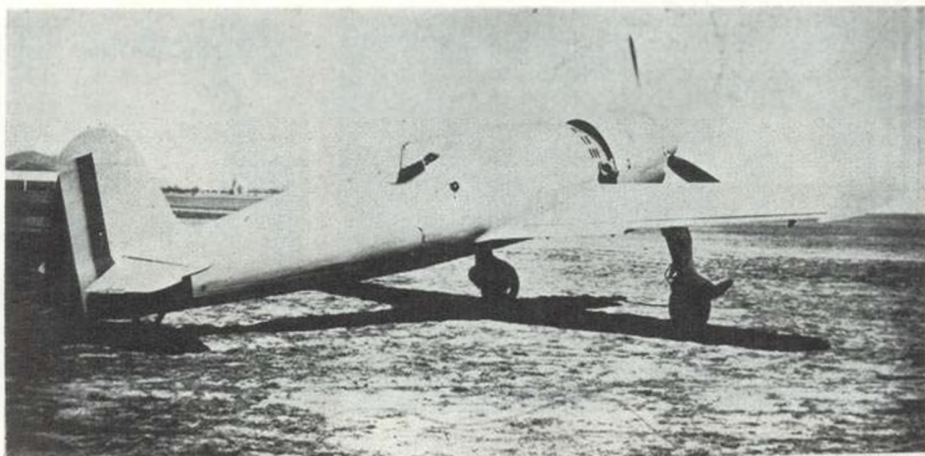

Prototype of the *I.A.R.-80*.

Gradually the shares held by the French companies were bought by the Romanian State, and on January 1, 1939, the *I.A.R.* works, reorganized as an autonomous state enterprise, became entirely Romanian-owned.

From its inception the *I.A.R.* works had a special organization, at the level of the then best developed aeronautical industries, comprising two distinct manufacturing units: a section for airframes and a section for engines. The *I.A.R.* works of Braşov built many types of Romanian designed planes and aircraft engines of all categories, and also made machines under licence: school and training craft, sports and touring and long-range airplanes, as well as military aircraft, including fighters and fighter-bombers, dive-bombers, observation and reconnaissance planes, and heavy (medium) bombers. The first order *I.A.R.* filled for the Air Force were 30 *Maurane-Saulnier M.S.-35* two-seater training craft, which were delivered by the autumn of 1928. These machines, as well as those supplied under the next order — 70 *Potez-XXV* reconnaissance and light bomber planes — were built under licences bought from the respective French factories.

The first aircraft called *I.A.R.* was completed in 1930. It was the prototype of a fighter, the *I.A.R.-C.V. 11*, built after the design of Engineer *Elie Carafoli* in collaboration with the French engineer *Virmoux*. Its formula was of a low-wing monoplane and its performance ranked it among the world's best aircraft of its kind.

Among the more than twenty types of planes built by *I.A.R.* of Braşov in nearly 18 years of activity, the following distinguished themselves by their performances: the *I.A.R.-16*, which, in 1935, set up a valuable national height record of 11,631 metres; the *I.A.R.-39*, used for many years as a reconnaissance plane; and the *I.A.R.-80* fighter, also built in the *I.A.R.-81* dive-bomber variant.

The *I.A.R.* works of Braşov also made the long-range reconnaissance *I.A.R.-47*, a low-wing monoplane with a crew of three. Of the three *I.A.R.-47* air-



Academician  
ELIE CARAFOLI.



ION STROESCU.

craft, one was used for static resistance tests of the airframe, the second did the flying tests to check performance, and the third remained unfinished. (The absence of the description of this plane from the second part of the present volume is due to the fact that the available reference material is insufficient.)

Beginning 1933, several young engineers strengthened the *I.A.R.* designing team. Of these, the late Professor Ion Grosu, and Ion Coşereanu and George Zotta were prominent contributors to such types as *I.A.R.-27*, *I.A.R.-39*, *I.A.R.-80*, *J.R.S.-79 B* and *I.A.R.-47*.

It should be noted that in the years 1927-1944 the aircraft output of the *I.A.R.* works of Braşov was among the most remarkable and representative activities of Romania's aeronautical industry.

In addition to building planes and engines, the *I.A.R.* works of Braşov also made certain equipments and accessories for the armament of military aircraft, such as:

— the *Barbieri* bomb release (named after its builder, *I.A.R.* Engineer Barbieri) manufactured in 1931 for the *Potez-XXV* plane; it was better than those bought from abroad;

— the *Grosu* machine-gun turret (named after its designer, *I.A.R.* Engineer Grosu) for the *Potez-XXV* and *Potez-54* aircraft.

The Braşov works also designed and built machine-gun turrets for the *I.A.R.-37* and machine-gun supporting arches for the *I.A.R.-38* and *I.A.R.-39* aircraft.

The aircraft engines manufactured by *I.A.R.* are presented in the following chapter.



**S.E.T.**— Societatea pentru exploatarea tehnice (Society for Technical Exploitation) was the second important unit of Romania's aircraft industry as to the volume and value of its output, after *I.A.R.* It was founded in 1923, when Engineer *Grigore Zamfirescu*, a graduate of the





Engineer  
RADU ONCIUL.



Engineer  
GRIGORE ZAMFIRESCU.



Captain  
CRISTEA CONSTANTINESCU  
(B. Sc., Eng.).

École supérieure d'aéronautique of Paris, obtained a concession for the mechanical workshops of a cooperative in Bucharest which he transformed into an enterprise. In 1924 a section for aeronautical constructions was set up. It began its activity with:

- the transformation of four *De Havilland*-type military aircraft into passenger planes for civil airlines;
- general repairs and overhauls of *Proto-2* planes built by *Astra* at Arad and used by the Military Flying School of Tecuci;
- the design for and construction of the prototype of a day reconnaissance and light bomber.

The design and construction of this first plane built by *S.E.T.* was the result of collaboration between engineers *Ștefan Protopopescu*, *Grigore Zamfirescu*, and *Dumitru Baziliu*, who was temporarily lent from the Higher Aeronautics Board. The memorandum listing the specifications of this plane was registered on November 28, 1924 under no. 11,055 by the Inventions Office of the Ministry of Industry and Trade. Although it proved to be capable of flying performances comparable to those of the foreign aircraft in service with our Air Force, the *Proto-S.E.T.* was not mass-produced. Next came the construction of the *S.E.T.-3* planes. Completed in 1929, the aircraft were assigned to the Military Flying School of Tecuci. The performances of the *S.E.T.-3* were very impressive, for which reason the Ministry of War placed an order for another 50 machines. As a result, the aeronautical constructions section recorded a notable development, and in 1931 the entire enterprise was reorganized, becoming the *S.E.T.* aircraft factory.

The *S.E.T.* aircraft factory built Romanian-designed planes and also machines under licence. The best Romanian planes made by the factory were the *S.E.T.-3*, *S.E.T.-31*, *S.E.T.-7 KD*, *S.E.T.-41* and *S.E.T.-31 G*.

The *S.E.T.-X* fighter trainer and the *S.E.T.-XV* fighter biplane prototypes did not reach the serial-production stage. The *S.E.T.-41 R* long-range plane,



powered by a 240 HP Gnôme-Rhône engine, and the *S.E.T.-4 S* training plane with a 300-HP Hispano-Suiza engine, also remained in the prototype phase. The machines built under licence were a modified prototype of the French fighter aircraft *Spad*, 80 *Fleet F. 10 G*, and 124 *Nardi F.N.-305* planes. The last project of the *S.E.T.* factory was the *S.E.T.-20* twin-engined monoplane, which did not get beyond the laboratory test stage. In view of the development level reached by the *S.E.T.* factory, the State ordered from it 80 *I.A.R.-27* and 96 *I.A.R.-39* machines. In 1946, *S.E.T.* built under licence 40 Grünau Baby II-B gliders, with structural changes made by Engineer *Alexandru Marcu*.

For certain types of aircraft supplied to the Air Force, the *S.E.T.* factory also designed and made various armament accessories, for instance the *S.E.T.* machine-gun turret for the *S.E.T.-7K* and *S.E.T.-7KD*.

Following a convention with the Air Force and Navy Ministry, which guaranteed orders for a period of five years, in 1938 the *S.E.T.* factory was to move to Tirgu Ocna and a modern aeronautical industry (planes and engines) was to be created there under the name *S.E.T.-I.N.A.*, that is, *S.E.T.-Industria Națională Aeronautică* (National Aeronautical Industry). The outbreak of the second world war prevented the carrying out of this plan.



**I. C. A. R.-Întreprinderea de construcții aeronautice românești** (Enterprise for Romanian Aeronautical Constructions) was set up in 1932 at the initiative and under the management of Engineer *Mihail Racoviță*. The production of this enterprise was oriented almost exclusively to the building of light planes, and later also of gliders for civil aviation.

The noteworthy machines manufactured by this enterprise included the *I.C.A.R.-Universal* aerobatic single-seater, the *I.C.A.R.-Universal* school, training and club two-seater, with which a successful long-distance group flight was carried out in 1935 over the Bucharest-Capetown-Bucharest route, and the *I.C.A.R.-Comercial* transport plane, which was used for passenger services in Romania in the years 1936-1938.

The glider department, headed by Engineer *Nicolae Racoviță*, mass-produced the primary training glider *I.C.A.R.-1* and the Grünau Baby II B gliders. Engineers *D. Bulgaru* and *V. Timošencu* were among the men who contributed to the development of the enterprise.

In 1938, the Ministry of the Air Force and Navy concluded a convention with the *I.C.A.R.* factory guaranteeing it a bigger volume of orders with a view to developing its production. It was envisaged to move it to Transylvania, where it was to receive new buildings and modern equipment, and its name was to be changed into *Uzinele I.C.A.R. — Societate Anonimă* (I.C.A.R. Works, Limited Company). As in the case of the *S.E.T.-I.N.A.* enterprise, the plan for the development of the *I.C.A.R.* factory was not carried out, and for the same reason.

Among the auxiliary enterprises which assisted the above-mentioned principal companies in their production were the *S.E.M.A.T.* and the *Forja Poldi-I.A.R.* factories.

The *Societatea pentru exploatarea de materiale aeronautice și tehnice* — *S.E.M.A.T.* (Society for the Exploitation of Aeronautical and Technical Material) was set up in 1934 under the management of Air Force Reserve Lieutenant *Ion Simionescu*. The workshops of *S.E.M.A.T.* mass produced retractable under-carriages of various types under licences from the well-known specialized French factory *Messier*. The under-carriages were supplied to the *I.A.R.* works for the *I.A.R.-80* and the *J.R.S.-Savoia Marchetti-79 B* planes. *S.E.M.A.T.* also manufactured synchronizing devices for firing through the rotation field of the airscrew, and other accessories.

The *Forja Poldi-I.A.R.* forge was built in Brașov in 1937 with the financial and technical assistance of the Czechoslovak *Poldi-Hütte* steel works. The forge produced raw wrought pieces, all of which had been bought up to then abroad, meeting a considerable proportion of the steel requirements of our aeronautical industry.

It should be noted that several non-specialized enterprises also supplied certain parts and material to our aeronautical industry. Among those enterprises were the *Industria silvică* (Forestry Industry) of Maramureș, the main supplier of veneer, the *Jaquard* company of Sighișoara, which manufactured aeroplane fabric and parachute silk, the *Industria de fabricație metale feroase I.F.M.F.* (Ferrous Metal Products Industry) of Bucharest, which made, mainly for the *I.C.A.R.* factory, welded aluminium tanks, cowlings and fairings, stainless steel exhaust headers a.o.

During its first period, the Romanian aeronautical industry was able to cover only 12 per cent of its raw material and semi-finished products requirements for compound (timber and metal) planes and only six per cent for its all-metal aircraft from Romanian sources. Aluminium, duraluminium, special steels, pannellings, castor oil, aircraft fabric, lacquers and dyes, wrought and machined parts etc. were imported, especially from France. Gradually these materials, with the exception of aluminium, brass and special steels, began to be supplied by Romanian enterprises. By 1939 the proportion of Romanian materials used by our aeronautical industry reached about 50 per cent.\*

The year 1939 saw a maximum effort for the development of our aeronautical industry. After a period of stagnation, the Aeronautical Arsenal of Bucharest, which had manufactured the first mass-produced aircraft, entered a new development and purpose after June 1, 1939, as a result of the establishment of an important enterprise called *A.S.A.M.*

*Administrația stabilimentelor aeronauticii și marinei A. S. A. M.* (Administration of Air Force and Navy Establishments) included the Aeronautical Arsenal of Cotroceni (Bucharest) as the central unit and overhaul and repair workshops of the Air Force at Pipera (Bucharest), Mediaș, Galați, Tecuci, and Jassy, as well as the Naval Arsenal of Galați.

\* *Realizările Ministerului aerului și marinei de la înființare și pînă azi*, Bucharest, 1939, p.28.





Engineer  
RADU MANICATIDE.



Engineer  
IOSIF ȘILIMON.



VLADIMIR NOVITCHI.

The aim of the creation of this new autonomous state-owned enterprise, which was the biggest after *I.A.R.* from the industrial viewpoint, was to secure aircraft repairs and to manufacture spare parts for planes and engines in service.

During this period, in addition to the very good Romanian-designed planes, Romania also manufactured a number of aircraft under licence. The latter included machines which had won recognition all over the world as being types representing famous manufacturers in countries having a solid tradition in aviation, such as France, Germany, Italy, Poland, USA a.o. As mentioned before, the first foreign planes made in this country were machines of the *Farman* type built in the workshops of the flying school of Chitila and then in the workshops of the flying school of Cotroceni, *Brandenburg* aircraft manufactured at the Aeronautical Arsenal, and *Morane-Saulnier M.S.-35* and *Potez-XXV* planes, with which the *I.A.R.* works of Brașov started its production.

Although some of the planes produced under licence, for instance the *Fleet F. 10 G*, *P.Z.L.-11*, *P.Z.L.-24* and the *Messerschmitt Me-109* were reproductions of the respective originals, in the case of the first three the engines were replaced by engines made in this country; as to the *Savoia Marchetti S-79 B* twin-engined aircraft, it was built in a new variant based on studies and computations made by the team of the *I.A.R.* works. The new variant, *J.R.S.-79 B* had a modified airframe (including the tail piece), which distinguished it from the original plane. In the case of the *Fleet F-10 G* only the engine was replaced, but the change was visible in the profile of the aircraft because the original 115 HP *Kinner* radial engine made way for the in-line *I.A.R. Gipsy Major-4*.

The above-mentioned planes were mass produced by *I.A.R.* of Brașov. *S.E.T.* built under licence the *Spad* fighter (whose frame was modified, resulting in the improvement of its flight performances), the school and training plane *Nardi F.N.-305*, and 80 aircraft of the *Fleet F-10 G* type.





Master of Sports  
OVIDIU POPA.



Engineer  
TRAIAN COSTĂCHESCU.

The *I.C.A.R.* factory manufactured the well-known *Fieseler Fi-156 Storch* liaison, observation and command plane.

In connection with foreign-designed aircraft built or transformed in this country, it should also be noted that in 1956 the *Centrul tehnico-industrial aeronautic Pipera* (Aeronautical Technical and Industrial Centre of Pipera) transformed the *Yak-23* jet single-seater fighter into a dual-control aircraft for the training of military pilots.

After the end of the second world war, the *I.A.R.* factory of Braşov was transformed into the *Tractorul* works, which manufactures tractors, but an aircraft and glider and experimental workshop, headed by Engineer *Radu Manicatide*, continued to function there. In 1949 this unit resumed the production of planes with the manufacture of the *I.A.R.-811*.



In 1951, Romania had the following aeronautical construction units: *Atelierele de reparații material volant A.R.M.V.-1* (Aircraft Repair Workshops) at Mediaş, the *A.R.M.V.-2* on the aerodrome of Pipera (Bucharest), and the *Uzinele de reparații material volant U.R.M.V.-3* (Aircraft Repair Works) of Braşov. Later on, a workshop for the repair of airframes was added to the *U.R.M.V.-3*. Headed by Engineer *Iosif Şilimon*, the shop also began to build *I.S.* gliders.



Another industrial unit building planes was the *Întreprinderea forestieră pentru industrializarea lemnului I.F.I.L.* (Forestry Enterprise for Timber Processing) of Reghin, later renamed *Combinatul pentru industrializarea lemnului C.I.L.* (Timber Processing Combine), where a section for the construction of gliders and light aeroplanes was set up in 1950 under the management of *Vladimir Novîţchi*.



The *A.R.M.V.-2*, temporarily known as the *C.T.I.A. Centrul tehnic industrial aeronautic* (Aeronautical Technical and Industrial Centre) and after 1959 as the *I.C.R.M.A. Întreprinderea de construcții și reparații material aeronautic* (Aeronautical Material Construction and Repair Enterprise) was renamed *I.R.M.A.*

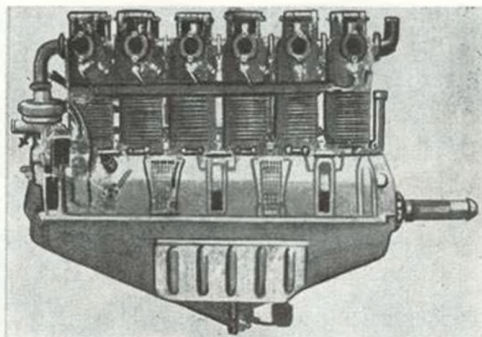
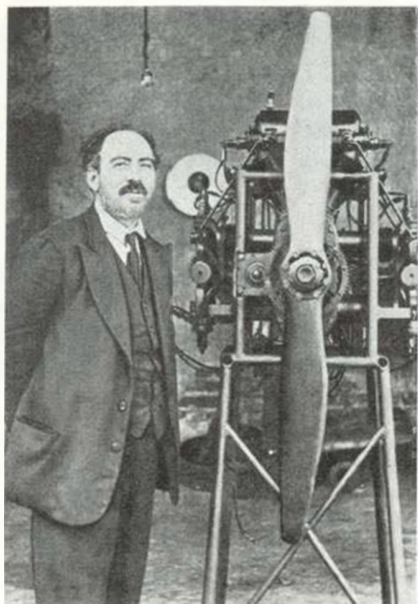

The Martha-Benz engine built by Astra of Arad.

Nicolae Popescu-Cimpina with his engine on the test stand.



*Intreprinderea de reparat material aeronautic* (Aeronautical Material Repair Enterprise). In 1960 the glider construction section of *U.R.M.V.-3*, headed by Engineer Iosif Șilimon, was taken over by the local industry enterprise of Ghimbav. This section developed and became the **I.C.A. — Aeronautical Construction**

Enterprise of Brașov which, inter alia, manufactured the first Romanian all-metal gliders. The U.R.A. aircraft repair works of Bacău was set up for the general repair of aircraft bodies and engines of all categories.

## ENGINES

One of the first Romanians to build aircraft engines was *Nicolae Popescu-Cimpina*. Enamoured of aviation, he joined the workshops of Cotroceni in 1916 and after Romania's entry into the war was transferred to Jassy together with the shops which had become the *Rezerva generală a aviației* (General Air Force Reserve). It was during this period that Nicolae Popescu began to work on an original engine, for whose perfection he laboured more than a quarter of a century.

The first aircraft engine built in this country and powering an aeroplane was a six-cylinder in-line engine built by Astra of Arad after a Martha-Benz model for the *Astra-Șeșefski* plane. The first mass-produced engines included the radial rotary nine-cylinder Gnôme-Rhône and the 450-HP 12-cylinder V



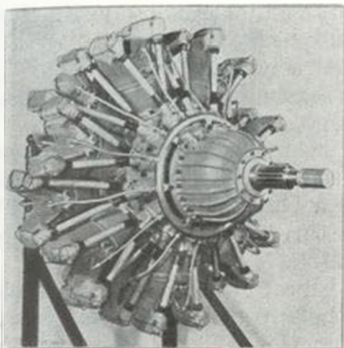

The I.A.R.-K. 14 - 1000 A engine.

Drawing of a rocket in the manuscript of Conrad Haas.

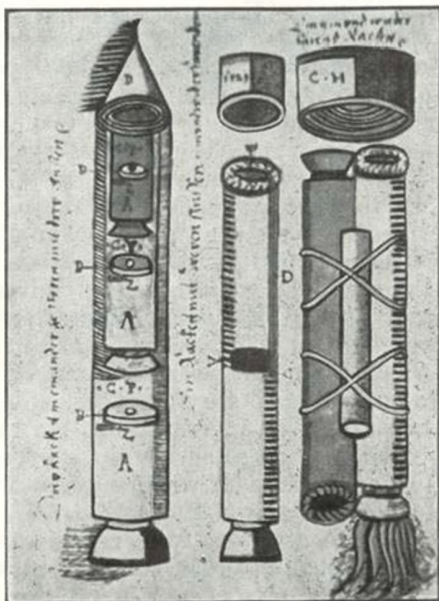

air-cooled Lorraine-Dietrich. They were manufactured by the *I.A.R.* works of Braşov for the *Morane-Saulnier MS-35* and the *Potez-XXV* planes in 1928. *I.A.R.* of Braşov also built, under licence, the D.H. 130-HP Gipsy Major-4 for the *Fleet F-10 G*, *I.A.R.-22* and *I.C.A.R.-Universal* planes, and the 190-HP Gipsy Six, known as the *I.A.R.-6 G1*, for the *I.A.R.-27* and *Nardi F.N.-305* aircraft.

In 1936, the *I.A.R.* works mass-produced the first Romanian-designed aircraft engine, the nine-cylinder radial *I.A.R.-K 9*. Its rated power at an altitude of 4,000 m was of 640 HP, with a total cylinder capacity of 24.86 litres, and a weight of 437.5 kg. The *I.A.R.-K 9*, powering the *P.Z.L.-11 F* plane, was better than the French Gnôme-Rhône on which it was modelled. Only 68 of its 648 items were identical with those of the French engine, and 580 (some 90 per cent) were totally different as to design, raw material, treatment, processing and size.\* The engine was the result of the endeavours of the team of engineers and technicians of the *I.A.R.* works.

Two other engines made by *I.A.R.* for mass-produced planes were the *I.A.R.-K 7*, powering the *S.E.T.-7 B* and *S.E.T.-7 KD* and the *I.A.R.-K 14* for the *P.Z.L.-24*, *I.A.R.-37* and *I.A.R.-39* aircraft.

The last engine built at Braşov, known as the *I.A.R.-1000A*, was an improved variant of the *I.A.R.-K 14* and powered the *I.A.R.-80* and *I.A.R.-81* fighters.

\* Ing. Gheorghe Popescu-Botoşani, *Primul motor de aviație românesc* (The First Romanian Aviation Engine), Bucharest, 1936, pp. 3-6.



This supercharged engine had an intake pressure of 1,000-1,100 mm Hg; its take-off power was of 960 HP at 2,300 rpm and it reached 1,000 HP at the optimum altitude. The *I.A.R.-1000A* weighed some 720 kg.

Speaking of engines, it is worth mentioning the first reactive propulsion experiments made in this country nearly 450 years ago.

A number of documents bearing this out have been found in the archives of Sibiu. They are studies and designs of the rockets tested in that town by *Conrad Haas* and *Johann der Walache* (John the Romanian). In 1529 Haas designed a two-stage rocket and in 1536 a three-stage rocket. In 1555 he designed, built and tested a four-stage rocket.\*

Among the very rare volumes of the University Library of Cluj is a unique specimen of a valuable Transylvanian treatise, the *Breviculus Pyrotechnicus*, probably written in 1676 and published in Cluj in 1697, whose author, who apparently was familiar with the subject, wrote about rockets.

A man to be remembered in the history of aerospace science is *Herman Oberth*, born in Sibiu in 1894. In 1929, when the University of Cluj awarded him the title of professor, he published his now famous *Wege zur Raumschiffahrt* (Paths to Cosmic Travel) which he had written during his stay in Mediaş and which won a prize of the Astronautics Society of France. In that work Oberth expounded general theoretical considerations on space travel and described several designs for two- and three-stage rockets. Herman Oberth also made studies on rocket fuels. His invention, *Rapid Combustion Procedure and Device*, was patented under No. 15,516 in March 1931.\*\*

In an article printed in the Bucharest magazine *Natura* (no. 10 for December 15, 1932), entitled *Zborul rachetelor și zborul în vid* (The Flight of Rockets and Flight in Empty Space), Oberth formulated a number of principles that are still relevant to the construction and flight of space rockets.

Acknowledged as a pioneer in this field, Herman Oberth was one of the guests of honour of the Kennedy Space Centre at the launching of the *Saturn V* rocket and the *Apollo XI* space ship that carried the first man to step on the Moon.

## AIRCRAFT EQUIPMENT AND APPARATUS

The start of aircraft equipment manufacture in Romania was very difficult because it demanded complex tools of high precision, well-trained, specialized technicians and special materials, none of which were available

\* One of the papers of the Romanian delegation at the International Astronautics Congress held in Madrid between October 9 and 15, 1966, and attended by 1,000 experts from 33 countries, dealt with the construction and testing of these rockets. A mock-up of the three-stage rocket was on show at the exhibition The Development of Science in Romania, organized in Bucharest in 1966 to mark the centenary of the Academy of the Socialist Republic of Romania.

\*\* Ing. Ion Iacovachi, *Figuri de seamă de inventatori români. II. Oberth - Creator al astronauticii* (Outstanding Romanian Inventors. II. Oberth, One of the Creators of Astronautics) in *Revista Transporturilor*, no. 5, May 1957, pp. 204-207.

in this country at that time. All aircraft equipment and apparatus for Romanian-designed machines and for aircraft built in Romania under licence had to be imported. As Romania's aeronautical industry developed, the local manufacture of aircraft equipment and apparatus became a topical problem.

The first Romanian company producing aircraft equipment was *Prerom*. It was set up in 1936 at Braşov with the assistance of the Czechoslovak companies *Prerna* and *Kadlec* whose aircraft equipment was built under licence.

Within a brief space of time *Prerom* succeeded in manufacturing the whole range of aircraft equipment required for the planes built by Romania's aeronautical industry. Under the technical management of Air Force Captain *Gheorghe Botez*, the personnel of the factory innovated on the licences it had acquired and also built equipment of its own design.

The contribution of the *Prerom* company can be judged by the fact that most of the aircraft equipment used by the *I.A.R.-80* fighter planes carried the trade mark of the factory. These included the water thermometer, the oil thermometer, the fuel pressure gauge, the oil pressure gauge, the litrometer, the centrifugal counter (tachometer), the admission pressure gauge for the gas compressor, the speedometer, the turn and bank indicator, the altimeter, the *LK-20* compass, the *LK-14* compass, and the variometer. In the field of aircraft radio and photo equipment, Romania has a good tradition.

In 1912, Air Force Second Lieutenant Ştefan Protopopescu flew a *Farman* plane on which a wireless apparatus, adapted by Captain *Zaharia* and technician *Gustav Rotlender* of the Romanian Maritime Service, was successfully tried out. In connection with those tests the *Gazeta ilustrată*, no. 34 of 1912, reported:

"A problem which has not yet been solved abroad has been resolved in this country with Romanian-made apparatus thanks to the endeavours of Captain *Zaharia* and technician *Gustav Rotlender* of the Romanian Maritime Service. We refer to the utilization of Marconi's great invention, wireless transmission, with the help of aeroplanes. The recent experiments at Constanţa have been entirely successful."

However, the success of the tests had no practical results because at that time Romania had no radio industry. A similar fate befell other inventions related to aviation radiotelegraphy, for instance the aircraft and ground equipment for blind landing conceived in 1936-1938 by Captain *Traian Zaharescu* (B.Sc.Eng.), a graduate of the High School of Electricity of Paris. His set of installations was more economical and, in some respects, better than those made abroad.

The first aerial photographs were taken with the assistance of kites and balloons. The first Romanian who made aerial photographs was *Aurel Vlaicu*. In 1907, when doing his military term in the Austro-Hungarian Navy, *Vlaicu* photographed the ships laying at anchor in the Adriatic port of Pola with a camera attached to a kite designed and built by himself.

The first photographs taken from an airplane were made in Romania in 1911 during reconnaissance flights carried out by Romanian flyers in the





The first aerial photo-camera workshop of Cotroceni (1916).

course of military manoeuvres held near the town of Roman.\* Experiments with aerial photography from aircraft were resumed by Romania's Air Force in 1914.

The first Romanian aerial cameras (9×12 cm) were built at the beginning of 1916. A special workshop was organized for the purpose at the initiative and under the guidance of Reserve Second Lieutenant *Gheorghe Ionescu* at the Cotroceni Flying School. After Romania entered the first world war, the photo cameras made by that workshop were supplied to the six photo sections of the six Air Force squadrons at the front, which obtained good pictures of enemy objectives from the first days of the campaign. In the autumn of 1916, a French military mission arrived on the front and after that the Romanian Air Force received better aerial cameras. They and other cameras bought in the following years abroad were used up to the year 1935, when the first mass-produced Romanian aerial cameras began to be manufactured by the specialized Romanian *A.C.T.A.* and *T.A.R.* companies.

*Atelierele de construcții tehnice și aeronautice, A.C.T.A.* (Workshops for Technical and Aeronautical Constructions) mass produced aircraft cameras,

\* *Istoricul aviației militare până la sfârșitul marelui război* (The History of the Air Force up to the End of the Great War) in the booklet *Prima expoziție de aviație din România* (The First Aviation Exhibition in Romania), Bucharest, 1927, p. 41.



Semi-automatic aerial photo-camera of the *D.I.D.* type, 1938 model.

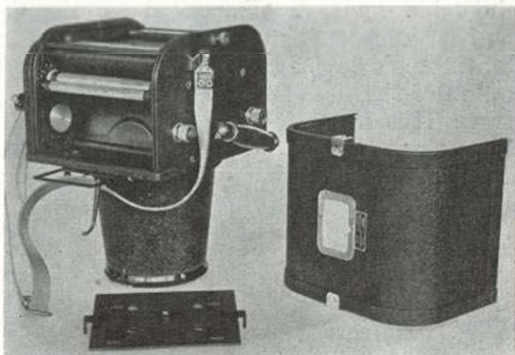

photo and film machine-guns for flying personnel training in air gunnery optical sights for the determination of aircraft drift and speed (cinemoderivometers) etc. The aircraft cameras supplied to the Air Force were built after the designs of *Dimitrie I. Dimitriu*, who was the technical manager of *A.C.T.A.* up to 1939. He had built such cameras in rudimentary workshops since 1931. The cameras made by *A.C.T.A.* were named *D.I.D.* They included the  $13 \times 18$  cm 1938 model of the *D.I.D.* semi-automatic hand operated aircraft camera, with a focal distance of 25 cm and using a 100-picture film, and the  $18 \times 24$  cm 1939 model of the *D.I.D.* automatic aircraft camera with a focal distance of 30 cm and 50 cm (Patent No. 29,707/1939 issued by the Ministry of Industry and Trade). These cameras were as good as the best foreign-made aerial cameras. The 1939 model was used up to 1960. Its valuable structural innovations included the following:

- *the optical sight*, correcting the drift effect, introducing the aircraft's speed value and transmitting stand-by time to the intervalmeter;
- *the intervalmeter*, carrying the film automatically and starting the shutter according to the stand-by time given from the optical sight through a Bowden cable;
- *the recording box*, printing on the film the actual time (hour and minutes), the flying altitude and the frame number.

In 1939 *Dimitrie I. Dimitriu* organized a new company for the manufacture of aerial cameras, *Tehnică aeronautică română, T.A.R.* (Romanian Aeronautical Technique), which also built the *T.A.R.*-type *D.C.* aircraft photo machine-gun, named after the designers *Dimitrie Dimitriu* and *Andrei Cujbă*; it was used in the training of fighter pilots.

Air Force Captain *Andrei Cujbă* also made another valuable invention, the *giro-pendular optical sight* for dive bombing, whose prototype was mounted and tested on an *I.A.R.-80*.

Speaking of aerial gunnery devices, it is worth recalling that one of the first systems of firing through the airscrew was invented by the Romanian engineer *George (Gogu) Constantinescu*, the world-famous scientist who discovered sonicity. Like other Romanian inventors of those days, he did not find the necessary support for his research at home. He left for Britain,

where his device was mounted for the first time on the *S.E.-5 A*, one of the best-known fighter planes of the first world war. Engineer Gogu Constantinescu's device was based on the application of sonicity to the synchronization of the fire of the aircraft's machine-guns with the rotation of the air-screw. This made it possible to place the machine-guns under the hood of the engine. Up to that time, the fixed machine-guns of fighter planes were placed over the upper wing, which influenced the firing precision in a negative manner.

## LIFE-SAVING EQUIPMENT

The principal life-saving equipment of an aircraft's crew is the parachute, but parachutes are also used for the launching of parachute troops and aerial sports competitions.

In Romania parachutes were mainly used during the first world war by the crews of captive observation balloons. They were practically never taken up by aircraft pilots, nor were they compulsory at that time anywhere in the world. The first Romanian parachute was made in the workshops of the Balloon Group, Romanian Air Force, at Pantelimon, in 1922, after a French model. The launching tests made at the Air Force training centre of Tecuci, using ballast, were successful, but they were discontinued.\*

One of the first Romanian-designed parachutes was made by *Eugen Szi clay*, who jumped at a height of 1,000 m from a three-engined *Caudron* at the aerial rally on the airport of Băneasa on July 20, 1925.\*\*

That year, foreman *V. Popa* of the Balloon Group, Romanian Air Force, made a parachute whose form was almost semi-spherical. Launched with a ballast charge from a balloon on September 3, 1925, the parachute gave full satisfaction.\*\*\*

In 1927 *Gheorghe Popoiu* designed and made a parachute which was launched with a ballast charge from a plane. Although satisfactory, it was not mass produced.

The first mass-produced parachutes were made in Romania in 1934, when a factory of the *Irvin* company was opened in Bucharest. The unit produced *Irvin-type* parachutes and flying suits.

The first Romanian-designed parachute to be mass produced was made by Captain *Ștefan Șovert* (B.Sc., Eng.). Patented in 1943 (Patent No. 34,249), it began to be made in 1951, being used in Romania for over 22 years without any jumping accident.

Military jet and high-speed experimental aircraft are now using jettisonable parachute chairs, or parachute equipped cabins, the jettisoning being started

\* *Despre parașute* (Parachutes), in the review *Aripa*, no. 9 of May 10, 1925.

\*\* *Aeronautica la noi* (Aeronautics in Romania), in the review *Aripa*, no. 20 of July 26, 1925.

\*\*\* *O parașută nouă — invenție românească* (A New Parachute Invented in Romania), in the review *Aripa*, no. 27. of October 11, 1925.

The launching from a plane and landing of the parachute-cell made by Anastasie Dragomir (from the paper *Excelsior*, Paris, August 29, 1929).

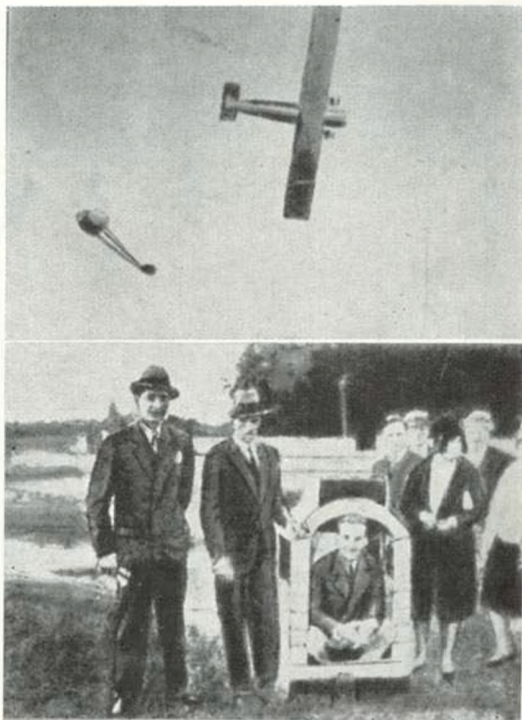

through a mechanical or pyrotechnic system. A similar system was designed more than 40 years ago by the Romanian *Anastasie Dragomir*, who patented and tested it in France (French patent No. 675,566/1930).

This life-saving system had the form of a set including the seat of the passenger and the parachute. The inventor called it *parachute-cell*. It was independent and could be released by the pilot through a trap door in the floor of the aircraft. Dragomir's invention was first built as a mock-up. On August 28, 1929, it was tested on the airfield of Buc, near Orly. The parachute-cell was launched from a *Farman* plane flown by the famous French pilot Bussoutrot.

The system foreseen by Anastasie Dragomir is now currently used by military aircraft.\* After returning to Romania, Anastasie Dragomir obtained several Romanian patents linked to essential improvements made to his important invention.

\* Ing. I. Iacovachi: *Inventatorul român Anastasie Dragomir — precursorul cabinei catapultabile* (The Romanian Inventor Anastasie Dragomir, a Pioneer of the Jettisonable Cabin), in *Revista transporturilor*, no. 11, 1969, pp. 509-511.



## AERONAUTICAL LABORATORIES

At the time of the birth of aeronautics, the theoretician, designer, constructor, mechanic, and pilot were one and the same person. It was he who conceived and constructed the plane, and took it up into the air, risking his life at any moment in the process. Later on, when aviation began to develop impetuously, the manufacture of an aeroplane became a complex activity, each of its successive phases requiring the contribution of a great number of specialists and the utilization of increasingly complicated plants. Every problem had to be studied and solved on a rigorously scientific and experimental basis.

A highly important role had to be assumed in this context by the aeronautical laboratories, which started to examine, analyse and test all elements linked to the building of new types of aircraft, from the construction materials down to the behaviour of the machines in various conditions on the ground and in the air.

Immediately after the first world war, the growing demand for high-quality material for the manufacture of better aircraft made it necessary to set up physico-chemical research and mechanical testing laboratories in Romania. The beginning was modest. An installation was devised for the production of "emaillite" (a lacquer for the fabric covering the plane) which had been imported from abroad. The plant was part of the Aeronautical Arsenal of Bucharest and operated under the control of chemical expert *Gheorghe Ionescu*, who had found a formula of his own for the production of emaillite.

The year 1924 marked the beginning of the construction of the *Laboratorul central de cercetări fizico-chimice și încercări mecanice al aeronauticii* (Air Force Central Laboratory for Physico-Chemical Research and Mechanical Testing). In 1925 Captain *Ion Gudju* (Dr. Eng.) was appointed chief of this laboratory which had three sections (mechanical tests, physico-chemical analysis, and electricity) equipped with the most modern installations in this country.

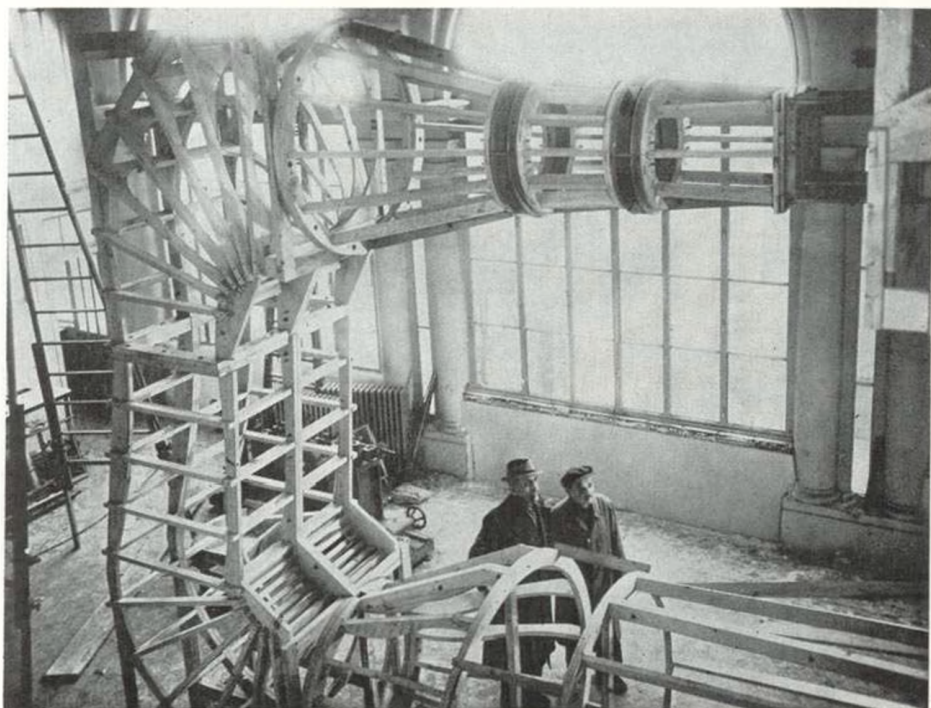

The wind tunnel of Bellevue (France) designed by Ion Stroescu, during its construction.

The Air Force Central Laboratory for Physico-Chemical Research and Mechanical Testing carried out the first examinations and tests on the materials used for the construction of planes and engines, studies and experiments that made it possible to replace imported plywood by Romanian plywood, to manufacture in this country special fabrics (for planes, balloons and parachutes) which had been imported, to improve aircraft fuel \* and oil etc. After 1930 the Air Force Central Laboratory continued to make an effective contribution to the progress of Romania's aeronautical industry under the management of Captain *Romulus Oanceanu* (B.Sc., Chem. Eng.), and then of Captain *Dumitru Săndulescu*, Doctor of Chemistry.

One of the important stages in the building of a new type of plane is the testing of the prototype, first in the form of a model in an *aerodynamic tunnel* and then at life-size, so as to study the results of the dynamic action of the air streams on the aircraft in various positions and specific flying conditions.

\* It was during that period that Captain Ion Gujdu (Dr. Eng.) and Pascal Popescu (Dr. Eng.) wrote the paper *Contribuții la studiul benzinelor motoarelor de avion. Cercetări asupra noilor criterii: antidetonajia și tensiunea vaporilor* (Contribution to the Study of Aircraft Engine Fuels. Research on the New Criteria of Antidetonation and Vapour Tension). The paper won a prize of the Romanian Academy.



A remarkable contribution to this domain was the construction of original installations in this country, many years before modern aerodynamic laboratories of the present kind were built. For instance, as far back as in 1908, *Ion Paulat* experimented with a small wind tunnel he had invented and built. One of the first Romanian specialists in aerodynamics was *Ion Stroescu*. As part of his mansided activities in this field, Ion Stroescu, who devised some original methods of lift-augmentation,\* especially concerned himself with the problem of wind tunnels.

In 1925-1929 Ion Stroescu built, at his own expense, the first wind tunnel in Romania,\*\* and in 1930 he helped to construct the wind tunnel at the Bucharest Polytechnic. In 1946, the model of an original tunnel, made by Ion Stroescu and presented at the International Applied Mechanics Congress of Paris, became the starting point for the building of a special aerodynamic tunnel\*\*\* for the study of the icing phenomenon\*\*\*\* in France.\*\*\*\*

This prodigious work in aerodynamics earned high appreciation for Ion Stroescu at home and abroad.

An outstanding contribution to the progress of Romanian aeronautical research has been made by the aerodynamics laboratory of the Bucharest Polytechnic. The laboratory belonged to the Aviation chair, headed since its establishment by Academician *Elie Carafoli*. Since 1930 the laboratory had a wind tunnel, the first installation of its kind in South-East Europe. Most of the aircraft built in this country were studied and tested in scale model form in that wind tunnel up to 1950. Academician Carafoli is well known in world aviation, and his name is linked to many achievements in research and technology. The Romanian scientist is mentioned in specialized world literature in connection with the *Carafoli profiles*, the *Toussaint-Carafoli vat*, his research on the wing theory, a.o. The Romanian school of aerodynamics created and led by Elie Carafoli has carried forward the traditions of the Romanian aviation pioneers and performed an excellent activity that is acknowledged throughout the world. For his outstanding merits in the development of aeronautical science, Academician Elie Carafoli has been awarded numerous distinctions, among them the *Louis Bréguet* prize (Paris, 1928, and 1967) and the *Karl Friedrich Gauss* medal (Braunschweig, 1970), and in 1968 he was elected President of the International Astronautical Federation.

In 1950-1956 a subsonic tunnel was designed and built by a team headed by Academician Elie Carafoli and Prof. Ion Stroescu at the Institute of Applied Mechanics of the Romanian Academy. It is a closed circuit tunnel type, with a single return channel; its experimental zone has the form of an octagon, size: 2.5×2 m. The installed power is of 300 kw, which makes it possible to obtain a speed of 60 m/s in the experimental chamber, but

\* Two of these methods of lift-augmentation (one using aspiration, and the other the acceleration of the boundary layer) conceived in 1911, are now applied at supersonic aircraft

\*\* The tunnel had an opening of 1.50 m and a *Stroescu*-type measuring device

\*\*\* The tunnel was built under contract by the Aerodynamics Institute of Romania for the French National Office of Aeronautical Studies and Research (ONERA)

\*\*\*\* 1. Stroescu, *Réalisation d'une maquette de soufflerie de girage aux laboratoires de Bellevue*, in *Journal des Recherches*, no. 4-5, Paris, 1946.





Static test of a *Proto-2* plane, made in 1925 at the *Astra* factory of Arad.

the circuit was so designed as to permit an increase in the installed power of up to 1,000 kw and a speed of 100 m/s.

The aerodynamic circuit is notable for the high contraction factor of the header, which secures a good flow in the experimental zone and a degree of turbulence below 1%. In this device scale models of planes manufactured by Romania's aviation industry after 1955 were tested as well as other types of land and air vehicles, and big industrial constructions. Studies were carried out on the aerodynamic load of certain high civil constructions, the wind resistance of cooling towers at thermopower stations, as well as ventilation problems in the turbine halls of industrial centres. As to fundamental research, studies were carried out on lift-augmentation by the lateral fluid jets system of small aspect ratio wings and on the vision of streamline flows.

Following an international convention concluded in 1919, the recommendation was made that before testing planes in the air their prototypes should be submitted to pre-flight examinations on the ground and that such examinations should include structural and components testing. This recommendation was usually ignored because it implied the loss of one of the prototypes, which cost a great deal. However, in 1924, the alarming increase in the number of break-ups of aeroplanes in the air led to static tests being made compulsory under the control of state aviation authorities.

In Romania the first static tests were made in 1925 at the Aeronautical Arsenal. They were initiated and supervised by Captain *Constantin Mincu*

(B. Sc., Aeron. Eng.). Two *Spad-VII* machines, which had been in service for some time, were subjected to tests to see whether they could still be used for flying. Also in 1925, a *Proto-2*, mass-produced by the *Astra* factory of Arad, was subjected to static tests. Although the prototype, *Proto-1*, built at the Aeronautical Arsenal of Bucharest, had flown perfectly and carried out the whole range of acrobatic figures, the first machine of the series manufactured at Arad broke up in the air during its test flight with Lieutenant *Ion Sava*. This led to the second machine being subjected to static tests; it broke under a load below the minimum limit specified by technical standards.\* Static tests have been compulsory in Romania ever since.

For many years the principal method of carrying out static tests was the overloading of the main parts of the aircraft (wings, fuselage etc.) until they broke. The weights commonly used were sand-filled sacks. Because these static tests led to the destruction of a prototype, other solutions were sought.

In this field, too, the inventiveness of our experts bore fruit. At the *Astra* factory of Arad, and afterwards at *S.E.T.* of Bucharest, an original system of recording the results of the measurements was applied during static tests. It was based on the principle of communicating vessels and permitted a more judicious sizing of the elements of resistance in the structure of aircraft wings.

\* *O nouă încercare statică la noi* (A New Static Test in this Country), in the review *Aripa*, no. 5 for March 1, 1929.

## FLIGHT TESTS

The last phase in the completion of the prototype of an aircraft is its testing in flight according to a well-established programme. The decisive factor in the trials is the test pilot. We therefore wish to pay our tribute to our test pilots, who fully deserve our homage. Being the first to fly prototypes, they were invaluable collaborators of the men who conceived, designed and built the planes; they reported even the slightest indications of possible defects, which made it possible to effect the necessary changes and to finalize the model.

In view of this, the achievements of the first inventors and builders of Romanian planes like Vuia, Vlaicu and others, who not only learnt to fly, but also were the test pilots of their models, appear even more formidable. In order to help test pilots, various devices and equipments were built to record the stresses to which different parts of the aircraft are subjected during proving flights. Such an equipment was made by the late Professor *Mihail Popescu* and Engineer *Petre Augustin*. Patented in January 1961 (Patent No. 41,420), it successfully passed its tests.\*

Among our test pilots we shall mention Captains *Petre Macovei*, *Romeo Popescu*, *Radu Rusescu*, *Eugen Pirvulescu*, *Dumitru Popescu (Pufi)* and *Nicolae Iliescu*, Lieutenants *Ion Sava*, *Alexandru Papană*, *Dumitru Hubert*, *Gheorghe (Gogu) Ștefănescu*, *Octav Oculeanu* and *Gheorghe Olteanu*, N.C.O's *Foșăneanu* and *Florin Chifulescu*, and the well-known all-round sportsman *Alexandru (Dudu) Frim*.

An experimental squadron, including some of the best and most courageous pilots of the Air Force, was set up in 1929 and stationed on the aerodrome of Pipera. The task of that squadron was to carry out flight

\* Ing. I. Iacovachi, *Inventatorul român inginerul Mihail Popescu* (The Romanian Inventor Engineer Mihail Popescu), in the review *Invenții și inovații*, no. 2, 1968.



tests of all the planes that were to be taken over by the units. The squadron comprised such first-class flyers as Captain *Constantin Tănăsescu*, Lieutenants *Mihail Oprișan*, *Nicolae Ionescu-Beu*, *Nicolae Țiculescu*, *Gheorghe Pienescu* and others.

Before closing this short chapter about flying tests, we record the names of the men who endorsed the birth certificates of Romanian planes built in recent decades: test pilots Captains *Ion Milu* and *Nicolae Grama*, and Masters of Sports *Constantin Manolache* and Colonel *Octavian Băcanu*. Test pilots of Romanian-built gliders include *Valentin Popescu*, Engineer *Emil Iliescu*, Engineer *Mircea Finescu*, and *Ovidiu Popa*, Masters of Sports.

Mimimata idee de a scrie pentru prima oară, sub această formă, o antologie a aripilor românești, care să illustreze abilit de grăitor local pe care geniul creator românesc îl ocupă cu drepturi depline în ierarhia zborului mondial.

Șase decenii și jumătate care se pot rezuma în cite-va evenimente de seamă: 1906, primul aparat mai greu de cântăreț, s-a desprins de la pământ cu mijloace proprii; 1910, primul avion de concepție românească construit în țară, zboară cu succes pe câmpul Cotroceniilor și primul avion cu reacție, creații ale românilor Vuia, Vlaicu și Coandă, iar în 1969 primii pași ai omului pe lună, datorită forței reactive.

Aceasta este drumul și noi românii am fost printre pionieri. Este într-adevăr minunat!

General inginer aviator  
Gheorghe Negrescu

It has been a wonderful idea to write this first anthology of its kind of Romanian wings, so strikingly illustrating the rank held by Romanian creative genius, with the fullest justification, in the hierarchy of world aviation.

Six and a half decades, summed up by several peak events: **1906**, the first heavier-than-air machine takes off under its own power; **1910**, the first Romanian-designed aeroplane built in this country makes a successful flight on the field of Cotroceni, and the first reaction-propelled aircraft — creations of the Romanians Vuia, Vlaicu and Coandă; and in **1969**, man makes his first steps on the Moon, thanks to the reactive thrust.

That is the way, and we Romanians were among the pioneers. It really is wonderful!

The first part of the paper is devoted to a  
general introduction of the subject and  
to a description of the various methods  
which have been employed in the study  
of the problem. The second part is  
devoted to a detailed description of the  
method which has been employed in the  
present study. The third part is devoted  
to a description of the results which  
have been obtained. The fourth part  
is devoted to a discussion of the  
results and to a comparison of the  
present results with those obtained  
by other workers in the field.

Received by the Editor, June 1, 1954  
Revised manuscript received, July 1, 1954  
This work was supported by the  
National Science Foundation  
Grant No. G-10080



ROMANIAN  
AIRCRAFT  
CONSTRUCTIONS



- CHARACTERISTICS
- PERFORMANCE
- DESCRIPTIONS
- SILHOUETTES

1840  
1841  
1842

41

1843  
1844  
1845  
1846

# AEROPLANES

1917, 1918, 1919

The history of aeroplanes is a story of rapid progress. In 1903, the Wright brothers made the first powered, controlled, and sustained flight. This was followed by a series of improvements in engine power, wing design, and control systems. By 1914, aeroplanes were being used for military purposes, and the First World War saw the development of the biplane and the monoplane. The war also led to the development of the engine-driven propeller and the use of aeroplanes for transport and mail delivery. In 1919, the first transatlantic flight was made by the non-stop flight of the *Noonian* from New York to Paris. This was followed by the development of the multi-engine aeroplane and the use of aeroplanes for long-distance transport. The 1920s and 1930s saw the development of the high-speed monoplane and the use of aeroplanes for military and transport purposes. The Second World War saw the development of the jet engine and the use of aeroplanes for military and transport purposes. The 1940s and 1950s saw the development of the jet engine and the use of aeroplanes for military and transport purposes. The 1960s and 1970s saw the development of the jet engine and the use of aeroplanes for military and transport purposes. The 1980s and 1990s saw the development of the jet engine and the use of aeroplanes for military and transport purposes. The 2000s and 2010s saw the development of the jet engine and the use of aeroplanes for military and transport purposes. The 2020s and 2030s saw the development of the jet engine and the use of aeroplanes for military and transport purposes.



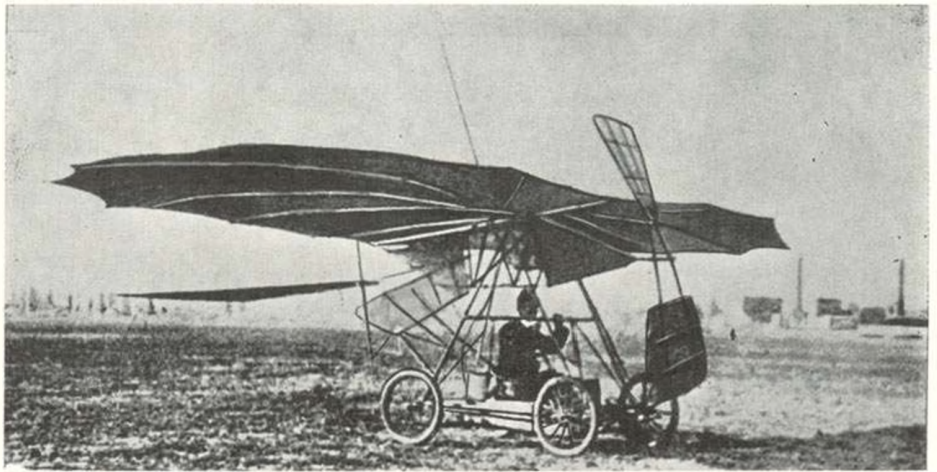

### VUIA No. 1 (1905)

Span 7.00 m, overall length 3.20 m, wing area 19.00 sqm, airscrew disk-area 2.20 m, airscrew pitch 2.40 m, maximum take-off weight 241 kg, 20 HP Serpollet engine, radically transformed by Vuia, weight of engine (with accessories) 105 kg.

As reported by Charles Dolfus and H. Bouché in their volume *Histoire de l'Aéronautique*, the *Vuia No. 1* aeroplane was completed in 1905. The machine was tested on the communal road between Montesson and the Seine on March 18, 1906; the plane, flown by its inventor and builder, the Romanian aviation pioneer *Traian Vuia*, covered a distance of 12 m at a height of nearly 1 m. This was the first flight in the history of aviation of a heavier-than-air machine which took off from the soil under its own power without any auxiliary means or devices.

The *Vuia No. 1* was a parasol monoplane, its wings being attached to the upper part of a mobile (tilting) metal frame which, together with the fixed lower chassis, made up the skeleton of the machine. The two wings could be folded and made up like an umbrella so that the plane could travel on the soil and be parked. The upper frame carried the engine, the airscrew and the rudder. The lower chassis had four wheels with tyres, the front wheels having shock-absorbing springs and being castorable. On the lower chassis the following components of the engine were mounted: the generator (a boiler which vaporized the carbonic acid gas), the acid gas tank, the kerosene tank (the burning of which was giving the necessary vaporizing temperature), the rudder and engine control devices, as well as the pilot seat. The link between the lower chassis and the upper frame was

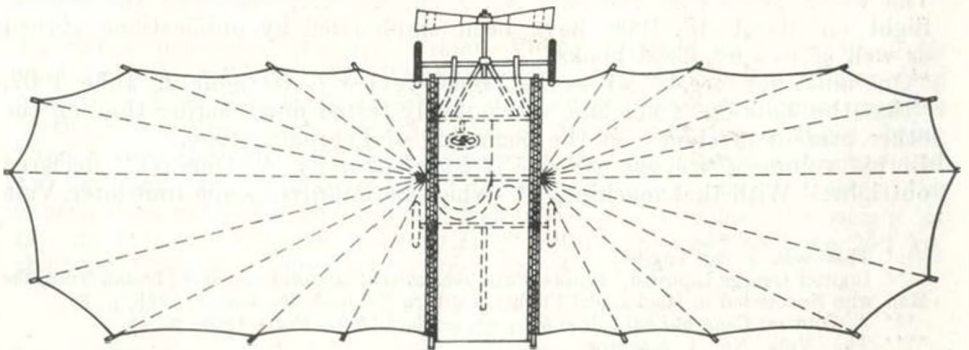
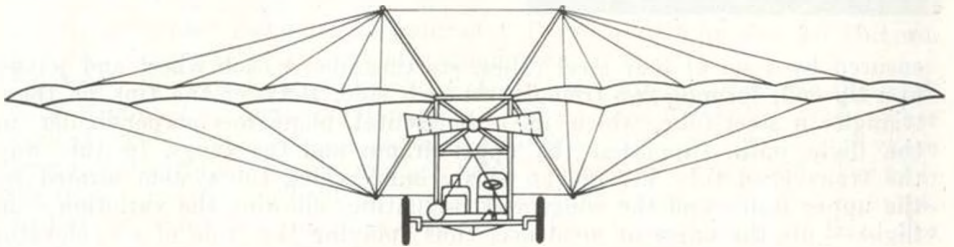
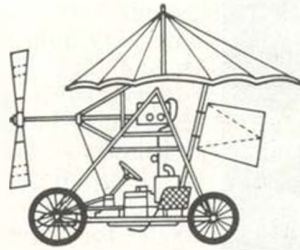

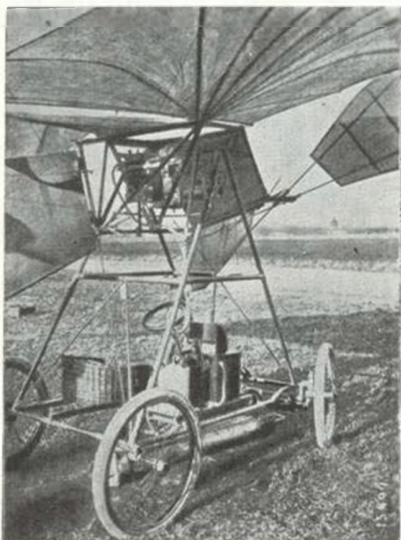

The metal framework of the *Vuia No. 1*.

ensured by a set of four steel tubes, starting above each wheel and joined in a tip end, forming two triangles on each side. Between the tips of these triangles a steel tube, which in a horizontal plane was perpendicular to the flight path, supported the upper frame and the wings. In this way the transversal tube became an axis around which the system formed by the upper frame and the wings was oscillating, allowing the variation — in flight — of the angle of incidence, thus playing the role of an elevator (during its first flights, Traian Vuia's machine had no elevator). Hence, *Traian Vuia was the first in the world to build wings with variable incidence during flight*, an idea taken up later by other aircraft constructors.

The Vuia aeroplane's specific features compelled the inventor to make a motor especially conceived for it. He used a Serpollet\* steam engine, which he radically transformed, adapting it to work with carbonic acid gas.\*\* The resulting plant had a power of 20 HP.

The world priority of the *Vuia No. 1* and the importance of the historic flight on March 18, 1906, have been emphasized by publications abroad as well as in specialized books.

"One must not forget," wrote the French review *L'Aérophile* in June 1907, "that the *Vuia No. 1* machine was publicly tested much earlier than all the other present machines: at the beginning of February, 1906."

In his volume *Ceux qui ont volé et leurs appareils*, A. Dumas\*\*\* declared outright: "With that machine,\*\*\*\* which he improved some time later, Vuia

\* This was a car engine.

\*\* Inginer George Lipovan, *Traian Vuia, realizatorul zborului mecanic* (Traian Vuia, the Man who Succeeded in Mechanical Flight), Editura Tehnică, Bucharest, 1956, p. 86.

\*\*\* A. Dumas: *Ceux qui ont volé et leurs appareils*, L'Aéro, Paris 1909, p. 16.

\*\*\*\* The Vuia No. 1 machine.



carried out the first flights at Montesson before Santos-Dumont tested his wings above the lawn of Bagatelle.”

An article published in no. 48 of the world known French magazine *l'Aéronautique* of 1923, said: “Traian Vuia, who was one of the modest and interesting forerunners of powered flight and who, let us recall, succeeded in leaving the soil and covering a distance of several metres on board of his aeroplane powered by an engine using carbonic acid gas, on March 18, 1906, before Santos-Dumont, has continued his aviation research and concerned himself with the helicopter concept.”

More recent assessments are just as conclusive. For instance, in his article printed in *Aviation Magazine* of 1956 for the 50th anniversary of the first flight carried out by Traian Vuia, André Bié said: “Vuia succeeded with a masterly stroke in overcoming the initial difficulties... Vuia adopted a four-wheel landing gear, the first to be equipped with tyres... Far from copying devices planned before him, he made comprehensive innovations and his ideas were more logical than those that had appeared before...”

Eloquent praise for Traian Vuia's flights came from C. Dollfus,\* one of the greatest specialists in the history of aeronautics, on the occasion of the *Aviation 1906* Exhibition organized in Paris in 1956 by the Air Museum and the Aviation Semi-Centenary Committee:

“In order to respect chronology,” he said, “we must first welcome the work of a modest but remarkable pioneer, Traian Vuia. With his own, rather limited means, he built an aeroplane between 1903 and 1905... whose frame of steel tubes was surprisingly solid for the time. The engine was fuelled from a jar with carbonic acid gas, permitting operation for 3-5 minutes. Tested at Montesson on March 18, 1906, Vuia's plane took off from the ground and covered a distance of 12 m at a height of one metre.”

“On July 1 and on August 12 and 19, at Issy-les-Moulineaux, Vuia succeeded in carrying out flights of about 10 m, concluded with a jump of 24 m at a height of 2.50 m... These were modest performances, but the time at which they were achieved increases their value. M. Vuia himself offered the component parts of his aeroplane to the Air Museum... Rebuilt by M. Raymond Picart, this aeroplane will become one of the treasures of our collections.”

Following successive changes, Traian Vuia completed his *Vuia No. 1-bis* in the month of August 1906. The wings of this machine had a smaller wing camber and an orientable stabilizer, improving the aerodynamic qualities of the plane. The wing's incidence was no longer adjusted in flight, being fixed before the take off. The efficiency of the engine was also improved by increasing the airscrew's speed to 930 turns per minute. During the experiments made by the builder with the *Vuia No. 1-bis*, the weight of the machine was changed several times. Initially planned to have 240 kg, the weight of the machine eventually reached 275 kg.

\* C. Dollfus, *L'année aéronautique 1906*, Paris, 1956, pp. 5-8.

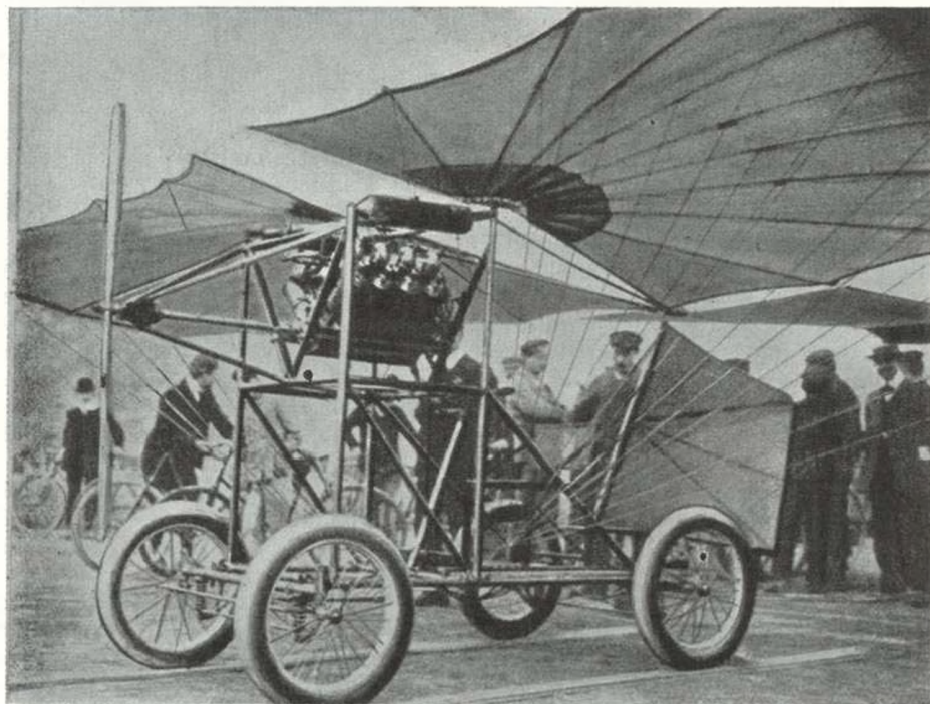

### VUIA No. 2 (1907)

Span 7.90 m, wing area 17.00 sq m, diameter of the propeller 1.80 m, propeller pitch 1.10 m, total weight 213 kg, 24 HP Antoinette engine, weight of engine 85 kg.

In comparison to the first model (the *Vuia No. 1* and its variant *No. 1-bis*, built by *Traian Vuia*), the *Vuia No. 2* had several novelties. For instance, in order to improve flight performance, the *Vuia No. 2* had an internal combustion eight-cylinder engine of 24 HP of the Antoinette type, which weighed only 85 kg.

The 4.5-litre fuel tank was placed above the engine, which rested on an aluminium tube support. In the rear part of the plane were the rudder, a stabilizer and an elevator. Shock-absorbing springs were provided for the rear wheels.

During its last flight on the field of Bagatelle, on July 17, 1907, the *Vuia No. 2* covered a distance of 70 metres.

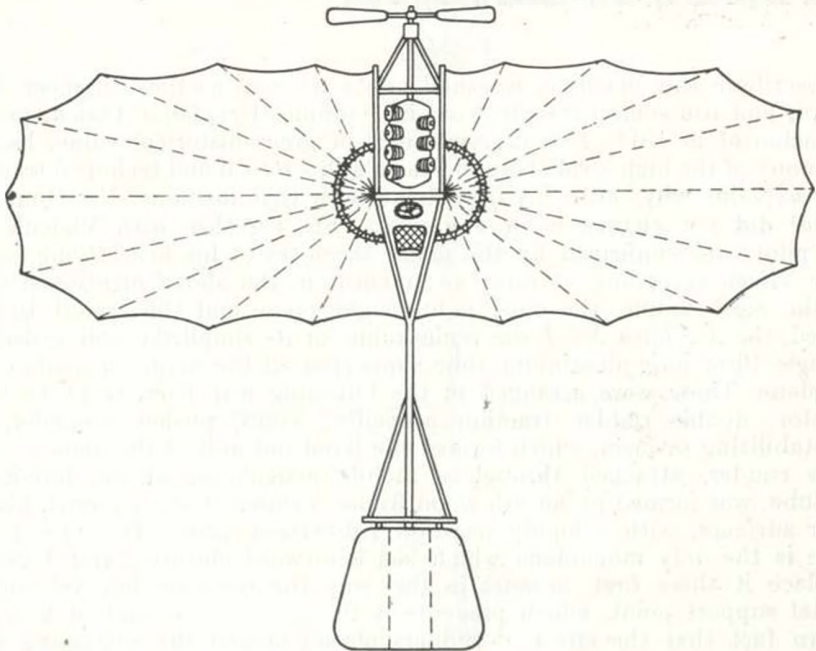
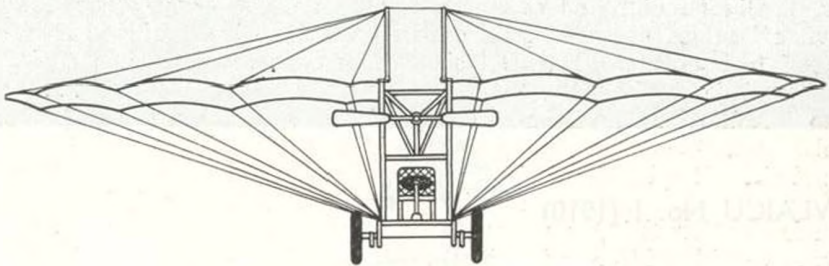
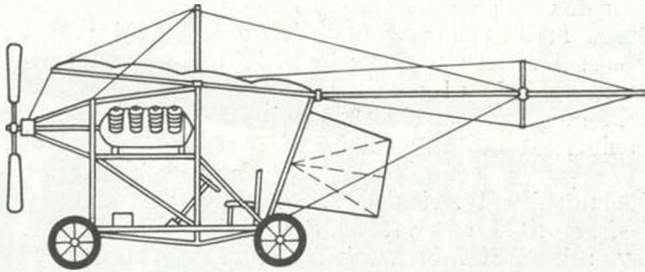



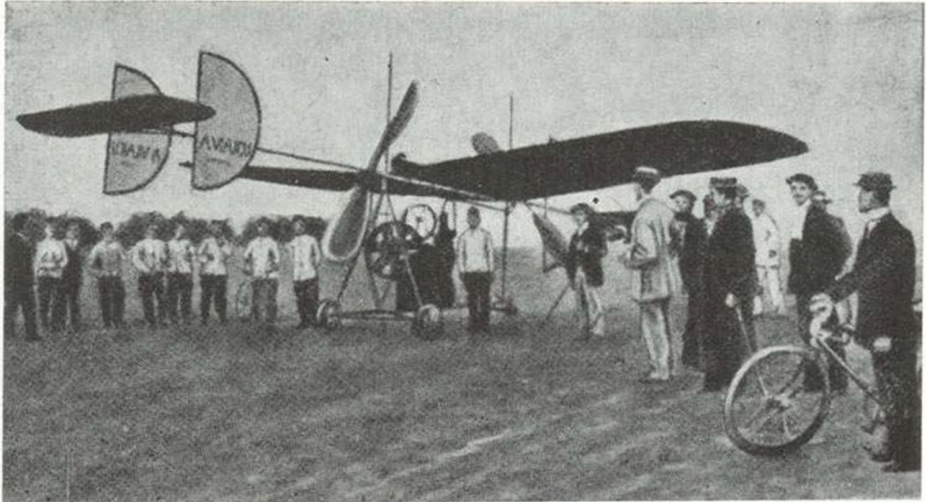

#### A. VLAICU No. 1 (1910)

Span 10.00 m., overall length 12.00 m., overall height 4.22 m., wing area 25.00 sq m., maximum take-off weight 300 kg., 50 HP Gnôme (rotary) engine.

In describing this machine, we shall quote its constructor, Engineer *Aurel Vlaicu*, and use some excerpts from his volume *Aeroplanul Vlaicu*, printed in Bucharest in 1911. This description is of great historical value, being a testimony of the high level of Aurel Vlaicu's theoretical and technical training. That explains why, after his first flight with that machine, the Romanian builder did not change it in any way. This, together with Vlaicu's skill as a pilot, was confirmed by the many successes of his brief flying career. "The Vlaicu aeroplane," wrote the inventor in the above mentioned book, "is the most simple, the most light-weight plane and the easiest to fly." Indeed, the *A. Vlaicu No. 1* was remarkable for its simplicity and resistance. A single 10-m long aluminium tube supported all the main elements of the aeroplane. These were arranged in the following way from front to back: elevator, double rudder, traction propeller, wings, pusher propeller, and the stabilizing surfaces, which formed the fixed tail unit of the plane.

"The rudder, attached through a mobile articulation at the fore-end of the tube, was formed by an ash wood frame, cambered and covered, like the other surfaces, with a highly resistant rubberized fabric. The Vlaicu aeroplane is the only monoplane which has a forward elevator, and I decided to place it there first, because in this way the machine has yet another frontal support point, which prevents it to nose-over; second, it is a well-known fact that the effect of rudders placed behind the sustaining wings

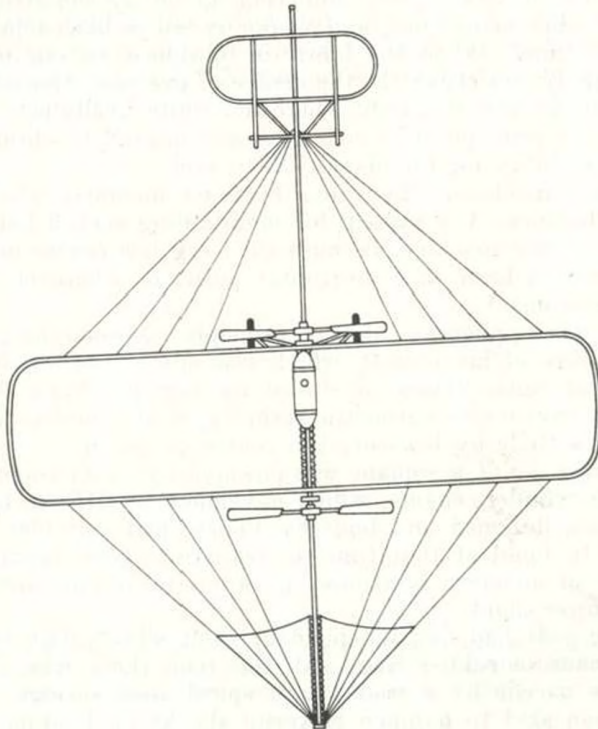
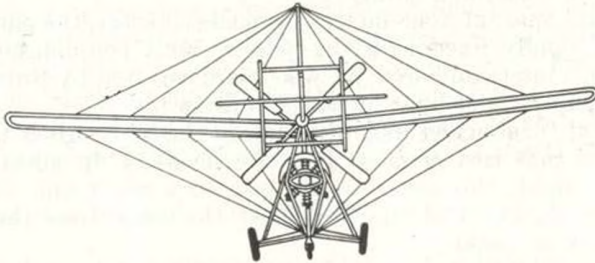
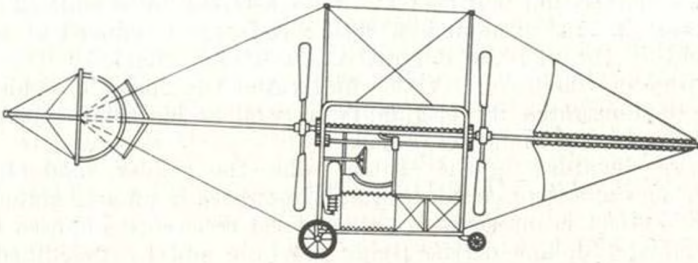

is degressive, whilst that of those placed before the wings is progressive. I therefore consider that it is better to have a latent force which I could use to the utmost in critical moments, rather than to be reduced to an incapacity of fighting through the degressiveness of the effect."

The clear way in which Aurel Vlaicu motivated the concept of his machine strikingly demonstrates its originality as well as his solid scientific aeronautical know-how. Vlaicu continued:

"Behind the elevator, on the central tube, the rudder, made up of two parallel surfaces of a semi-circular form, is mounted in an articulated manner. The rudder's effect is increased by the lateral resistance opposed to the air by the vertical tailplane of the flying machine and by the dihedral angle formed by the sustaining wings...

"On the central spar, at four metres from the elevator, the parabolic sustaining wings are rigidly fixed with the help of steel couplings. Their frames, made of drying closet cambered fir wood, are covered by water-proof fabric, and are the simplest and lightest wings built so far.

"The system of turnbuckles and wires inside the wings gives the fabric such a high tension that ribs or cross bars are needless. In addition to making the wing very light, this also reduces drag to a minimum, its profile being limited to the thickness of the frame. At the same time the wing is very cheap and easy to make.

"The wing has no transverse cambering, given by the structure of ribs in the case of other aeroplanes, and whose sweep is placed in about the first third of the chord. When the fabric is tightened, in our machine appears a camber highly concordant to the centre of pressure, this consistency being only the best, because it is right where this centre really is."

Explaining the principle on which he based himself to obtain the best possible flight stability for his plane, Vlaicu said:

"Unlike other machines, the wings have no members whatever to ensure the lateral balance. Any system for maintaining such a balance is needless in the case of our machine, because the very low centre of gravity always tends to bring it back to a horizontal position, whatever the disturbance of the air streams."

Considering the application of this principle as something quite natural in the structure of his aircraft, which was one of the few high-wing monoplanes of that time, Vlaicu concluded by saying: "Why should we follow complicated ways for an automatic stability, if the simplest law of mechanics provides us with it by lowering the centre of gravity?"

The *A. Vlaicu No. 1* aeroplane was powered by an air-cooled *Gnome-Omega* radial seven-cylinder engine, which developed 50 HP at 1,200 r.p.m. The two airscrews, designed and built by Vlaicu, had only 600 rpm, wherefore Vlaicu had to build at that time a reduction gear capable of reducing the number of airscrew rotations in order to obtain optimum efficiency from the power plant.

The landing gear had two independent front wheels with tyres and shock-absorbers made of rubber rings. At the rear there was a smaller wheel fixed to the nacelle by a cradle with spiral steel springs. The plane also had a median skid to dampen powerful shocks on landing; as a matter of



fact, in the words of Vlaicu, its purpose rather was to be "... a kind of safety device for those who begin to learn to handle the machine."

The steering system was formed of a wheel which was revolved in order to raise or lower the elevator, and laterally moved to action the rudder in the desired direction. Summing up the flight qualities of his machine, Vlaicu added: "... This steering system allows you to pilot with one hand, whilst the other can open a map, take a photograph or throw a bomb."

A patriot who foresaw the possibility of using aeroplanes for military purposes as far back as 1910, Vlaicu repeatedly voiced the ardent desire to place his machine in the service of his country. This is what he said in the last pages of the publication in which he presented his aeroplane:

"From the military point of view, our aeroplane is the most suitable because:

- (a) the pilot can look in all directions, being seated below the wings;
- (b) he can glide at very low speed in order to reconnoiter the terrain very well and, after reconnaissance, he can travel very fast in order to communicate the result of his observations;
- (c) thanks to its low weight, the machine can rise within a few minutes to a height of over 1,000 m, avoiding enemy fire or the attack of enemy aircraft;
- (d) the machine can be easily disassembled, and can be transported by a car or cart."

Flying his No. 1 machine, Vlaicu took part in the general manoeuvres of the Romanian army held in the autumn of 1910. This was the first time in Romania that aviation was used in support of the army, and the second instance of its kind in the world.\* Numerous successful training and demonstration flights encouraged Vlaicu to build another and better aircraft.

\* A plane was first used for military purposes in France. On June 9, 1910, Lieutenant Féquant and Captain Marconnet carried out a reconnaissance mission. That year French aircraft were also used during the army manoeuvres held in Picardie (C. Dollfus and H. Bouché, *Histoire de l'Aéronautique, l'Illustration*, Paris, 1932, p. 238).

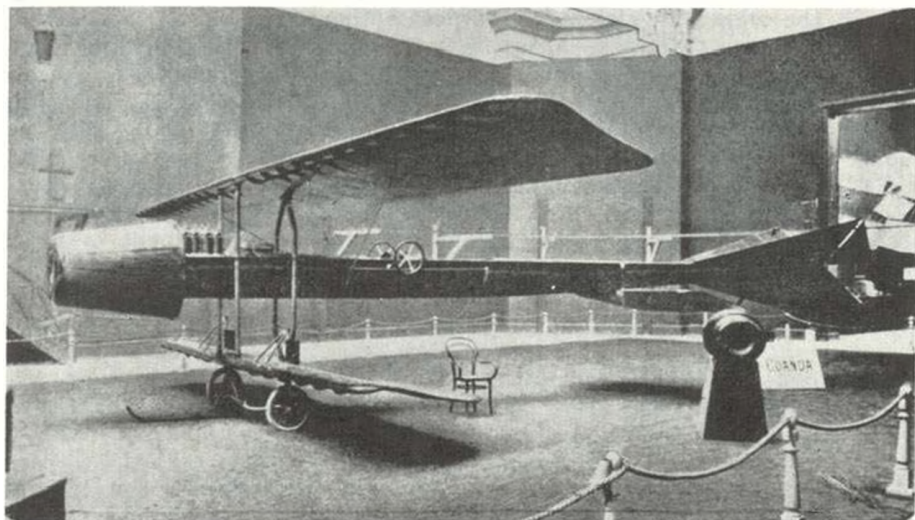

## COANDĂ — 1910

Span 10.30 m, overall length 12.50 m, wing area 32.70 sq m, maximum take-off weight 420 kg, power plant: turbo-prop (an original reactive engine with centrifugal compressor); thrust 220 kg.

This plane was presented in Paris in 1910 at the Second International Aeronautical Salon. Although many machines of the best-known aircraft builders of the time were on show at the Grand Palais, the *Coandă-1910* aroused a great deal of interest thanks to its novelty. Striking proof is given by the assessment of Georges Espitalier, the director of the review *La Technique Aéronautique*,\* who wrote:

“The Coandă aeroplane is one of those rare machines in which everything is new, and the judicious and rational way in which the inventor abandoned the well-trodden road in that direction, in order to face the risks of the unknown, is a sufficiently strong reason for us to carefully examine the means used by the inventor in his construction.”

The most original element of the propellerless plane built by the young Romanian engineer *Henri Coandă* was undoubtedly the power-plant, which was altogether unusual for those days. It was a reactive engine, according to the reaction engines classification being a motoreactor.\*\* It consisted of a “classical” reciprocating engine, a 50-HP *Clerget*, which — by

\* *La Technique Aéronautique*, no. 21, 1910.

\*\* H. Coandă called it, at that time, a “turbo-prop”.

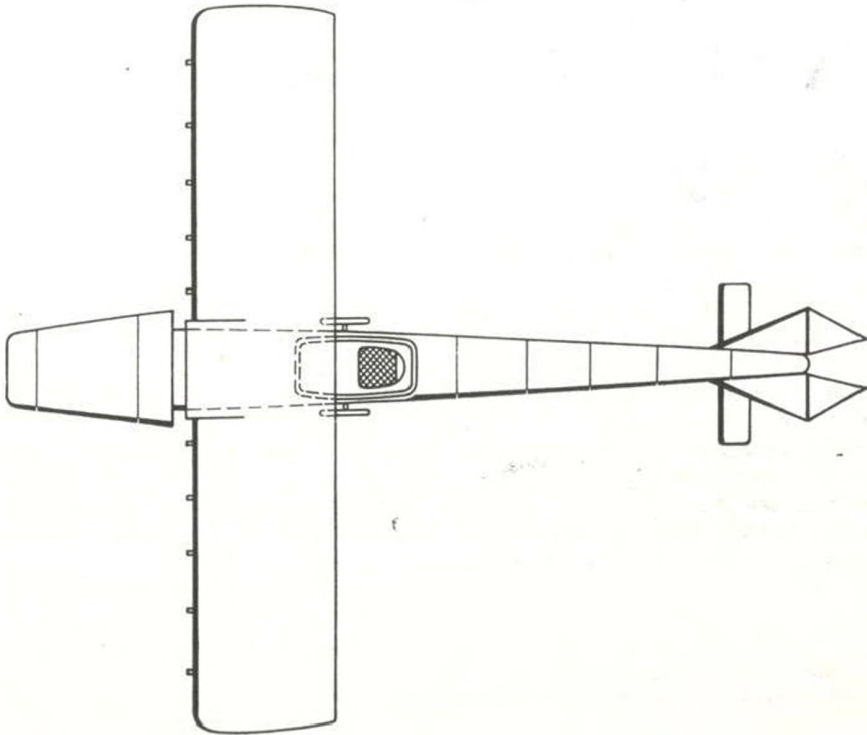
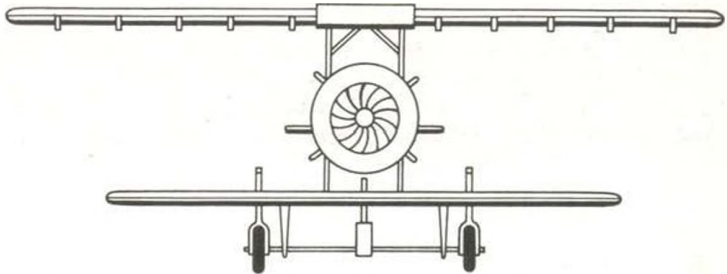
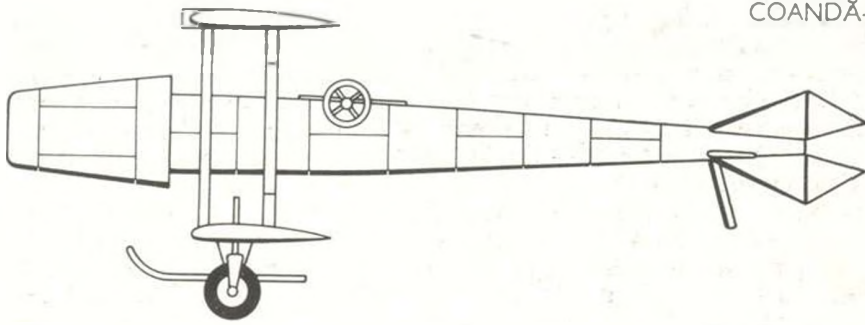



means of a crankshaft and of a rounds multiplier — actioned a centrifugal supercharger. The aspired air, of which the flow was regulated by a nugget, was repressed in several combustion chambers where the fuel was also sprayed. The resulting mixture was fired when contacting the burned gases arriving from the engine, then thrown out through jet ejectors, thus creating a thrust (reaction force) — the holding point value of which was of 220 kg (with opened nugget).

The plane on which this engine was mounted also had a number of original elements resulting from the daring concept of the constructor. Although a biplane, the machine had only two pairs of struts, without webs, which demonstrated the high resistance of the wings, whose frame, formed of two steel spars each (frontal and hinder) at each wing, with the respective ribs, permitted a wing-load of up to 33 kg/sq m, as against 25 kg sq m supported by the most resistant aeroplanes of those days. Another original element was the idea of the leading edge slotted flap of the wings, which served as a lift-augmentation device.\*

The shell-type fuselage and the plywood cover of the wings and fuselage, painted, polished and lacquer-finished, lent the plane superior aerodynamic features and a reduced drag. It was also Henri Coandă's idea to place the fuel tanks in the wings, a solution that was applied much later by other aircraft constructors.

The tail unit of the aeroplane, formed of four fixed triangular fins (placed diagonally in the form of a cross), each extended with a mobile surface, also of a triangular form, was yet another original element, because it helped the control of all pitching, yaw and rolling movements.

Before the tail unit was placed a small span fixed surface, working as a stabilizer.

On both outer sides of the fuselage, near the cockpit, were two wheels actioning the aircraft's controls. By rotating both wheels in the flying direction one obtained a descent movement, while rotating them in the opposite sense resulted in a nose-up movement. The action of only one wheel entered the plane in a turn, tilting it on the desired side.

The landing gear, low and very solid, and partially retractable, had two wheels and a prolonged skid between them (to prevent capsizing); another skid sustained the tail unit. The wheels of the landing gear were elastically suspended by steel flat springs.

By and large, the plane designed and built by the Romanian engineer Henri Coandă was, to quote André Bié,\*\* “a veritable vanguard example.” After the International Aeronautical Salon, at which it was on show, had closed its gates, the plane was taken to the field of Issy-les-Moulineaux to undergo test flights. On December 16, 1910, the plane lying on the ground with the engine idling, Henri Coandă entered the cockpit in order to verify the controls. There, he involuntarily pushed the gas handle, causing an

\* This solution was applied in 1918 by the British Handley Page Company, the device being known as the Lahmann Handley Page flap.

\*\* André Bié, in the review *Aviation Magazine*, no. 160, 1955.

unexpected and swift take-off. The aircraft took height after a very short run, but due to Coandă's lack of flying training it began to lose speed, entering an uncontrolled descent that finished with a crash. The machine was wrecked and the inventor severely hurt. Lack of financial means prevented a reconstruction.

But there is no doubt whatsoever, that by making his reaction-propelled plane Henri Coandă helped world aviation to score its present successes.

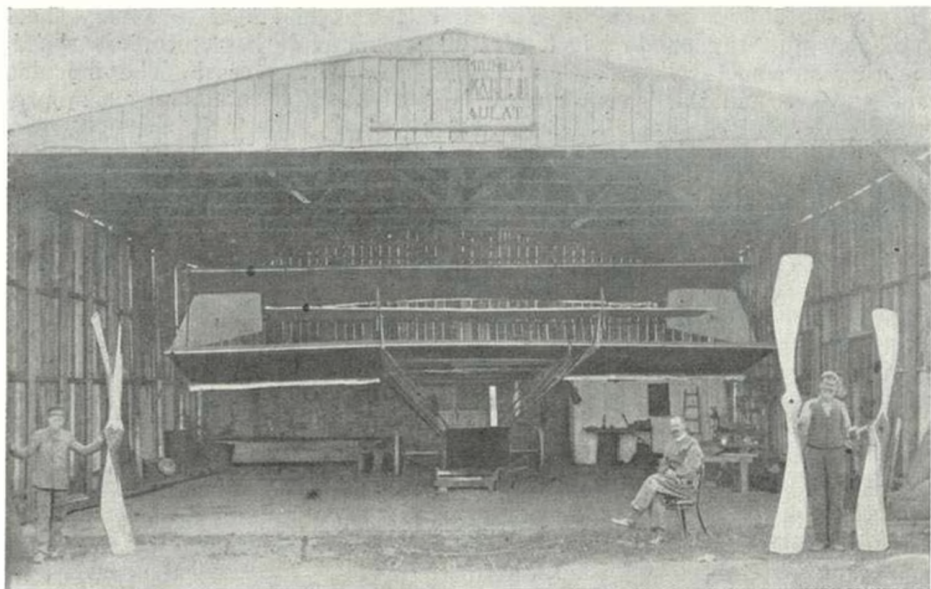

### The ION PAULAT flying-boat (1911)

Span 13.20 m, overall length 11.50 m, overall height 4.50 m, wing area 69.60 sq m, maximum take-off weight (with pilot and fuel for one hour) 520 kg, maximum speed (rated for both engines) 85 km/h, horizontal speed (rated for one engine only) 35 km/h.

According to the description given by *Ion Paulat*, the flying-boat had a hull made from oak and ash wood, and the side ribs from elm; it was covered with rubberized and metallized fabric. The wheels were to act not only for movement on land but also to increase floatability; being hermetic and floatable, the wheels helped to increase lateral stability. During the take-off on water, they were raised so as not to slow down the machine. The wings, with an ash wood frame, were also covered with rubberized and metallized fabric. The front wing had two mobile surfaces which served as lateral stabilizers; the wing was of an oscillating type, which made it possible to change the centre of gravity in case of gusts.

Ion Paulat's flying-boat was presented in the magazine *Flugsport* of Frankfurt. The author of the article, published in the issue dated May 6, 1911, said in conclusion: "This construction of a new type marks a new progress in aviation, which will certainly give satisfactory results."

Although Paulat's flying-boat did not succeed in carrying out conclusive flights because it lacked the second engine, it was one of the first flying-boats in the world.



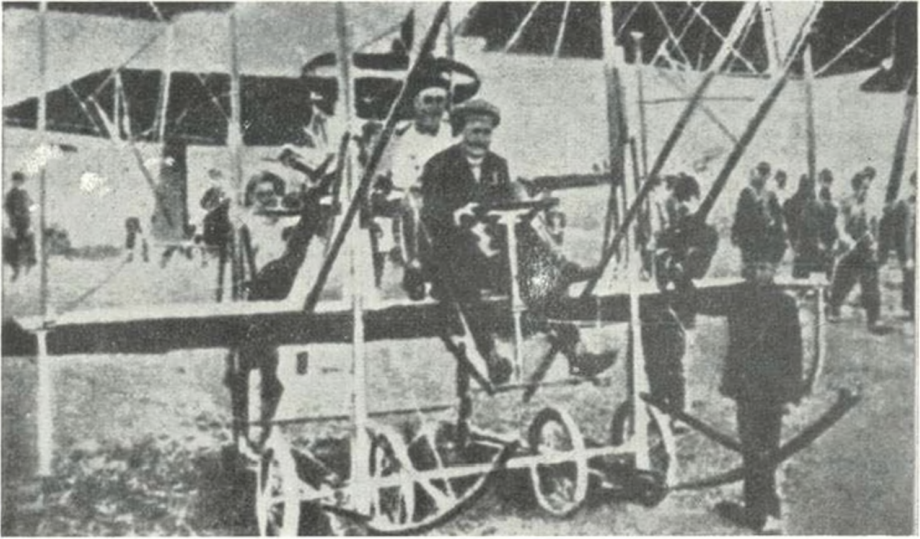

## COLUMBA (1911)

*Dumitru (Tache) Brumărescu* named his plane *Columba* because it looked like a pigeon in flight. The machine had certain novel devices, for instance a supplementary horizontal airscrew in front of the fuselage, whose purpose it was to facilitate the take-off. Also on the forward side of the machine were the elevator, and the tractive propeller. Two air tanks were provided to pressure the aircraft's floatability, when necessary. The design of this original combination of aircraft, helicopter and amphibian was patented at the Romanian Office of Inventions under No. 1,844/1909 and its scale model was on show at Liberty Park in Bucharest, where it aroused the lively interest of specialists and newspapermen.

With the backing of the Romanian journalists' trade union and of scientists such as Dr. C. I. Istrate and Dr. Mina Minovici, Brumărescu left for Paris where the model of his machine was on show at the International Aeronautical Salon, at the same time as Coanda's aeroplane. After returning from Paris, where he attended the courses of a flying school, Brumărescu succeeded in building his machine.

It is worth noting that the 50-HP *Gnome* engine of Brumărescu's machine was bought with money resulting from a subscription and a subsidy given by the Minister of Public Education, Professor Spiru Haret.

The flight test was carried out on the field of Cotroceni on May 27, 1911, the machine being piloted by its builder. After a run on the ground, the plane made several hops of about 2 m each, and then struck the soil and was damaged. Because of lack of funds and official support, Dumitru Brumărescu was unable to repair his machine and discontinued his aviation experiments.

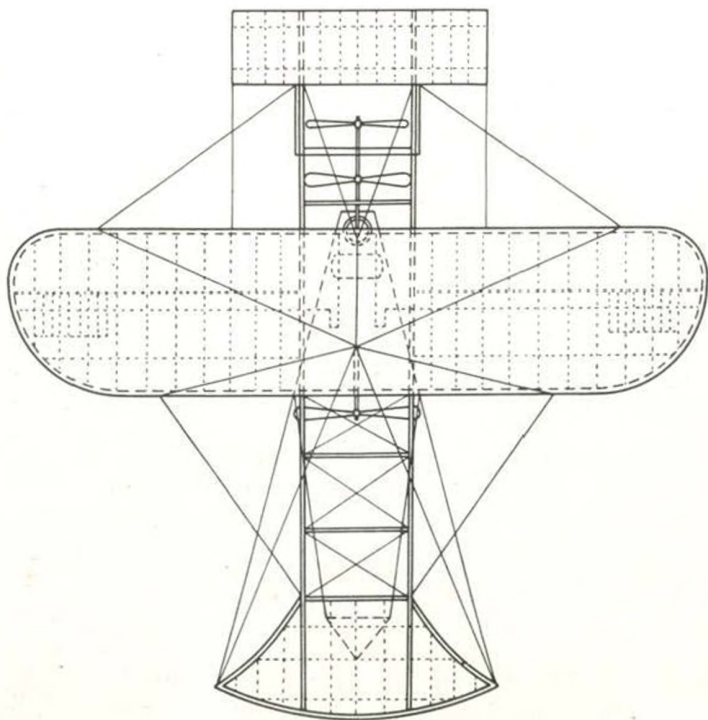
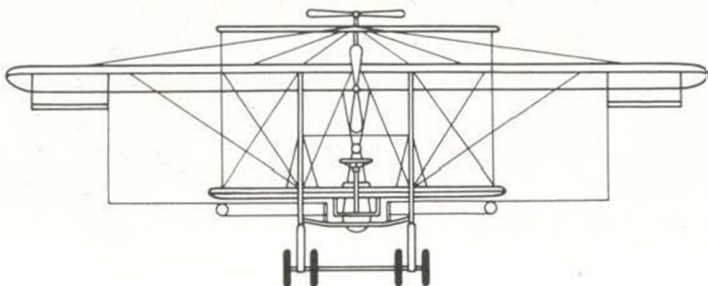
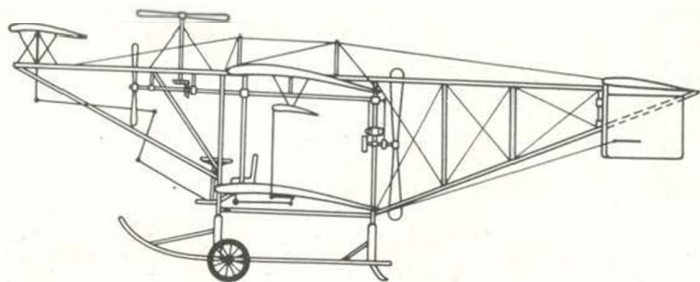

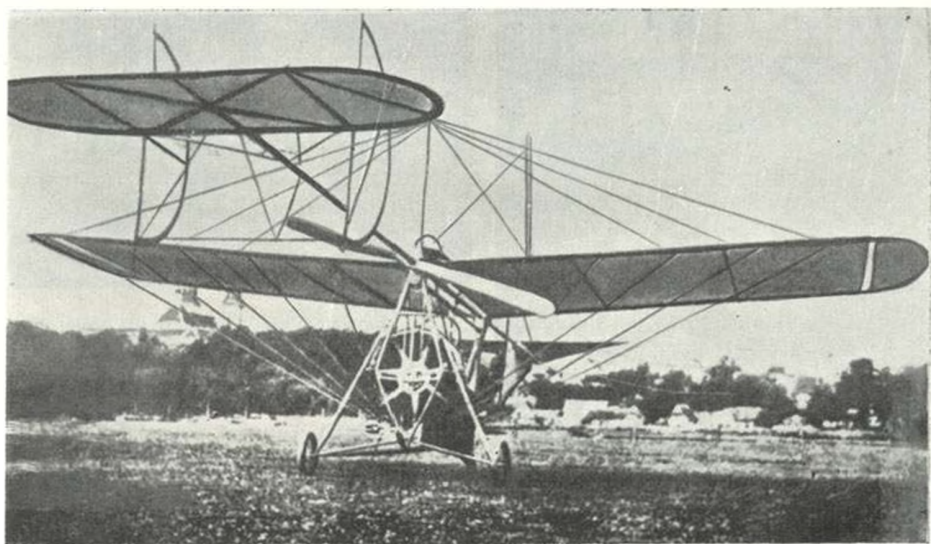

### A. VLAICU No. II (1911)

Span 10.00 m, overall length 11.20 m, overall height 4.20 m, wing area 26.00 sq m, maximum take-off weight 300 kg, 50 HP (rotary) Gnôme engine, maximum speed 110 km/h, landing speed 60 km/h, take-off run 40–60 m, landing run 20–30 m.

*Aurel Vlaicu* completed his second plane, the *A. Vlaicu No. II*, in April 1911. Like his forerunner, this machine, too, flew, as Vlaicu reported in an article published in the review *Viața Socială*, “from the very start, without any modifications, as it was calculated from the first day.” In comparison with the first machine, the changes and improvements were the following: a shortening of the aluminium tube (the main longeron), the fabric covering of the nacelle, the reduction of the diameter of the driving wheel, the provision of dashboard instruments (rpm indicator, speedometer and altimeter, which the *A. Vlaicu No. I* did not have), the tail wheel completed with a braking device (Vlaicu being the first constructor to use a brake on the aircraft wheels), the mounting of a new engine carburettor (improved by Vlaicu), and the replacement of the airscrews with two others of a new type, also made of wood, having a higher efficiency, built by Vlaicu’s good friend G. Magnani.

On that plane Vlaicu carried out successful demonstration flights at Blaj on July 16, 1911, Sibiu, on September 11, 1911, and Ploiești, in 1912. Aurel Vlaicu also became well known abroad following his successful participation in the international aviation contest held in June 1912 at Aspern,





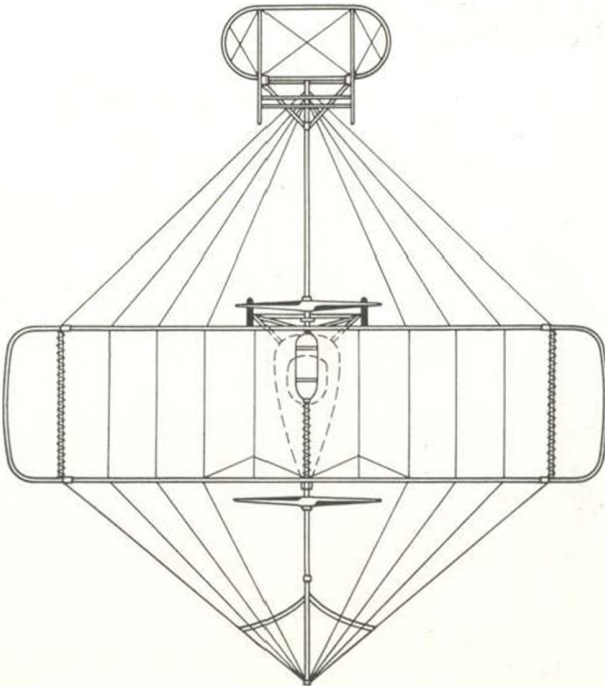
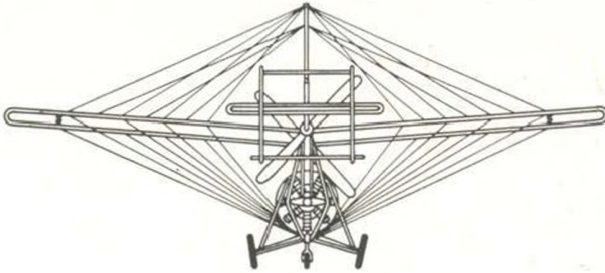
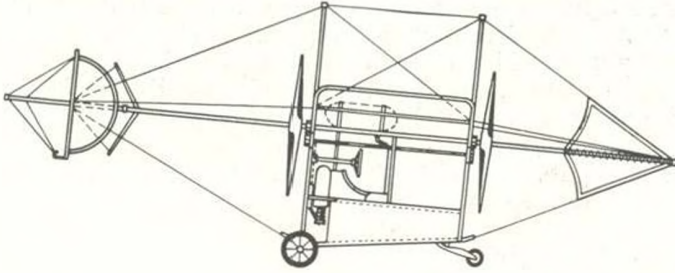

the plaque reads: "On this airport, participating in an international aviation competition held between June 23 and 29, 1912, the Romanian flyer and inventor Aurel Vlaicu, one of the pioneers of world aviation, placed first with a flying machine of his own construction."

Between July and September 1912 Aurel Vlaicu carried out his second series of flying tournaments with the *A. Vlaicu No. II* at Arad, Lugoj, Hațeg, Orăștie, Virșeț, Săliște, Tîrgu Mureș and Ibașfalău. These were among the last major flights with the *Vlaicu No. II*.





## THE AIRCRAFT OF NICOLAE SARU-IONESCU (1911)

No technical data of the construction or flight performances of the plane built by *Nicolae Saru-Ionescu* could be ascertained. It is known, however, that the test flights of the plane, piloted by its builder, took place between July 22 and August 28, 1911, on the field of Cotroceni, at the time of the memorable demonstration flights carried out by some of the first Romanian flyers — *Aurel Vlaicu*, Lieutenant *Nicolae Capşa*, Lieutenant *Andrei Popovici* and *George Valentin Bibescu*. News items\* in the papers point to the existence of the plane and its tests. *Aurel Vlaicu*, who saw one of those flights, declared that *Saru-Ionescu's* machine was "a valuable achievement that would succeed."

It seems that, because of lack of funds, *Nicolae Saru-Ionescu* did not repair his plane after the damage the machine suffered in an accident that occurred on August 28, 1911, during a flight at Cotroceni. The drawings in this volume were made after the original drawings of the builder, put at our disposal by his family.

**Dimineața**  
CARE DIMINEAȚA CU CELE DIN URMA

AVIATORII NOSTRI

**Aeroplanul N. Ionescu**

— Un aparat nou, foarte serios, care a făcăt noul nostru

Noul aparat de zburat al d-lui N. Ionescu.  
Sus: aparatul în hangar.  
Jos: în vedere generală a aeroplanului.

\* *Dimineața*, no. 2651 for July 22, no. 2653 for July 24, no. 2662 for August 2, and no. 2689 for August 29, 1911.

THE AIRCRAFT OF NICOLAE SARU-IONESCU

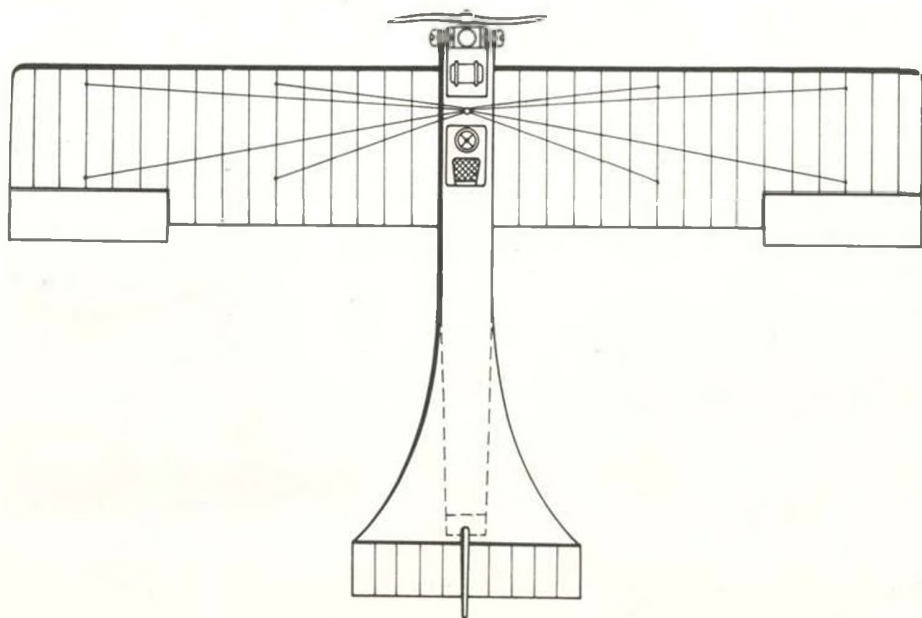
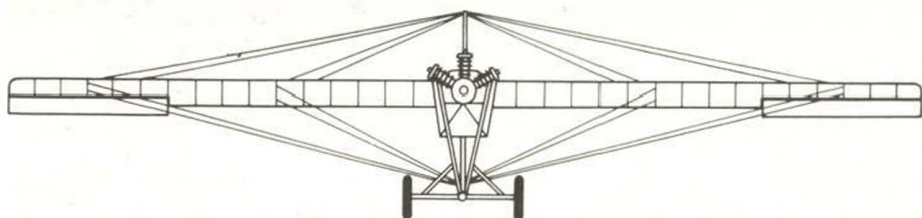
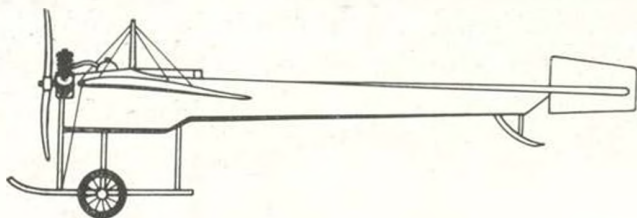

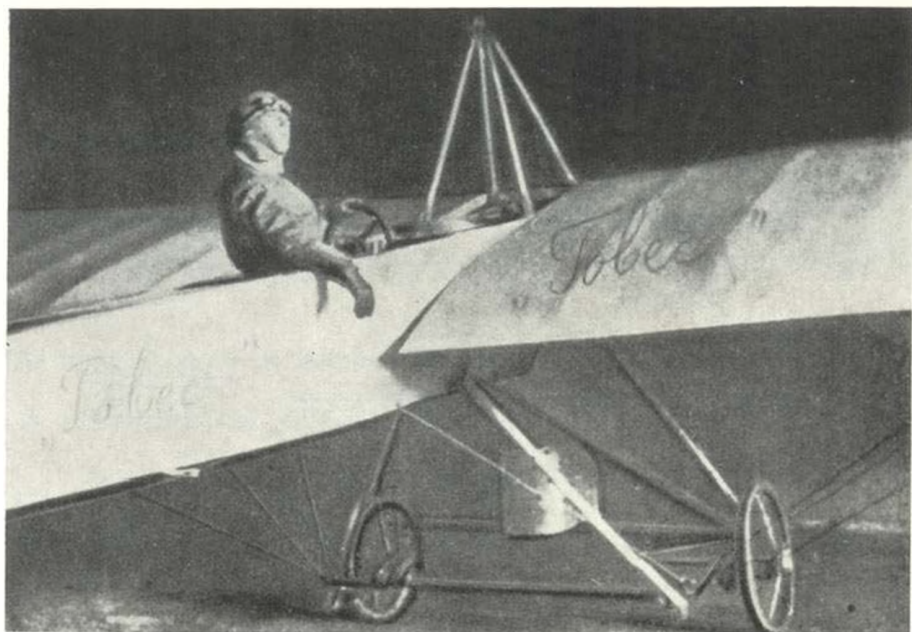

## LĂCUSTA (1911)

Span 9.20 m, length 8.35 m, height 3.20 m.

This plane was designed and built by *Corneliu Marinescu*. Only a few features and performances of the machine are known. Named by its builder *Lăcusta* (Locust), the plane was a three-seater designed as a "bomber." Two seats, for the pilot and observer, were in the fuselage, and the third, for the bomb-aimer, was under the fuselage. Flight tests of the plane were made in 1911 on the airfield of Cotroceni. The pilot was Eugen Komornicki, and according to newspaper reports the plane had good results. Although the performances of the machine were reportedly similar to those of the planes with which the Air Force was equipped at that time, the authorities did not approve its serial construction.



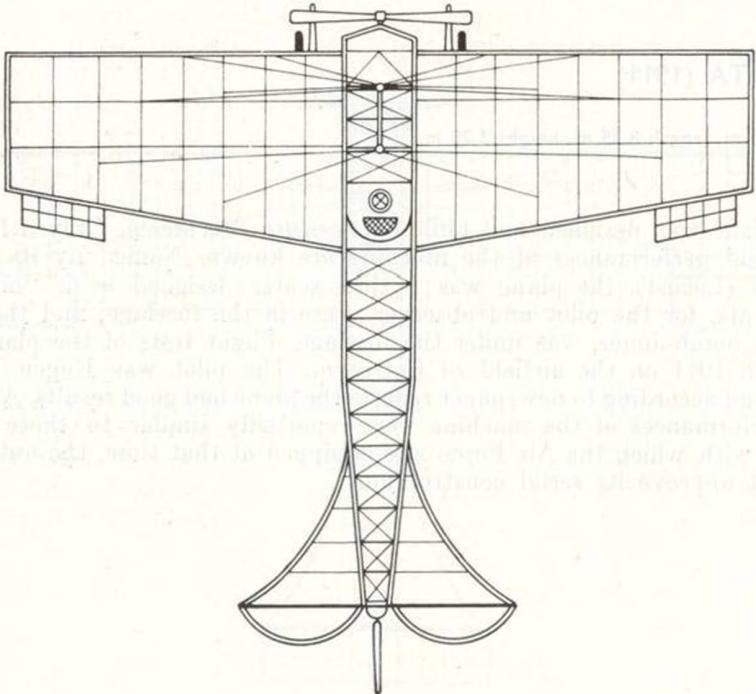
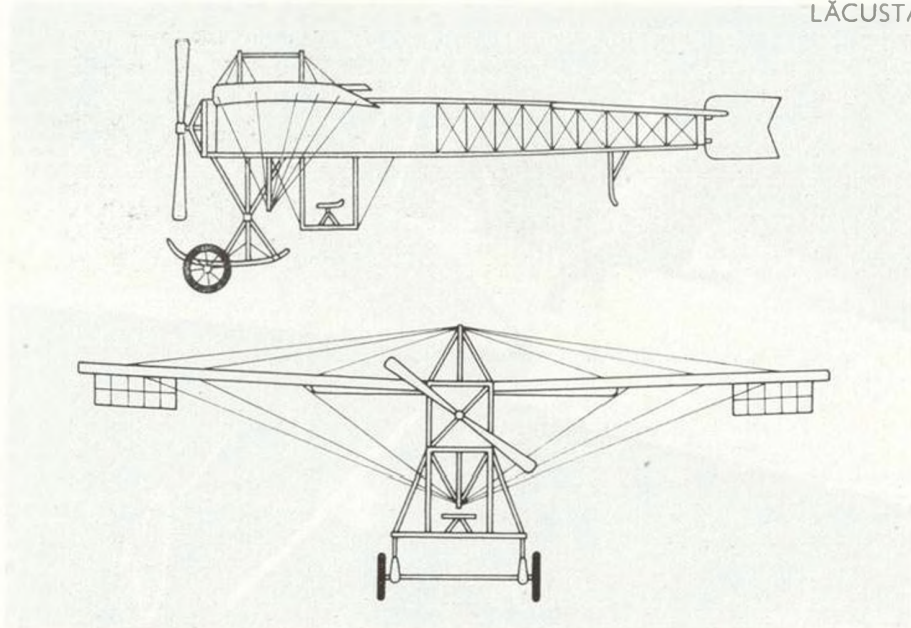

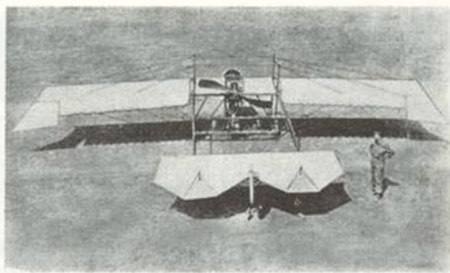

## The ION PAULAT MONOPLANE (1912)

Span 13.00 m, length 9.20 m, wing area 26.00 sq m, weight 250 kg, 50 HP engine.

The building of this one-seater single-engine monoplane began in October 1911 and was completed in May 1912. *Ion Paulat* planned to organize several exhibition flights in order to procure the money he needed to buy the second engine for the flying-boat previously presented in this book.

As stated by the builder himself, the fuselage of the Paulat monoplane was formed of two timber longerons in the higher part, two in the lower part, five lateral longerons and four vertical  $\nu$  struts. This ensemble was fixed by metal clamps with screws and reinforced by cables. The cover was made of cloth. The upper part comprised the pilot's seat and the fuel tank. The landing gear was formed of a metal axle fixed in the lower part of the fuselage, provided with rubber rings, and had two pneumatic wheels. The tail carriage, placed under the rubber, was formed of a bicycle fork with a wheel.

The wing consisted of a central part, affixed to the fuselage, and two lateral mobile surfaces covered with cloth. They were painted and reinforced by metal cables attached to the body of the fuselage. The engine was placed in the lower part, on two  $u$  metal girders. The airscrew, placed between the two upper longerons of the fuselage, was actioned by a chain. After learning to fly his monoplane, Ion Paulat succeeded in effecting several jumps of about 100 m at a height of 2—3 m. After several flights, each being made over a longer distance and at a higher altitude than its predecessor, the machine was damaged on July 6, 1912, when a cylinder of the engine broke and a piece of metal cut one of the sustaining cables of the wing. After this accident Ion Paulat practically ended his activities in aircraft construction.



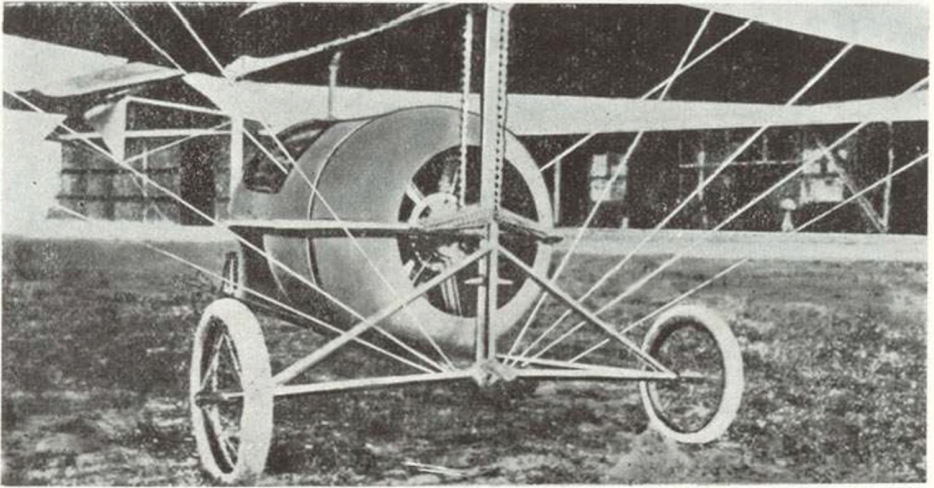

### A. VLAICU Nr. III (1914)

Span 10.00 m, length 10.75 m, height 3.10 m, wing area 24 sq m, 80 HP Gnome engine, rated speed 144 km/h.

The building of this machine, started by *Aurel Vlaicu*, was continued after his death by two of his best friends and co-workers, *Constantin Silișteanu* and *G. Magnani*. The plane was completed in May 1914, and by and large it represented an improved formula of Vlaicu's two machines.

The *A. Vlaicu No. III* was remarkable for its refinement and aerodynamic form, and especially for certain innovations which were not paralleled by other types of planes at the time. One of the remarkable features was the aluminium coverage of the nacelle. Only the wings and the tail unit were covered with cloth.

The nacelle, containing two side-by-side seats, had an aerodynamic form.

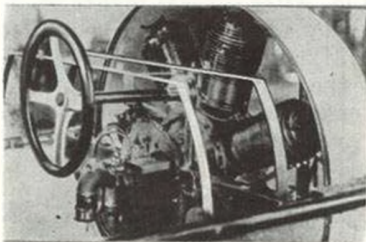

The engine of the *A. Vlaicu No. III* plane.

The engine had a ring hood for better cooling and for the reduction of resistance when advancing. The *A. Vlaicu nr. III* was one of the first aircraft in the world to be equipped with such an engine cowling, which is now currently used for classical air-cooled engines.

During its proving flight, piloted by Captain *Petre Macavei*, one of Romania's best flyers at the time, the plane took off, but had an accident because the pilot, surprised by the unexpectedly rapid ascent, landed abruptly.



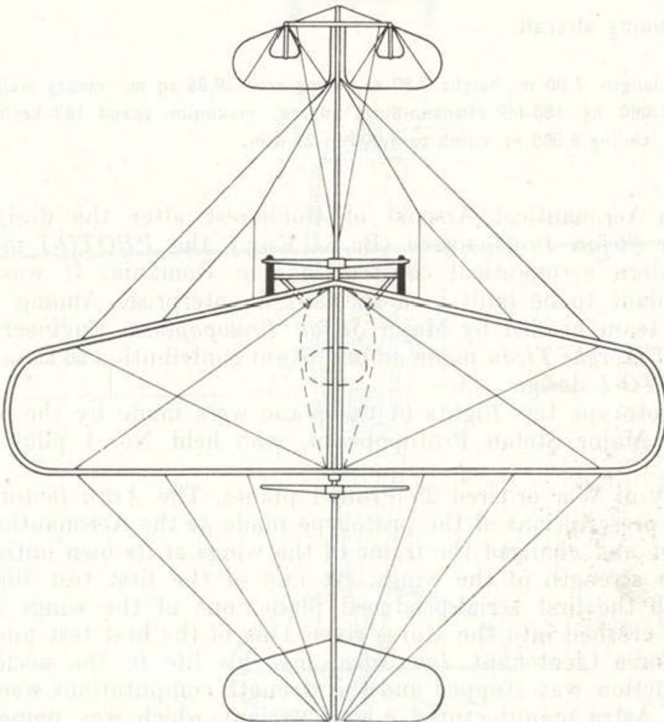
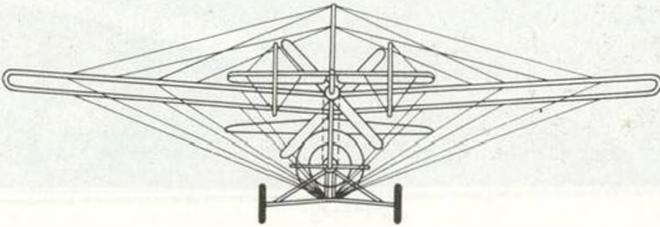
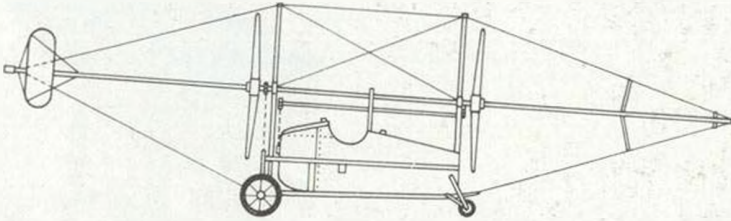

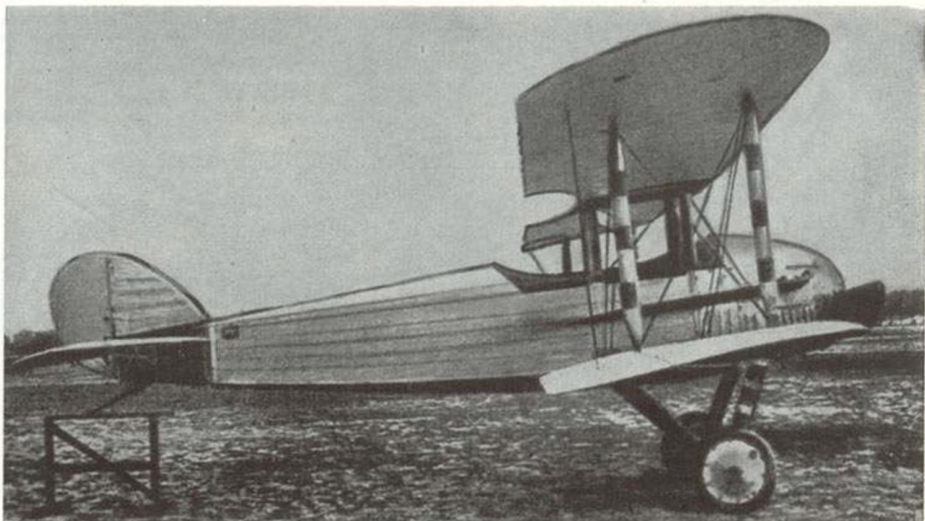

## PROTO-1 (1922)

Advanced training aircraft

Span 9.60 m, length 7.00 m, height 2.90 m, wing area 28.86 sq m, empty weight 670 kg, total weight 1,080 kg, 180-HP Hispano-Suiza engine, maximum speed 183 km/h, minimum speed 81 km/h, ceiling 6,000 m, climb to 4,000 m 29 min.

Built at the Aeronautical Arsenal of Bucharest after the design of Air Force Major *Ștefan Protopopescu* (Bc.S., Eng.), the *PROTO-1* marked the start of modern aeronautical constructions in Romania. It was the first Romanian plane to be built in a specialized enterprise. Among the members of the team headed by Major *Ștefan Protopopescu*, Engineers *Dumitru Baziliu* and *Gheorghe Țicău* made an important contribution to the completion of the *PROTO-1* design.

The first prototype test flights of the plane were made by the designer of the aircraft, Major *Ștefan Protopopescu*, who held No. 1 pilot licence of Romania.

The Ministry of War ordered 25 Proto-1 planes. The *Astra* factory did not respect the prescriptions of the prototype made at the Aeronautical Arsenal of Bucharest and changed the frame of the wings at its own initiative. This reduced the strength of the wings. At one of the first test flights made in 1923 with the first serial-produced plane, one of the wings broke and the aircraft crashed into the Mureș river. One of the best test pilots of that time, Air Force Lieutenant *Ion Sava*, lost his life in the accident.

Serial production was stopped and the strength computations were checked, after which *Astra* manufactured a new variant, which was named *Proto-2*.

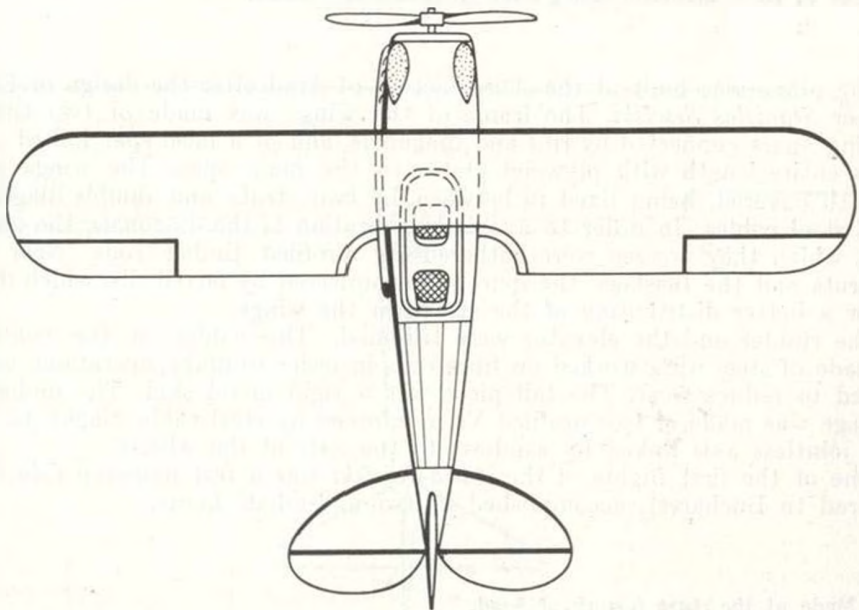
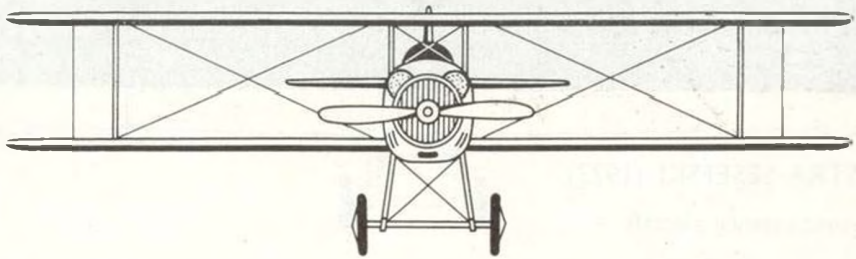
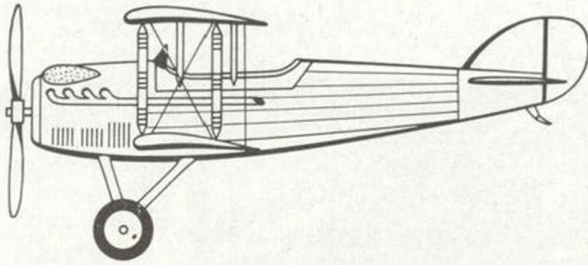





## ASTRA-ŞEŞEFSKI (1923)

Reconnaissance aircraft

Span 12.60 m, length 8.62 m, height 3.12 m, wing area 36.60 sq m, empty weight 1,120 kg, total weight 1,620 kg, 250-HP Martha-Benz \* engine, maximum speed 185 km/h, minimum speed 90 km/h, maximum ceiling 5,500 m, endurance 4 hours.

The plane was built at the *Astra* factory of Arad after the design of Engineer *Stanislas Şeşefski*. The frame of the wings was made of two timber wing spars connected by ribs and diagonals, and of a false spar linked over its entire length with plywood plates to the main spar. The wings were cloth covered, being fixed in between by two struts and double diagonals of steel cables. In order to avoid the vibration of the diagonals, the points at which they crossed were gathered by profiled timber rods. Near the struts and the fuselage, the spars were connected by boxed ribs which made for a better distribution of the stress on the wings.

The rudder and the elevator were trimmed. The cables of the controls, made of steel wire, worked on fibre rolls in order to make operations easier and to reduce wear. The tail piece was a rigid metal skid. The undercarriage was made of two profiled Vs, reinforced by steel cable diagonals, and a jointless axis linked by sandows to the axle of the wheels.

One of the first flights of the *Astra-Şeşefski* was a test non-stop raid from Arad to Bucharest, accomplished in two-and-a-half hours.

\* Made at the *Astra* factory of Arad.

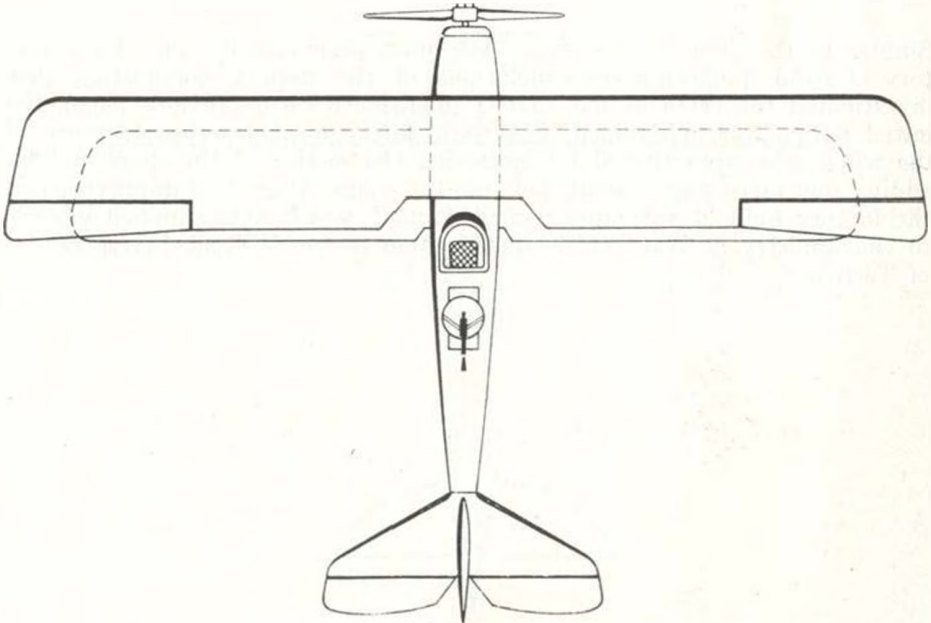
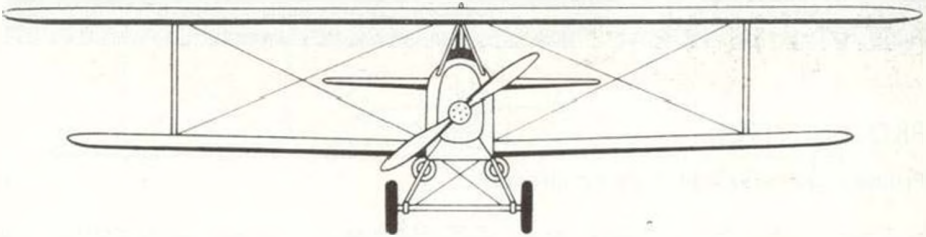
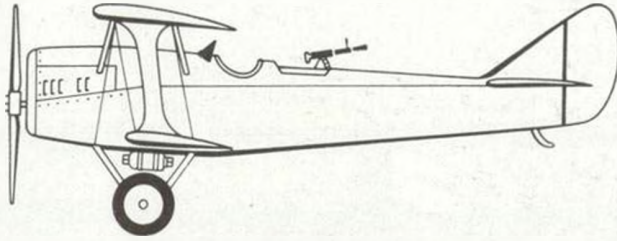

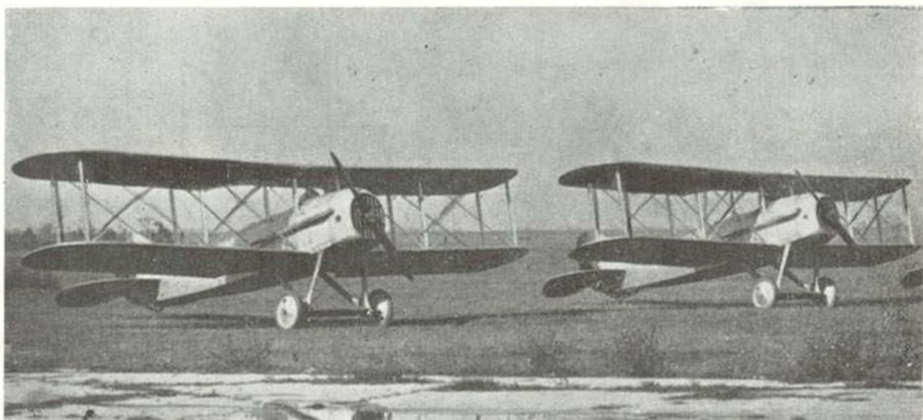

## PROTO-2 (1924)

Primary and advanced training aircraft

Span 9.60 m, length 7.00 m, height 2.90 m, wing area 28.86 sq m, empty weight 730 kg, total weight 1,140 kg, 180-HP Hispano-Suiza engine, maximum speed 174 km/h, minimum speed 79 km/h, maximum ceiling 5,000 m, climb to 3,000 m 22 min.

Similar to the *Proto-1*, this plane was mass-produced by the *Astra* factory of Arad. Following the conclusions of the inquiry commission that investigated the crash of the *Proto-1* (mentioned on a previous page), the initial design was maintained, but as a safety measure, the structure of the wings was strengthened by increasing the section of the spars and by adding one more pair of struts between the wings. After these improvements, the factory built 25 machines named *Proto-2*, which were supplied in 1924 to the Ministry of War, which allotted them to the Military Flying School of Tecuci.



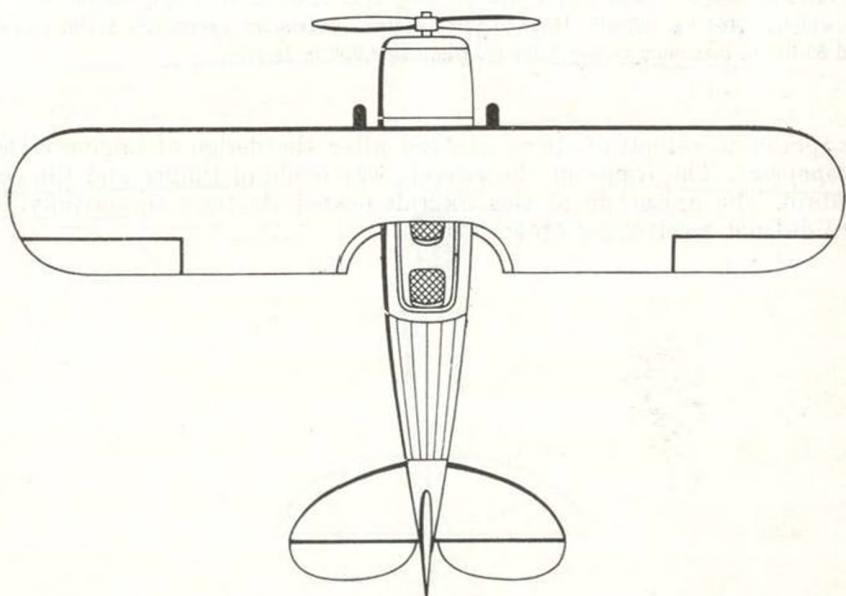
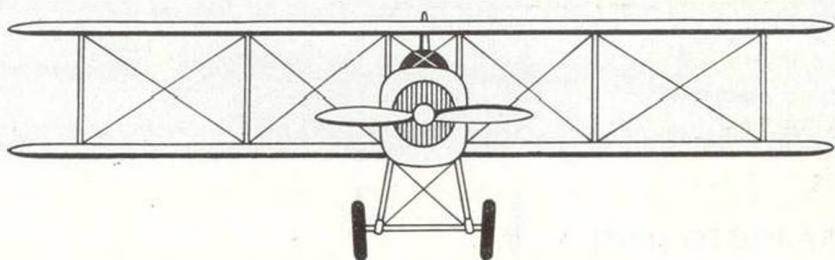
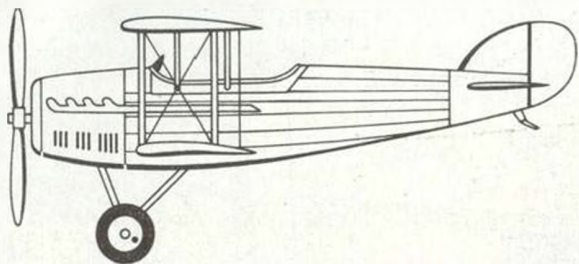

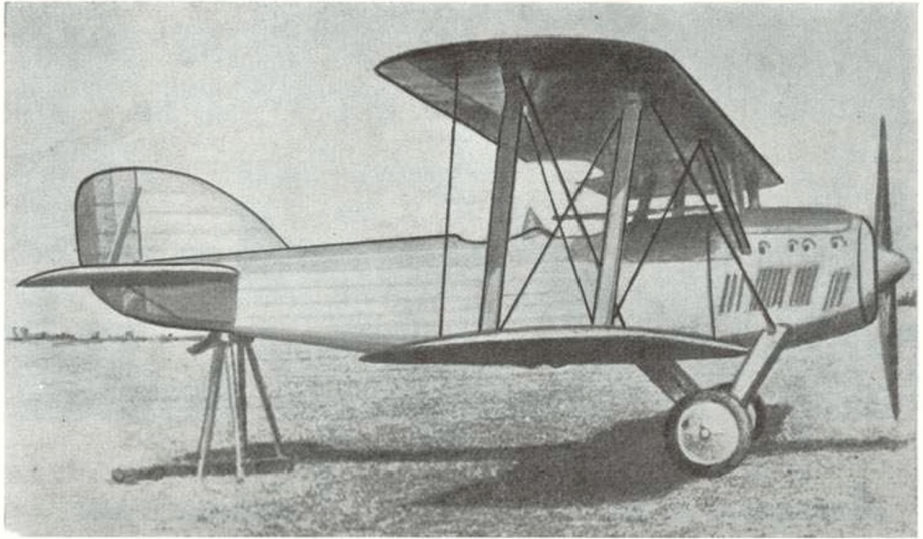

## ASTRA-PROTO (1925)

Reconnaissance aircraft

Span 10.60 m, length 7.20 m, height 2.90 m, wing area 32.00 sq m, empty weight 1,010 kg, total weight 1,488 kg, 300-HP Hispano-Suiza engine, maximum speed 205 km/h, minimum speed 80 km/h, maximum ceiling 5,500 m, climb to 4,000 m 26 min.

This plane was built at *Astra* of Arad after the design of Engineer *Ștefan Protopopescu*. The frame of the aircraft was made of timber and the cover of fabric. The prototype of this aircraft passed its tests successfully, but *Astra* did not receive any orders for it.

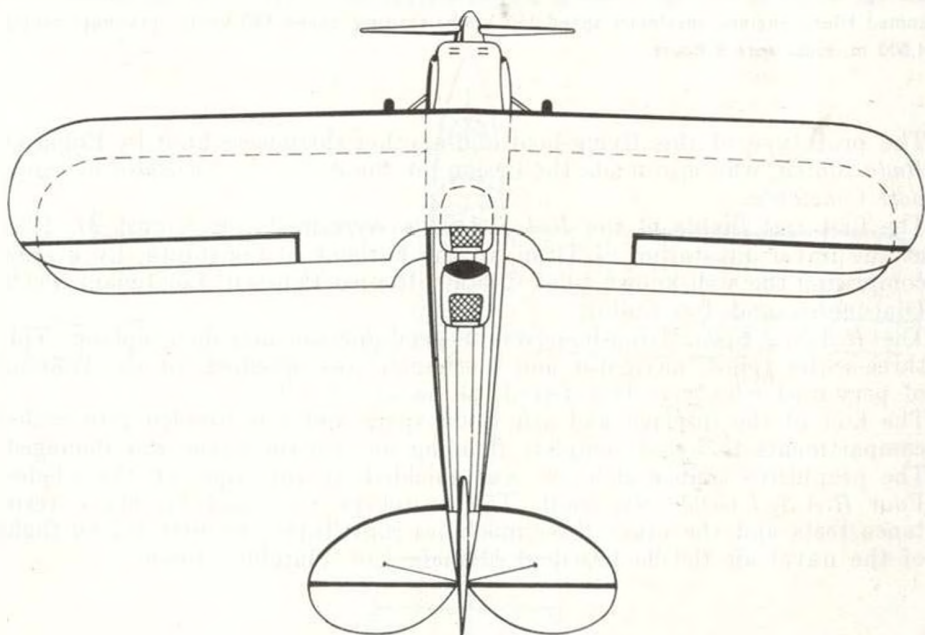
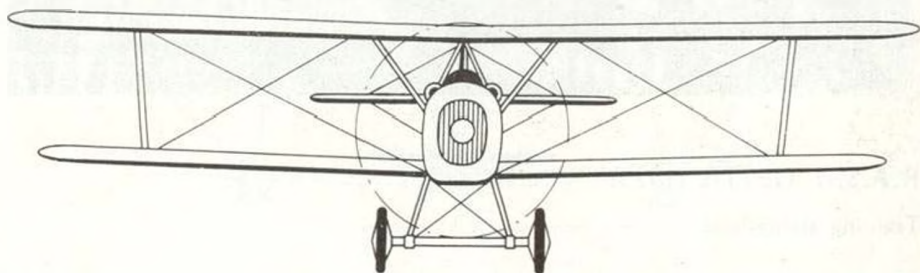
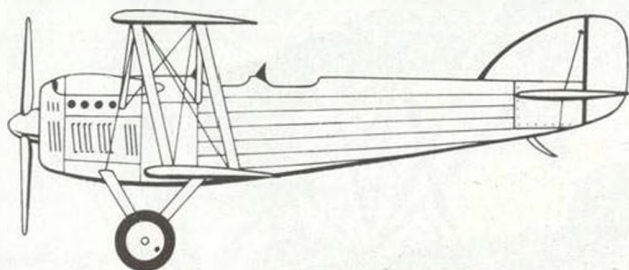





## R.A.S.-1 GETTA (1925)

Training flying-boat

Span 16.00 m, length 10.50 m, height 3.50 m, wing area 50.00 sq.m, weight without engine 825 kg, weight of the engine 420 kg, payload 800 kg, total weight 2,045 kg, 220-HP water cooled Hiero engine, maximum speed 160 km/h, cruising speed 140 km/h, maximum ceiling 4,000 m, endurance 8 hours.

The prototype of this flying-boat and another three were built by Engineer *Radu Stoika*, who also made the design, at the *S.T.C. — Societatea de transport Constanța*.

The first test flights of the *R.A.S.-1 Getta* were made on August 27, 1925 at the naval air station of Titan, in the harbour of Constanța, by a crew comprising the well-known pilot Captain Romeo Popescu, Lieutenant Petre Diaconescu and Ion Culluri.

The *R.A.S.-1 Getta* flying-boat was a pendular unequal-span biplane. This three-seater (pilot, navigator and mechanic) was designed for the training of personnel who were transferred to naval air units.

The hull of the fuselage had ash wood spars and was divided into sealed compartments to avoid complete flooding in case the cover was damaged. The propulsive timber airscrew was shielded at the tips of the blades. Four *R.A.S.-1 Getta* were built. The prototype was used for static resistance tests and the other three machines constituted the first school flight of the naval air flotilla based at Mamaia, on Siutghiol Lake.

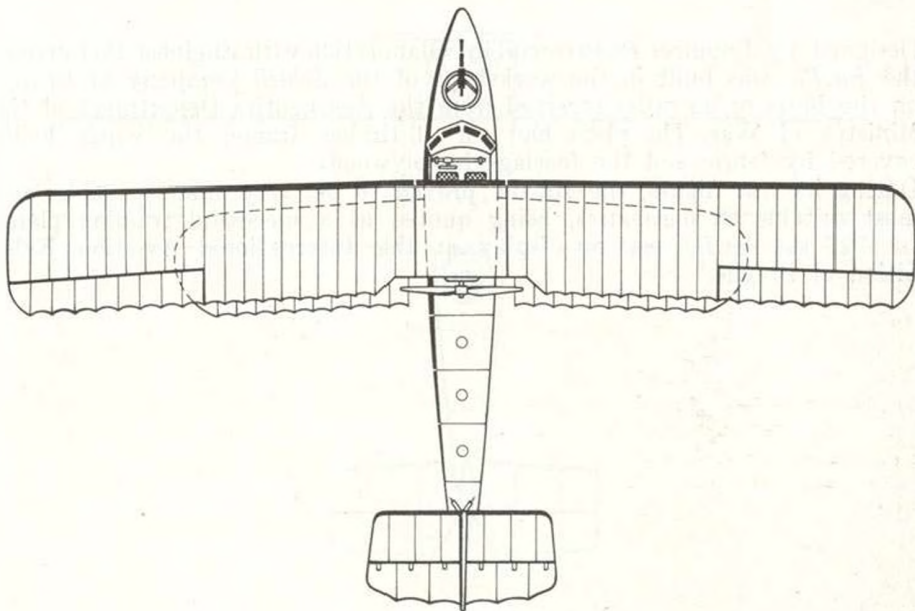
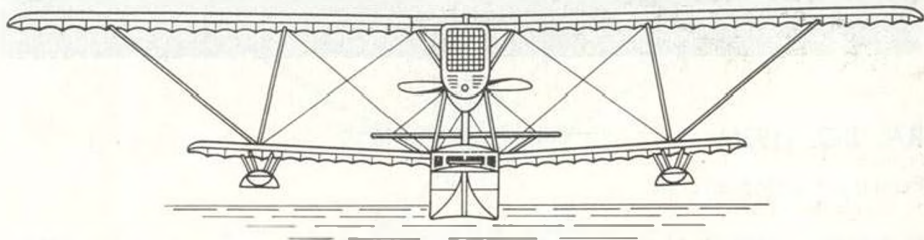
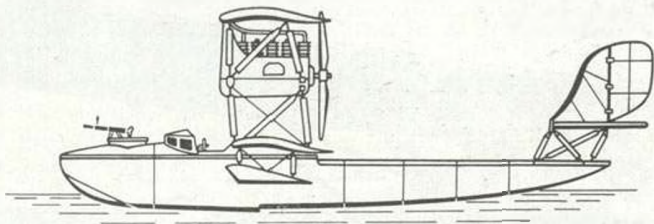

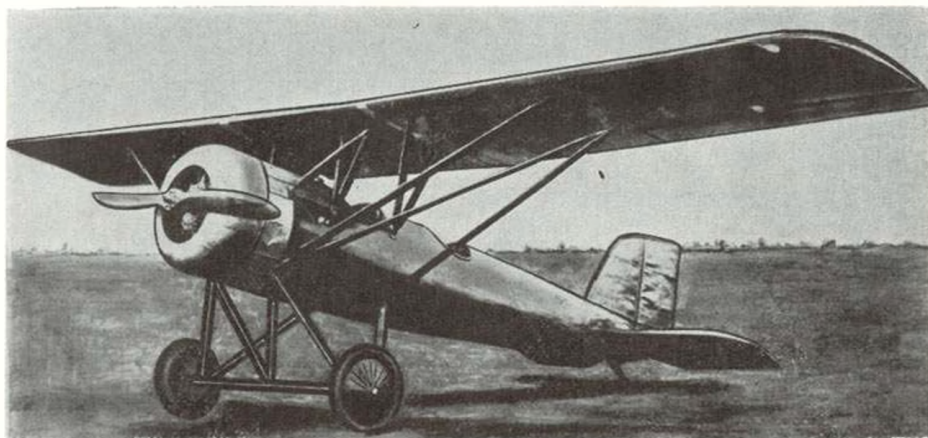

## RA. BO. (1926)

Primary training aircraft

Span 10.00 m, length 6.12 m, height 2.60 m, wing area 15.00 sq m, empty weight 525 kg, total weight 735 kg, 80-HP (rotary) Rhône engine, maximum speed 145 km/h, minimum speed 95 km/h, climb to 1,000 m 5 min, maximum range 470 km, endurance 3 h 30 min.

Designed by Engineer *Radu Onciul* in collaboration with Engineer *Bo Carlson*, the *Ra.Bo.* was built in the workshops of the *Schiell* Company of Braşov on the basis of an order received from the Aeronautics Department of the Ministry of War. The plane had an all-timber frame, the wings being covered by fabric and the fuselage by plywood.

During its test flights, the *Ra.Bo.* proved to be very manoeuvrable and most suitable for aerobatics, being quoted as a successful training plane. In 1927 the *Ra.Bo.* was on display at the International Aviation Exhibition of Prague.



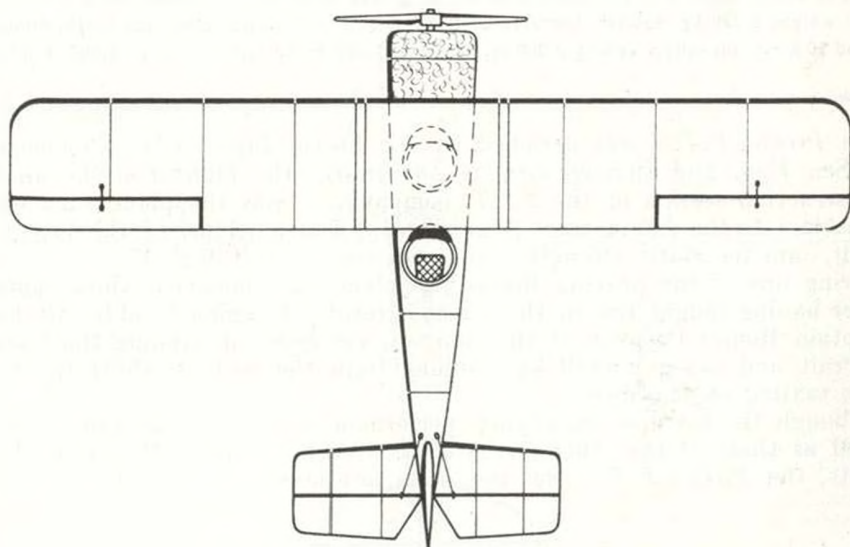
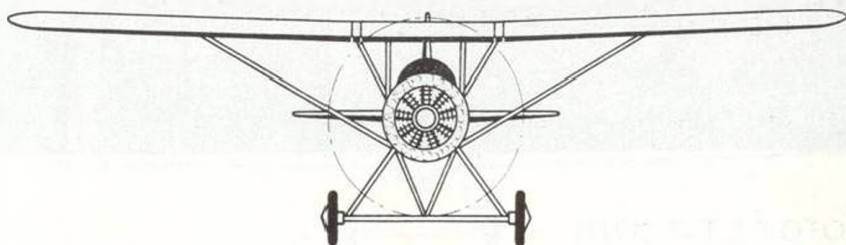
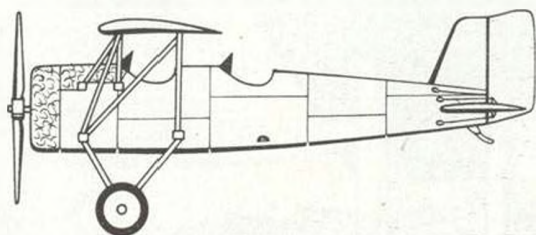

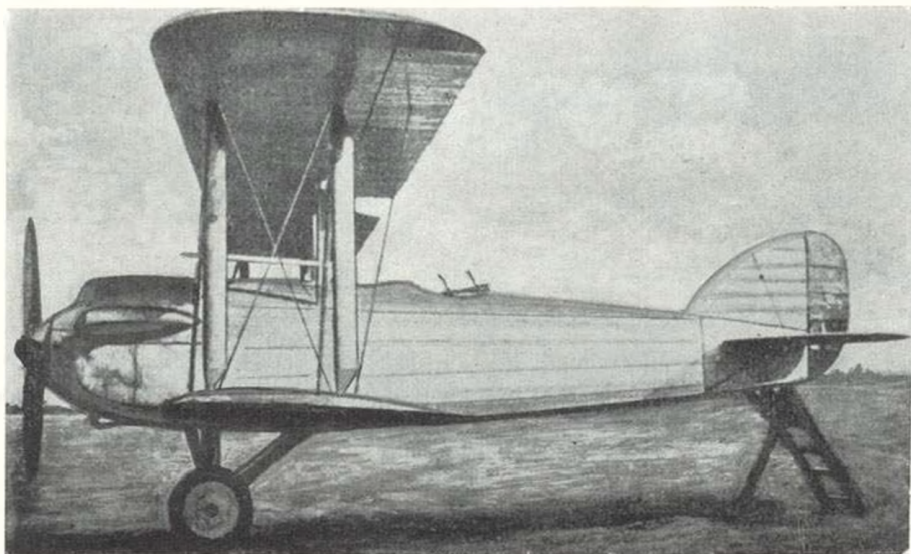

## PROTO-S.E.T.-2 (1927)

Reconnaissance aircraft

Span 13.40 m, length 8.60 m, height 3.40 m, wing area 45.00 sq. m, empty weight 1,220 kg, total weight 2,020 kg, 450-HP Lorraine-Dietrich engine, maximum speed 222 km/h, minimum speed 90 km/h, maximum ceiling 7,000 m, climb to 3,000 m 10 min, climb to 5,000 m 29 min.

The *Proto-S.E.T.-2* was designed by Air Force Major *Ștefan Protopopescu* (B.Sc., Eng.) and Engineer *Grigore Zamfirescu*, the founder of the aircraft construction section of the *S.E.T.* company. It was the plane with whose construction the section started its activity. Two machines of this type were built, one for static strength tests and one for test flights.

During one of the proving flights the plane was damaged whilst landing, after having caught fire in the air as a result of engine trouble. Air Force Captain Romeo Popescu, at the controls, succeeded in landing the burning aircraft and saved himself by jumping from the cockpit whilst the plane was taxiing on the field.

Although the features and flying performances of this aircraft were as good as those of the other planes of its kind in service with our Air Force units, the *Proto-S.E.T.-2* was not mass produced.

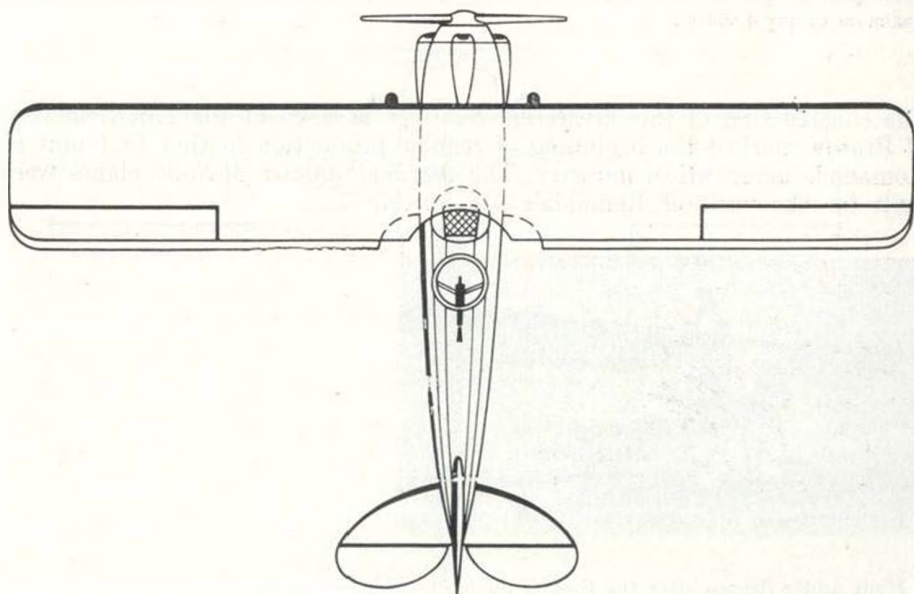
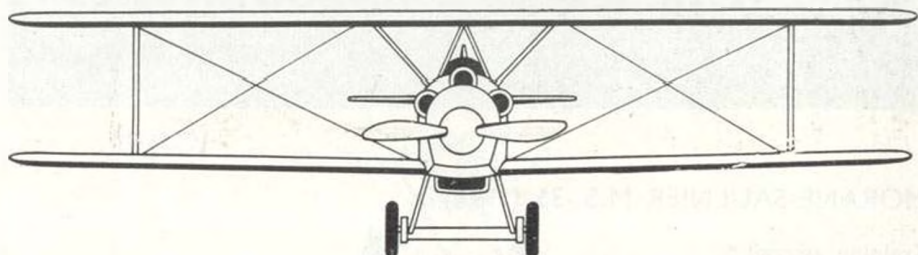
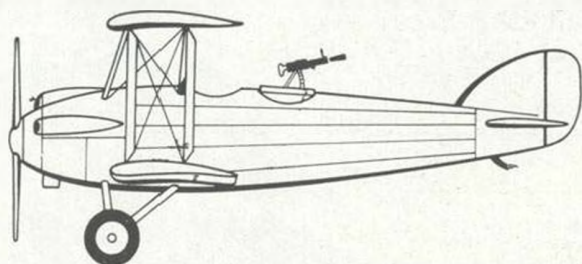



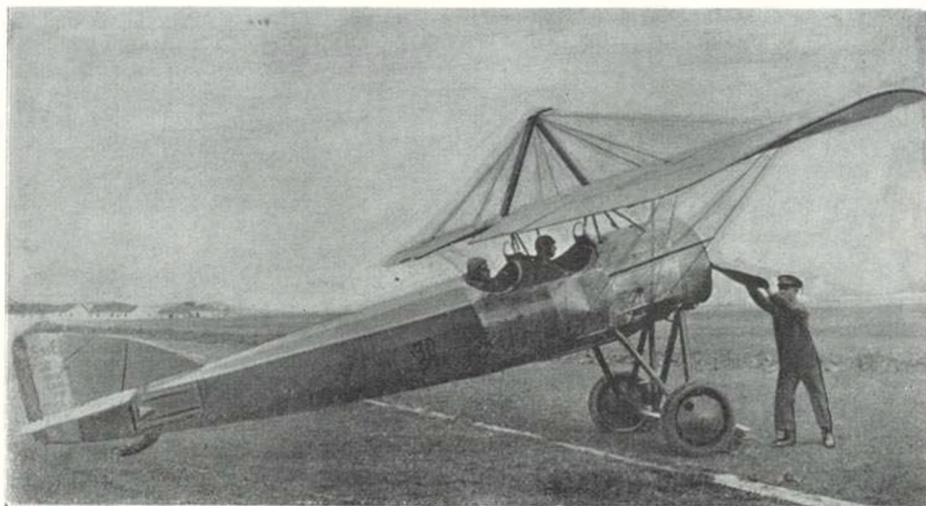

## MORANE-SAULNIER M.S.-35 (1928)

Training aircraft \*

Span 10.57 m, length 6.77 m, height 3.61 m, empty weight 450 kg, total weight 700 kg, 80-HP (rotary) Gnôme-Rhône engine, maximum speed 135 km/h, speed at 2,000 m 125 km/h, maximum ceiling 4,600 m.

The construction of the 30 *Morane-Saulnier M.S.-35* at the *I.A.R.* factory of Braşov marked the beginning of regular production in that first unit of Romania's aeronautical industry. The *Morane-Saulnier M.S.-35* planes were built for the units of Romania's Air Force.



\* Built under licence after the French plane of the same name.

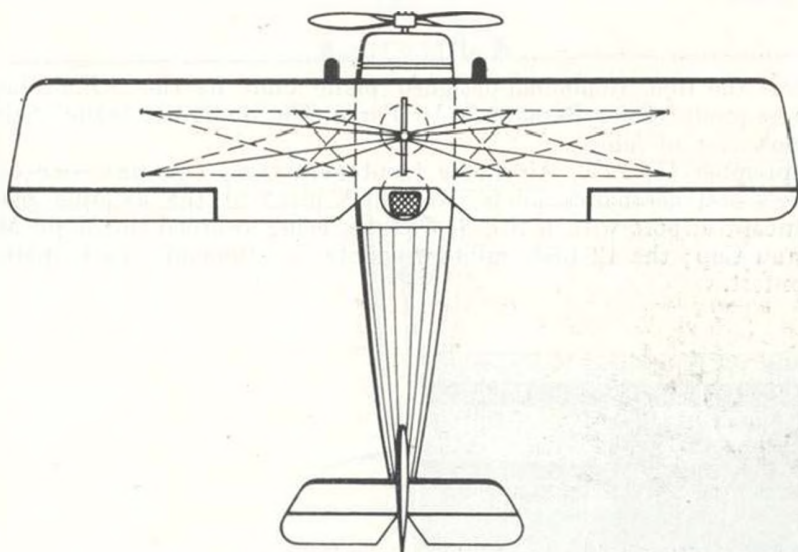
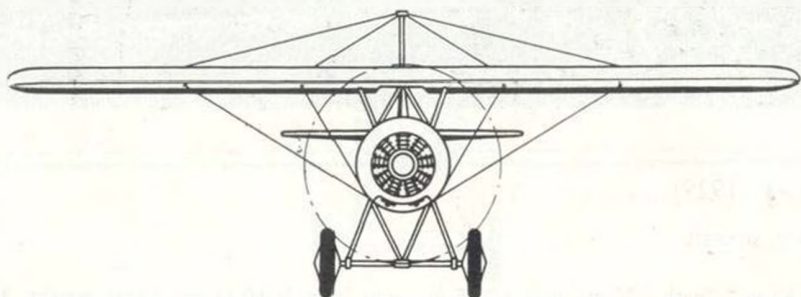
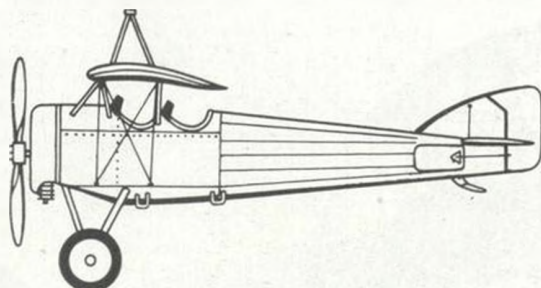

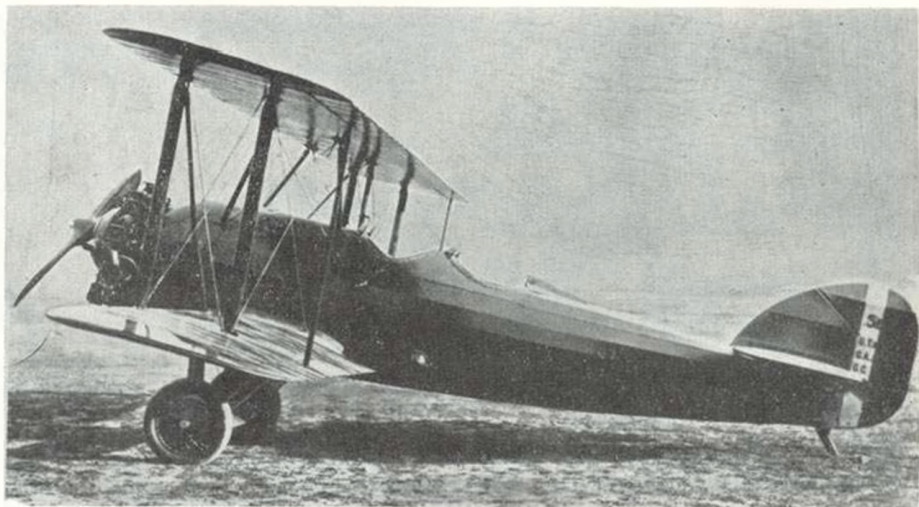

### S.E.T.-3 (1929)

Training aircraft

Span 9.80 m, length 7.20 m, height 3.15 m, wing area 26.60 sq m, empty weight 826 kg, total weight 1,120 kg, 230-HP Salmson 9 Ab engine, maximum speed 215 km/h, speed at 2,000 m, 191 km/h, minimum speed 80 km/h, climb to 2,000 m 5 min 4 sec, climb to 4,000 m 11 min 50 sec.

This was the first Romanian-designed plane built by the *S.E.T.* factory and mass-produced for Romania's Air Force. The frame was made of timber and the cover of fabric.

On September 14, 1930, Air Force Lieutenant *Octav Oculeanu*, one of this country's best aerobatics pilots, won first place at the aviation meeting on Băneasa airport with a *S.E.T.-3* plane, being awarded the Major *Mircea Zorileanu* Cup; the 12 best military pilots of Romania participated in the contest.





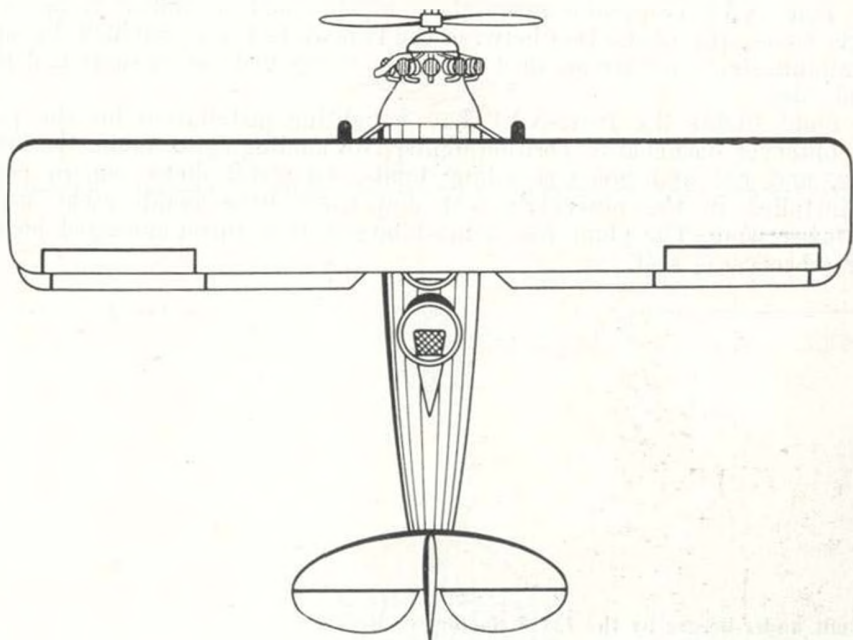
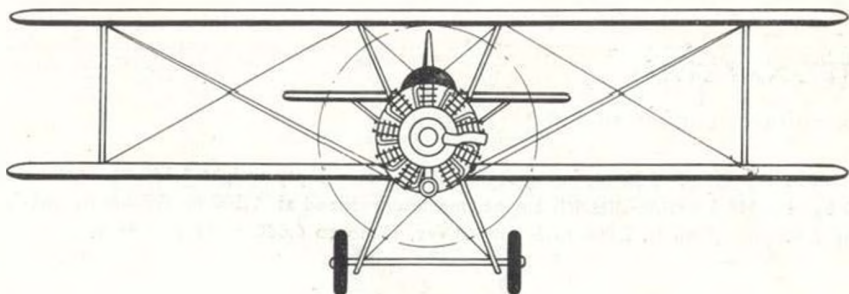
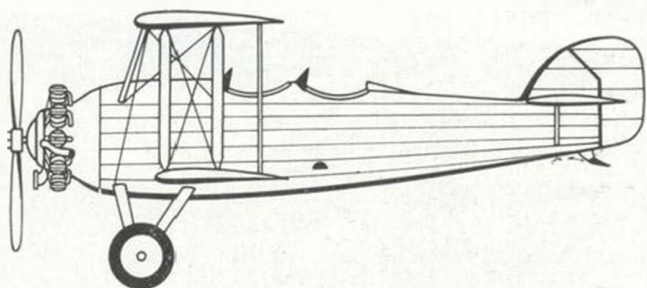



## POTEZ-XXV (1929)

Reconnaissance-bomber aircraft \*

Span 14.02 m, length 9.20 m, wing area 47.00 sq m, empty weight 1,370 kg, total weight 1,960 kg, 450-HP Lorraine-Dietrich engine, maximum speed at 1,500 m 217 km/h, maximum ceiling 7,400 m, climb to 2,000 m 6 min 48 sec, climb to 6,000 m 29 min 46 sec.

The *Potez-XXV* two-seater sesquiplane biplane had a timber frame and fabric cover, the connection between the two wings being provided by duraluminium struts and streamlined wires. The wings had timber spars and plywood ribs.

For night flights the *Potez-XXV* had a lighting installation for the pilot and observer dashboards, position lights, two landing lights under the lower wing, and red and green signalling lights. An aerial photo camera could be installed in the observer's seat and there were bomb racks under the lower wing. The plane had a machine-gun in a turret mounted on the rear (observer's) seat.

\* Built under licence by the *I.A.R.* factory of Braşov.

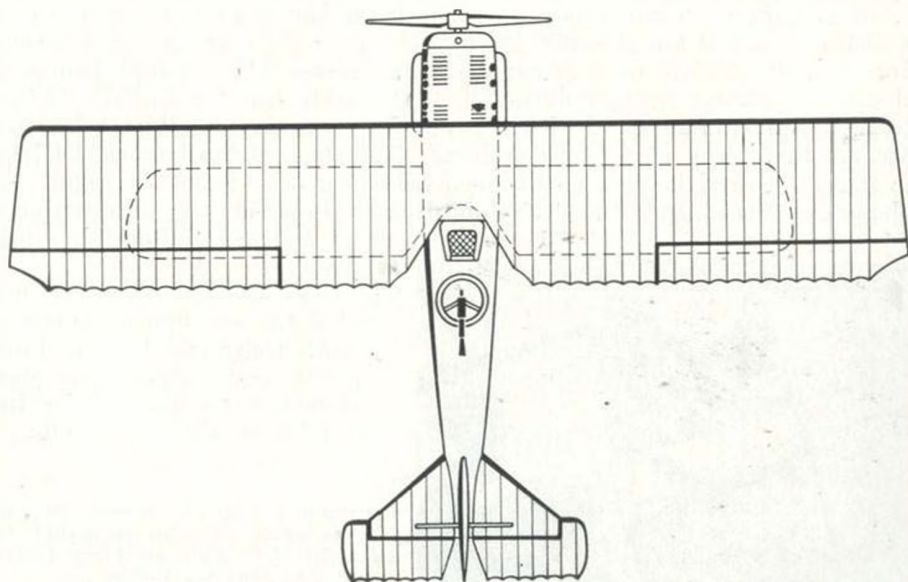
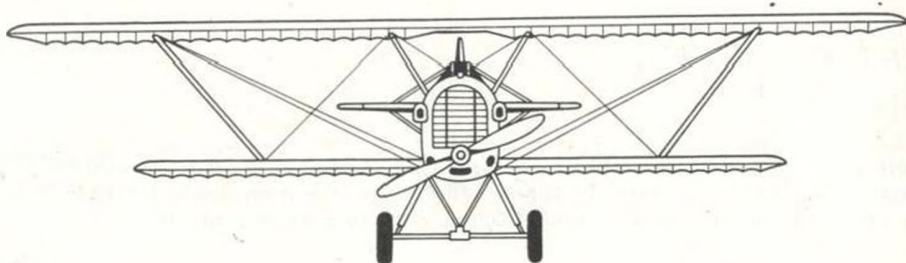
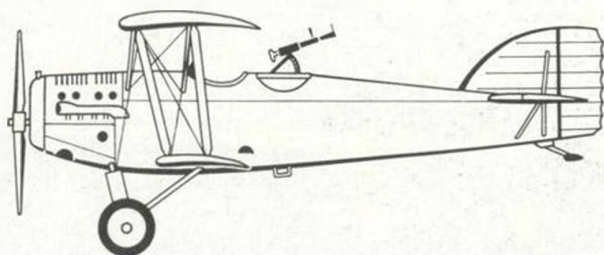



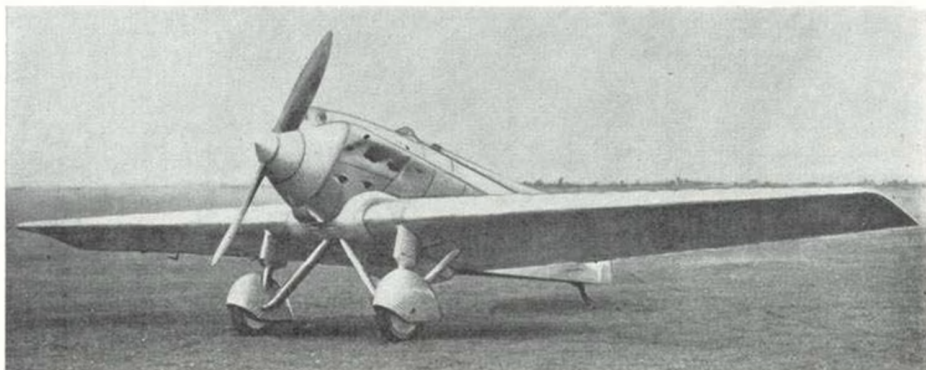

## I.A.R.-C.V. 11 (1930)

Fighter aircraft

Span 11.50 m, length 6.98 m, height 2.46 m, wing area 19.80 sq m, empty weight 1,100 kg total weight 1,510 kg, 600-HP Lorraine-Courlis engine, maximum speed 329 km/h, speed at 5,000 m 302 km/h, maximum ceiling 9,000 m, climb to 5,000 m 8 min 30 sec.

This was the first Romanian plane built by *I.A.R.* of Braşov after a design by Engineer *Elie Carafoli* and the French Engineer *Virmoux*. On December 9, 1931, Captain *Romeo Popescu* tried to break the world speed record over a distance of 500 km (306.696 km/h), set up in 1924 by the French pilot *Joseph-Sadi-Lecointe* on a *Nieuport-Delage* plane. The attempt had good chances of success because during its test flights the *I.A.R.-C.V. 11* had reached a maximum speed of 329 km/h. However Captain *Romeo Popescu* became the victim of a tragic accident. Following engine trouble, he tried to make a forced landing on an open field near the village of *Lehliu*. The plane overturned and killed Captain *Romeo Popescu*, an excellent test pilot and one of Romania's best flyers.

In 1930, the *I.A.R.-C.V. 11* was one of the best fighting planes as regards design and flying performance. A new variant was planned, but it was never built after the fatal accident of *Lehliu*.



Air Force Captain *Romeo Popescu* before taking off on his last flight in the *I.A.R.-C.V. 11* with Air Force Lieutenant *Gheorghe Ştefănescu*.

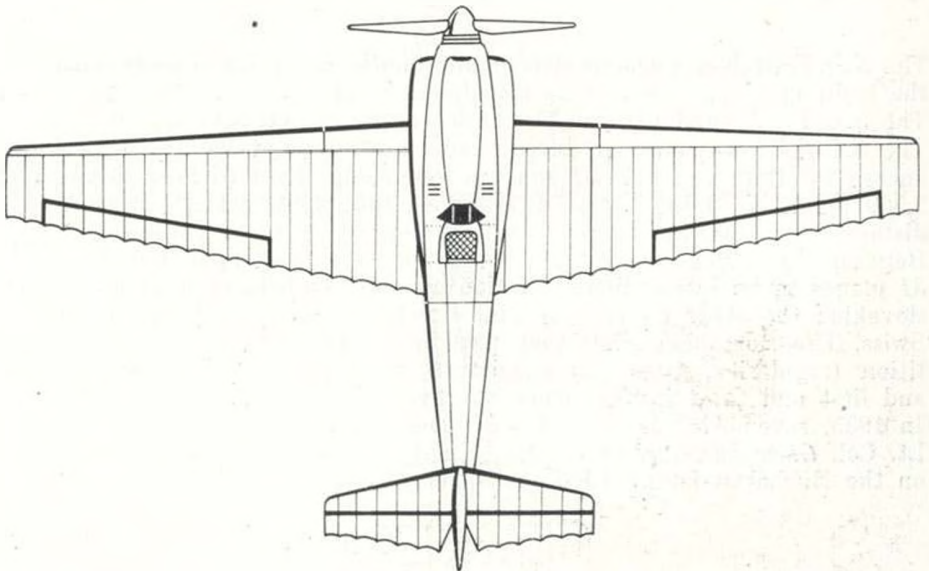
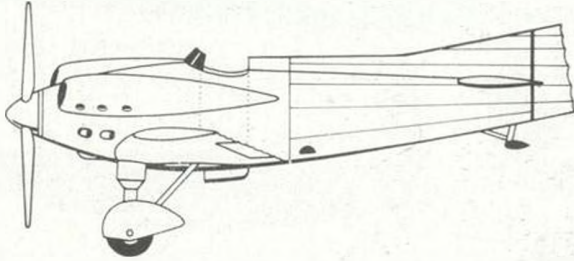



### S.E.T.-31 (1930)

Training and liaison aircraft

Span 9.80 m, length 7.20 m, height 3.15 m, wing area 26.60 sq m, empty weight 826 kg, total weight 1,120 kg, 230 HP Salmson 9 Ab engine, maximum speed 215 km/h, speed at 2,000 m 198 km/h, minimum speed 80 km/h, maximum ceiling 6,000 m, climb to 2,000 m 6 min 20 sec, endurance 2 hours 54 min, take-off run 85 m, landing run 160 m.

The *S.E.T.-31* had a timber frame and fabric cover. It was designed for the training of pilots who were transferred from training to fighting planes. The *S.E.T.-31* could perform the entire range of aerobatic figures.

The *S.E.T.-31* was mass-produced, and set up several remarkable performances. In 1931 a *S.E.T.-31* made a long-range flight to Poland, covering 2,300 km in 11 flying hours. In 1933 a plane of the same type covered a distance of 18,000 km on a route including 13 towns of Europe.

Between May 1 and 4, 1931, three Romanian crews participated with *S.E.T.-31* planes in an international aviation competition held at Plzen in Czechoslovakia; the other crews were nine Czechoslovak, three German and one Swiss. The Romanian pilots took part in all the three tests of the competition (regularity, speed and aerobatics), placing first in the team ranking and first and third in the general individual rankings.

In 1935, seven Air Force *S.E.T.-31* planes under the command of Air Force Lt. Col. *Gheorghe Negrescu* (B. Sc., Eng.) carried out a flight in formation on the Bucharest-Istanbul-Eskisheir-Ankara-Bucharest route.



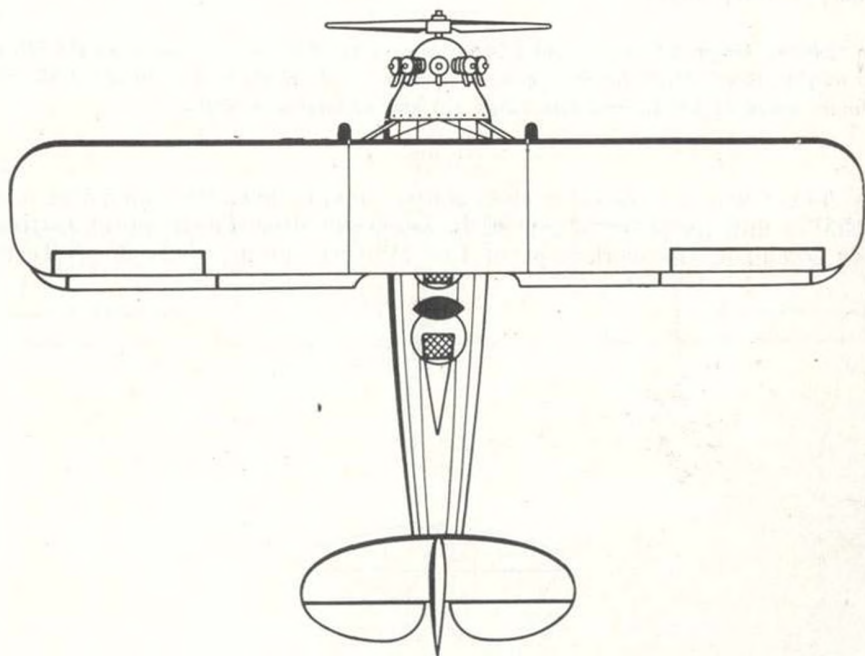
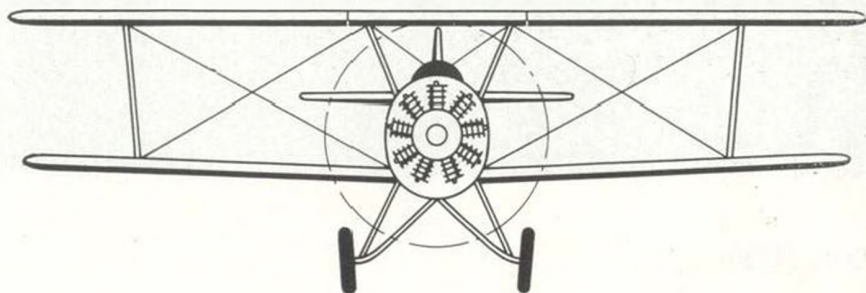
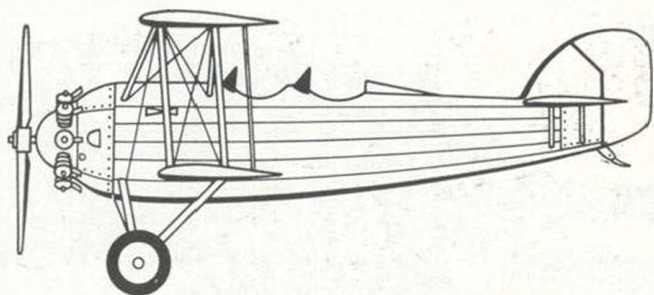



### R.O.-1 (1930)

Primary training aircraft

Span 12.00 m, length 6.12 m, height 2.20 m, wing area 18.00 sq. m, empty weight 360 kg, total weight 550 kg, 35-HP Anzani engine, maximum speed 125 km/h, cruising speed 95 km/h, minimum speed 65 km/h, maximum range 380 km, endurance 4 hours.

The *R.O.-1* was a two-seater dual-control monoplane. Its frame was made of timber and its cover of fabric. It was built after the design of Engineer *Radu Onciul* in the workshops of the Military Flying School of Tecuci.

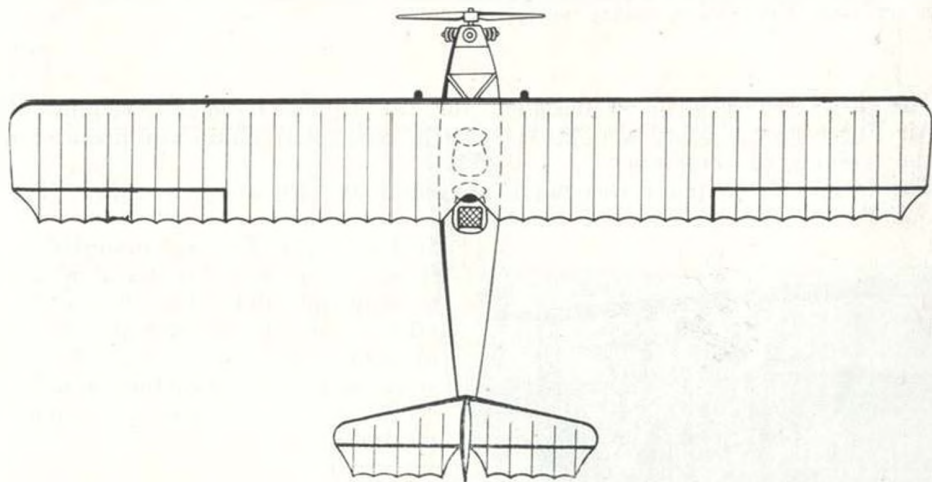
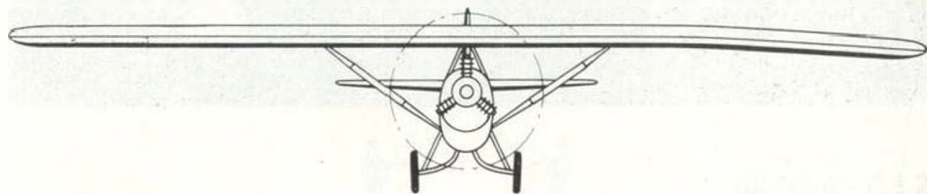
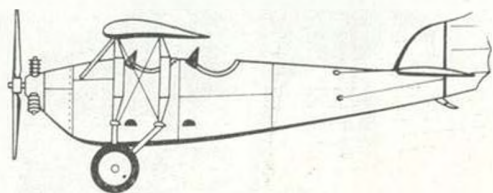



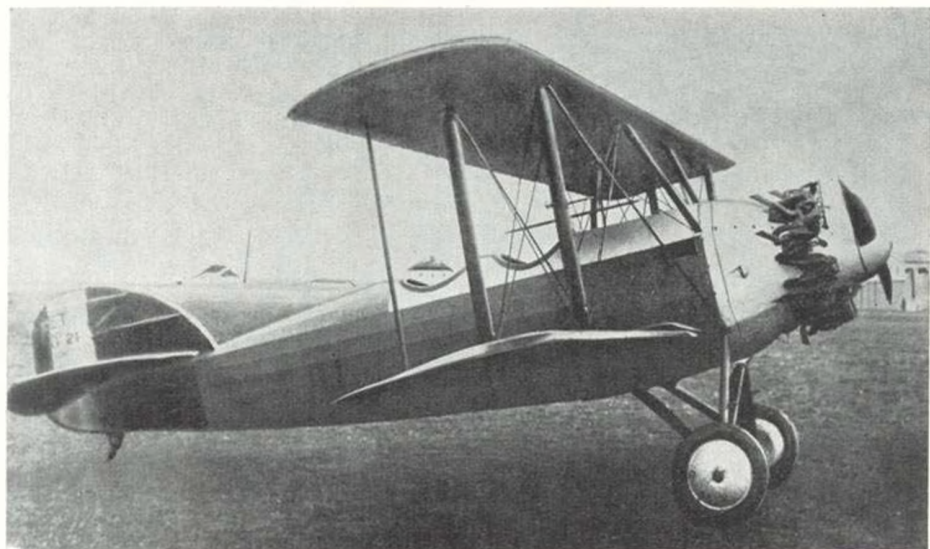

### S.E.T.-7 (1930)

Advanced training aircraft

Span 9.80 m, length 7.30 m, height 3.15 m, wing area 26.60 sq m, empty weight 912 kg, total weight 1,310 kg, 365-HP Jaguar engine, maximum speed 240 km/h, speed at 2,000 m, 235 km/h, maximum ceiling 6,200 m, climb to 2,000 m 3 min 40 sec, climb to 5,000 m 15 min 30 sec, take-off run 200 m, landing run 130 m.

The *S.E.T.-7* was a plane designed for the squadron phase training of Air Force crews, being also provided with radio and photo equipment for the training of observers.

The frame of the plane was made of timber and the cover of fabric. The *S.E.T.-7* was mass-produced for the Air Force units.



In 1931 a *S.E.T.-7* was mounted on floats to be used for the training of seaplane pilots. The change was effected in the workshops of the Mamaia naval air station. The results were not satisfactory and the seaplane variant was not mass-produced.

The seaplane variant of the *S.E.T.-7*,

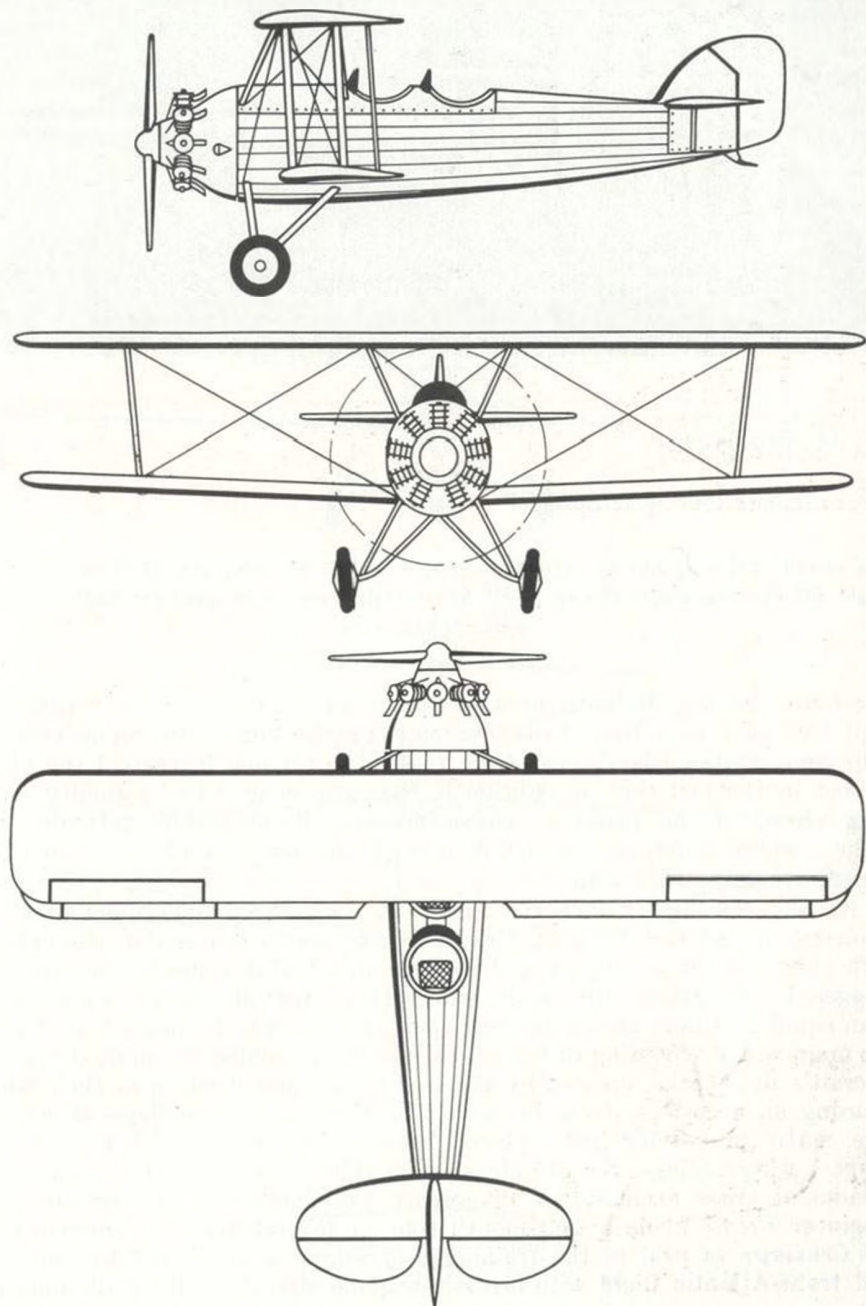

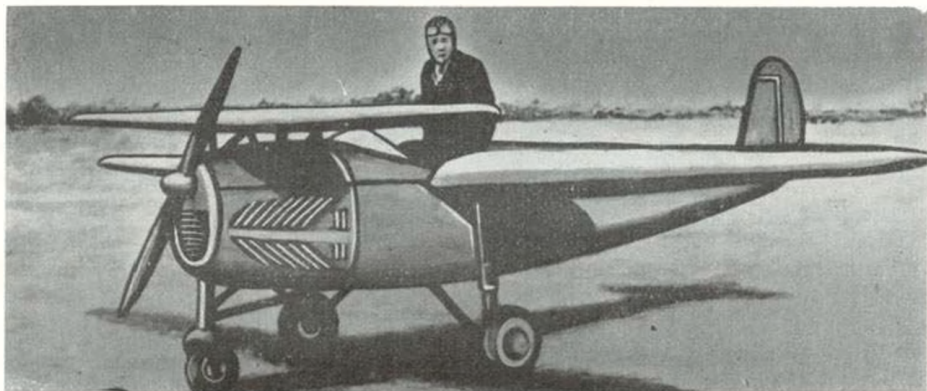

## CRUISAIRE (1930)

Aerobatics and touring aeroplane

Span of the front wing 3.81 m, span of the main wing 7.26 m, wing area 36.56 sq m, empty weight 397 kg, total weight 600 kg, 75-HP Rover engine, maximum speed 136 km/h.

The *Cruisaire* was designed by the Romanian Engineer *George Fernic* and built by the *Fernic Aircraft Corporation*, set up by him at Richmond Terrace, Arlington, Staten Island, near New York. The original feature of the plane resided in the fact that in addition to the main wing it had a smaller front wing ahead of the fuselage, which increased flying stability. It also had a three-wheel undercarriage, being one of the few aircraft with such an undercarriage at that time.

In its issue for June 1930, the *American Aero Digest* underlined that the tandem-wing aircraft built by *George Fernic* was a two-seater monoplane, with the upper wing in a parasol position ahead of the cockpit and entirely staggered as against the main wing. This forward (upper) wing had a span equal to  $1/2$  of the main wing span and an area of some  $1/4$  of that of the main wing. According to *Fernic*, this formula avoided the normal tandem aircraft's drawbacks, created by the equal span and position of their wings (causing an excessive stress in certain sections of the fuselage structure). The centre of gravity being placed between the wings, with the forward (upper) wing taking over the air impact effect ahead of the main wing, a moment arises excluding a divergence possibility of the aircraft.

Engineer *Fernic* made a four-month tour in several parts of America with his *Cruisaire* as part of the training programme with a view to the planned trans-Atlantic flight with his twin-engined aircraft built for the purpose.



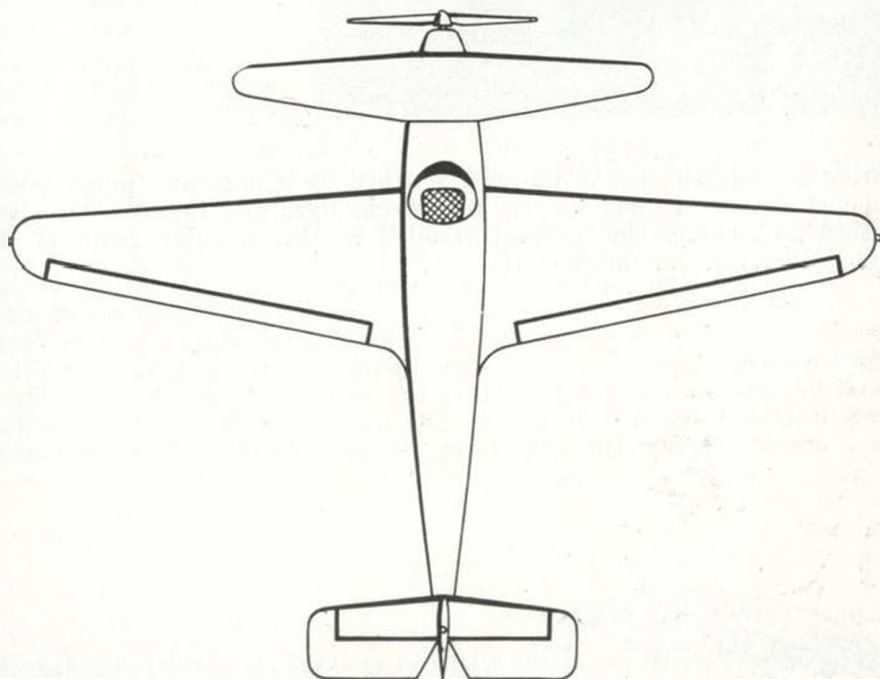
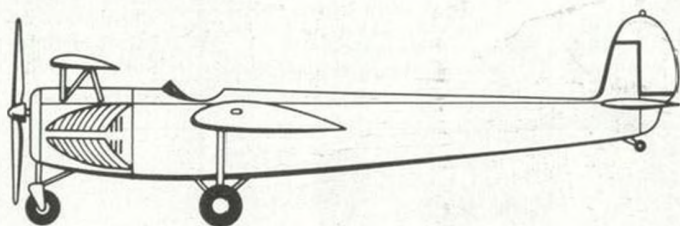

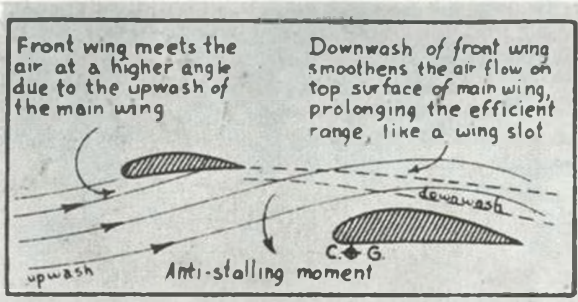

Aerodynamic action of Feric wings

Drawing in the review *Aero Digest*, published in order to illustrate the aerodynamic effect of the Feric wings of the *Cruisair*.

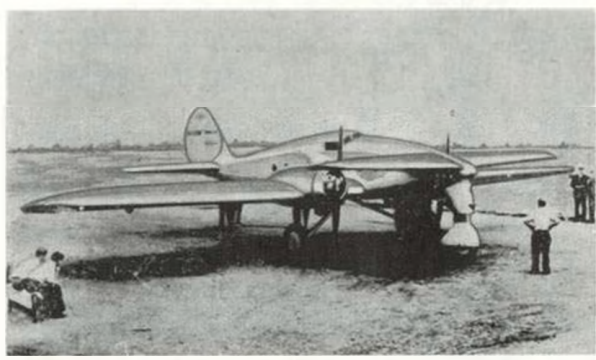

The twin-engined aircraft designed and built by George Feric.

During a demonstration in Chicago, watched by a numerous public which included the world famous flyers Lindbergh, Byrd and Bellonte, his plane crashed on landing. The accident resulted in the untimely death of the young Romanian aircraft builder.



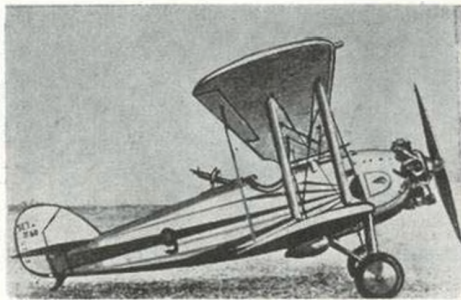

## S.E.T.-4 AND S.E.T.-41 (1931—1932)

Training aircraft for night and blind flying

Span 9.80 m, wing area 26.60 sq m. *S.E.T.-4* variant: empty weight 812 kg, total weight 1,200 kg, 230-HP Salmson 9 Ab engine, maximum speed 210 km/h, speed at 2,000 m 198 km/h, minimum speed 82 km/h, maximum ceiling 5,000 m, climb to 2,000 m 6 min. 55 sec, climb to 5,000 m 26 min. *S.E.T.-41* variant: empty weight 868 kg, total weight 1,322 kg, 380-HP Gnôme-Rhône 7K engine, maximum speed 202 km/h, speed at 2,000 m 191 km/h, minimum speed 87 km/h, maximum ceiling 5,800 m, climb to 2,000 m 9 min 25 sec, climb to 5,000 m 42 min.

Both variants had a similar timber and metal mixed structure and were covered with fabric. The *S.E.T.-41* was specially equipped for night flying (having the necessary devices, radio, electric system for lighting and heating, flare bombs etc.) and an air camera.

The armament comprised a *Vickers* machine-gun firing through the airscrew and two *Lewis* machine-guns in a turret in the observer's seat. Under the lower wing the *S.E.T.-41* had two *I.A.R.-Barbieri* bomb racks for six 12-kg bombs each.

Air Force Major *Gheorghe Bănciulescu*, the first flyer in the world who piloted with artificial legs, \* carried out a lightning long distance flight in 1933 (8,000 km in 9 days) on board a *S.E.T.-41* over the distance Bucharest - Belgrade - Zagreb - Venice - Milan - Marseille - Barcelona - Madrid - Bordeaux - Paris - London - Strassbourg - Prague - Vienna - Belgrade - Bucharest.

\* *Gheorghe Bănciulescu's* legs had to be amputated after a very serious aviation accident he had in 1927 in the Tatra Mountains of Czechoslovakia.



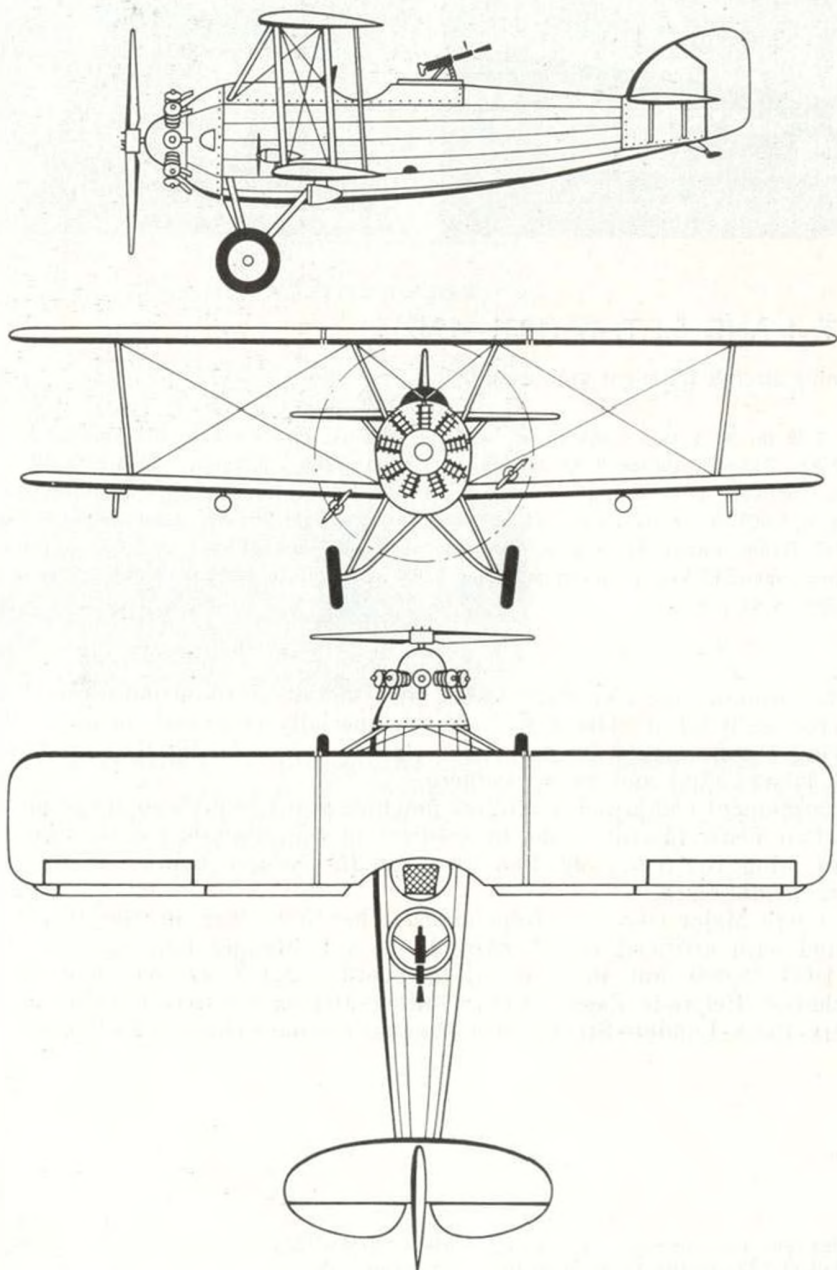



### I.C.A.R.-M23 b (1932)

Primary training and touring aircraft

Span 11.50 m, length 6.50 m, height 2.00 m, empty weight 375 kg, total weight 700 kg  
80-HP Siemens Halske SH 13 b engine, maximum speed 170 km/h, cruising speed 150 km/h,  
minimum speed 80 km/h, maximum ceiling 3,800 m, endurance 5 h 30 min.

This was the first plane produced by the *I.C.A.R.* factory of Bucharest, under a Messerschmitt M-23 licence. On a timber structure, part of the plane was covered by plywood and part of it by fabric.

The *I.C.A.R.-M-23b* was extensively used by the civilian flying schools of Romania. It was also always seen at the air meets of the time. The highly popular Silver Squadron, as the *I.C.A.R.-M-23b* planes of the *A.R.P.A.* Association were called, took up very many people who wanted to have their first experience of air travel. Very good performances were obtained by this type of aircraft thanks to its successful structure and good flying qualities.

In 1932 *Mihail Pantazi* and *Gheorghe Grozea*, flying an *I.C.A.R.-M-23b* with floats and additional fuel tanks, set up a world endurance record for light seaplanes, flying for 12 hours and 2 min.

In 1933 *Mihail Pantazi*, *Gheorghe Davidescu*, *Alexandru Cernescu*, *Petre Ivanovici*, *Max Manolescu* and the mechanic *D. Ploteşteanu*, flying three *I.C.A.R.-M-23b* planes, carried out the first Romanian intercontinental flight over the distance Bucharest-Malakal (Sudan). Although the initial

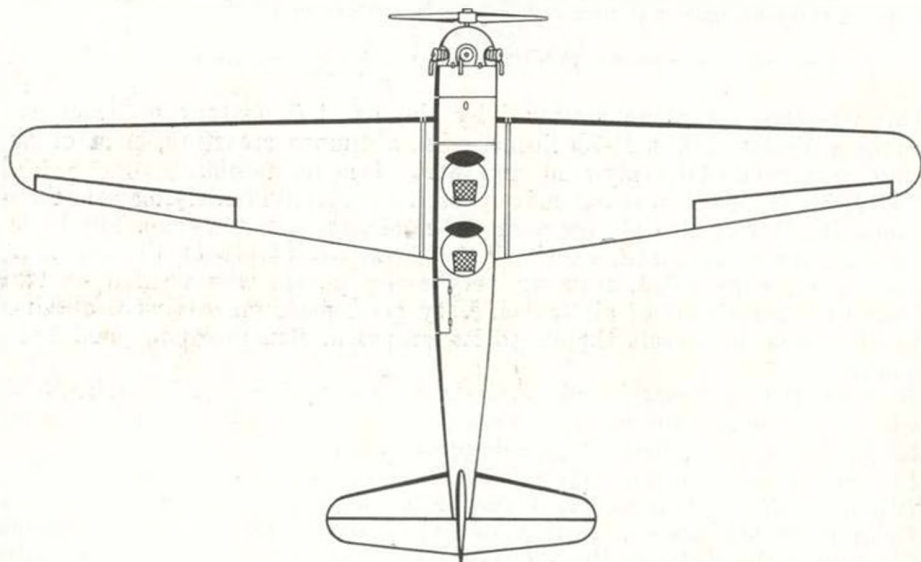
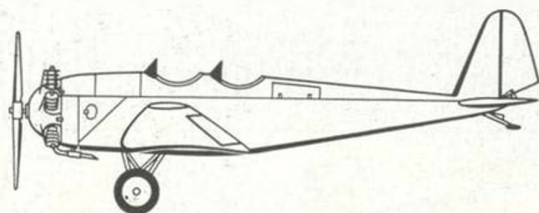





Mihail Pantazi and Gheorghe Grozea with their *I.C.A.R.-M-23b* seaplane, on which they set up the world endurance record in 1932.



*I.C.A.R.-M-23b* planes above the Nile, between Atbara and Khartum.



Romanian crews on Malakal airfield.

target had been Capetown, the flight had to be interrupted at Malakal due to unfavourable weather conditions and because the flying fields had become impracticable after the rains. However, this flight confirmed the good qualities of the planes which proved their worth in the specific meteorological conditions of the African continent.



## S.E.T.-31 G (1932)

Touring aircraft

Span 9.80 m, length 7.20 m, height 3.15 m, wing area 26.60 sq m, empty weight 968 kg, total weight 1,350 kg., 240-HP Lorraine-Mizar 47a engine, maximum speed 210 km/h, minimum speed 80 km/h, maximum ceiling 6,500 m, maximum range 1,500 km.

Similar to the *S.E.T.-31*, from which the *S.E.T.-31 G* single-seater was derived, the latter had a higher endurance due to its additional fuel tanks. In 1932 sports pilot *Ionel Ghica* flew a *S.E.T.-31 G* from Bucharest to Saigon and back, covering a distance of 23,000 km in 140 flying hours. Although this flight was made in stages, it was a remarkable performance, taking into consideration the type of aircraft and the length and difficulty of the route.

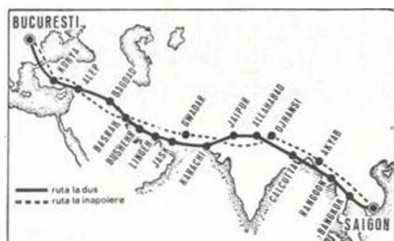

The route of the Bucharest-Saigon-Bucharest long-distance flight.

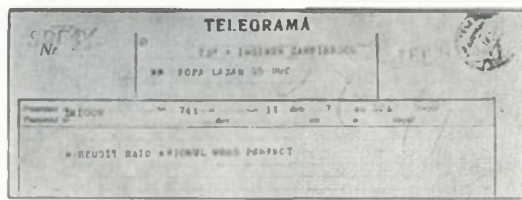

The telegram sent from Saigon to Bucharest, announcing the successful conclusion of the first part of the flight.

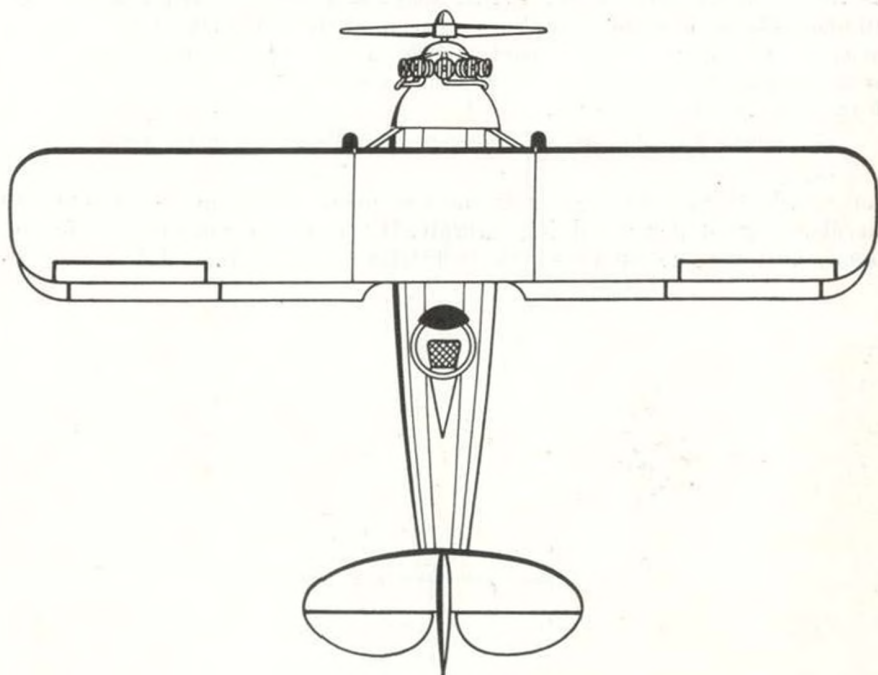
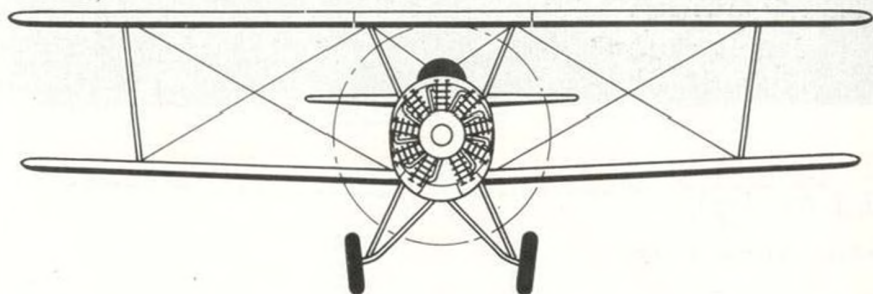
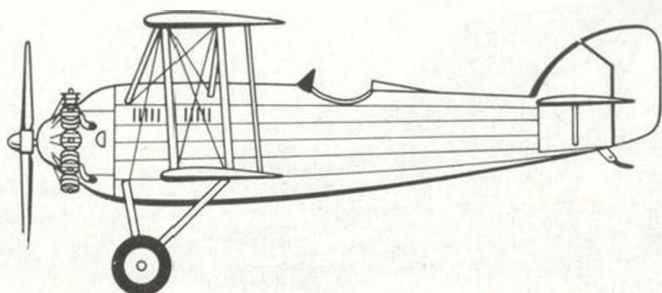



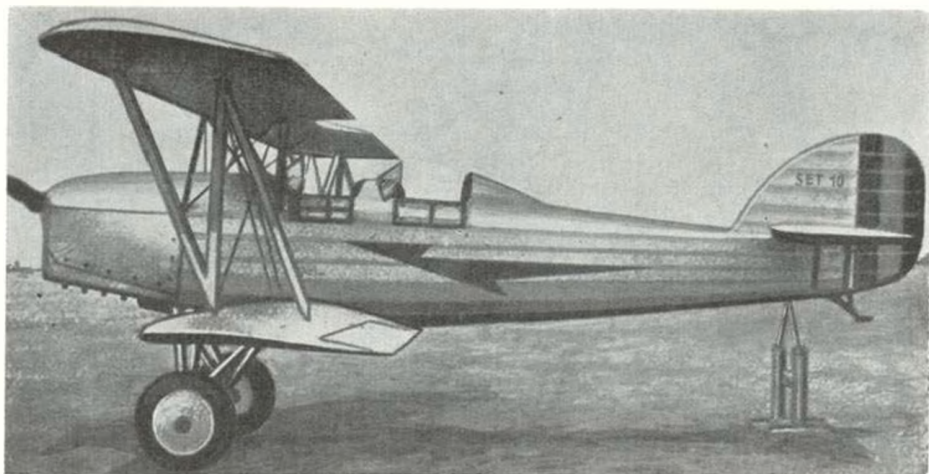

### S.E.T.-10 (1932)

Primary training aircraft

Span 9.46 m, length 7.30 m, height 2.73 m, wing area 22.00 sq m, empty weight 548 kg, total weight 800 kg, prototype with Walter engine, serial planes with 130-HP D.H. Gipsy Major engine, maximum speed 180 km/h, speed at 2,000 m 165 km/h, minimum speed 66 km/h, maximum ceiling 5,500 m, climb to 2,000 m 9 min, climb to 4,000 m 28 min, maximum range 500 km, endurance 3 hours 20 min.

The *S.E.T.-10* had dual controls for the primary training of pilots and it was also a good basic training aircraft. It was mass-produced for the flying schools and for the squadron phase training of military pilots.

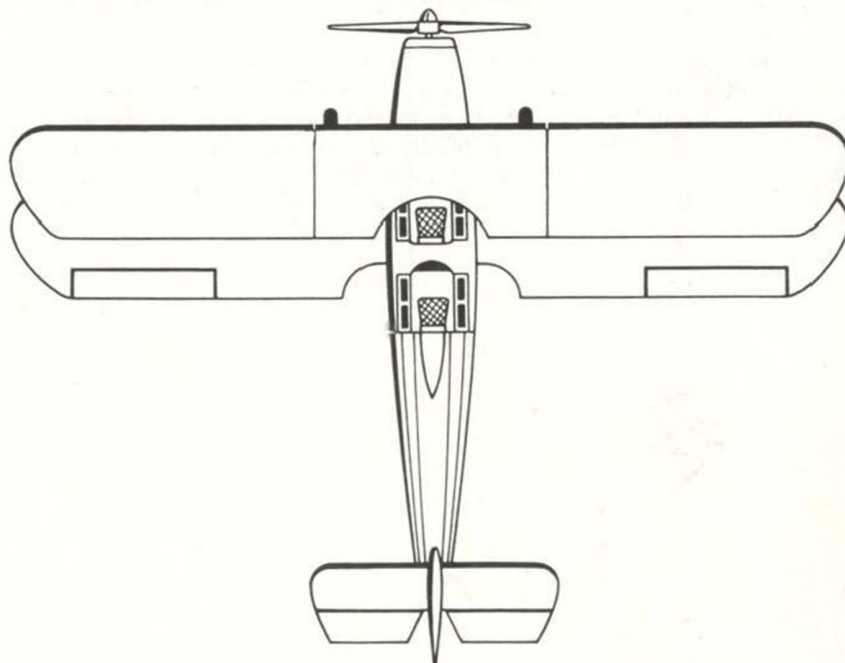
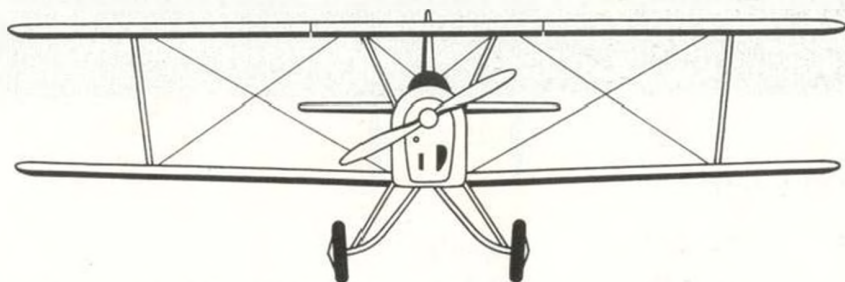

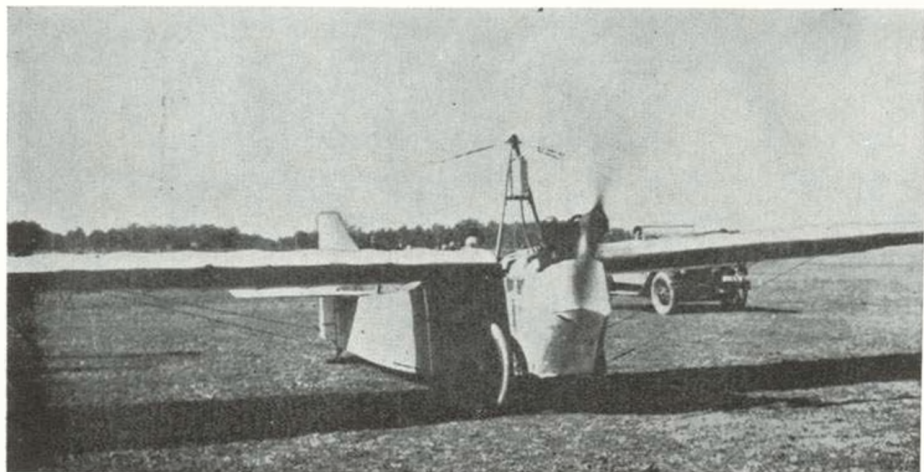

### R.M.-4 (1932)

#### Touring aircraft

Span 8.00 m, length 8.30 m, wing area 12.00 sq m, empty weight 175 kg, total weight 250 kg, payload 75 kg, 12-HP Indian engine, maximum speed 85 km/h, minimum speed 50 km/h.

Designed and built by Engineer *Radu Manicatide*, this light touring monoplane with rectangular wings had a mixed structure, the frame of the wings and of the fuselage being made of timber, with the cover of the wings of fabric and that of the fuselage of plywood. The undercarriage had shock-absorbers on sandows. The engine had a chain reduction device.



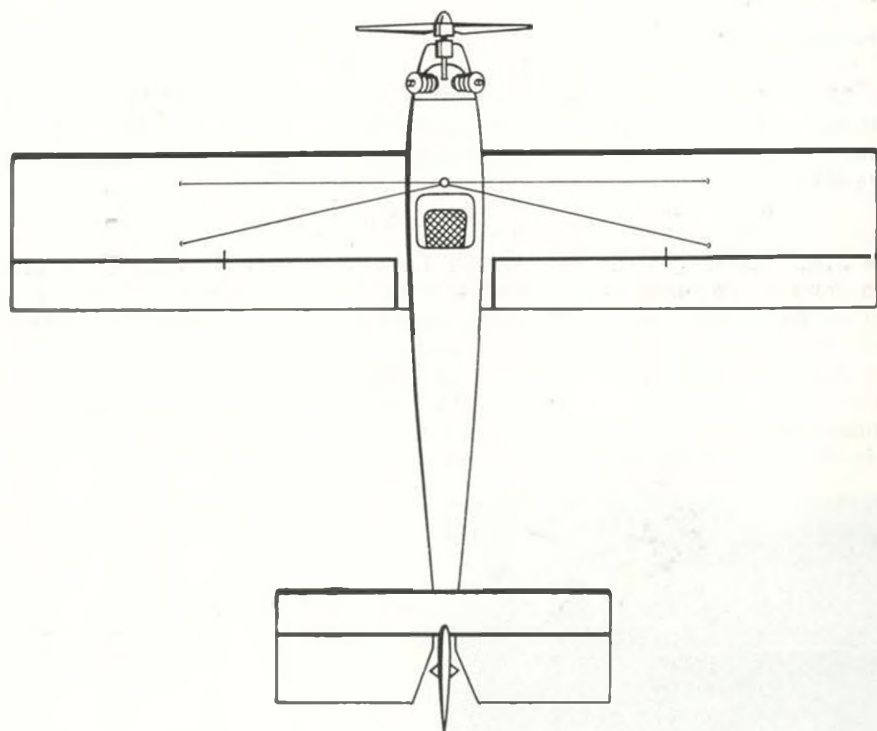
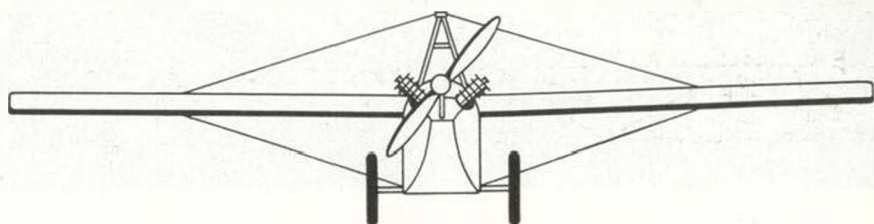
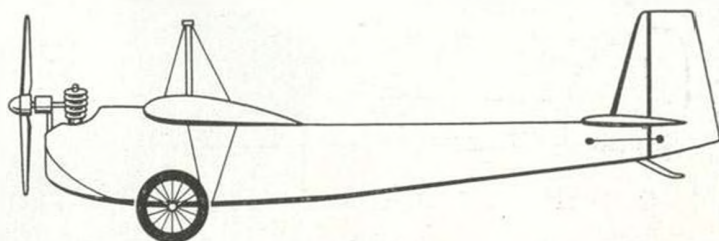

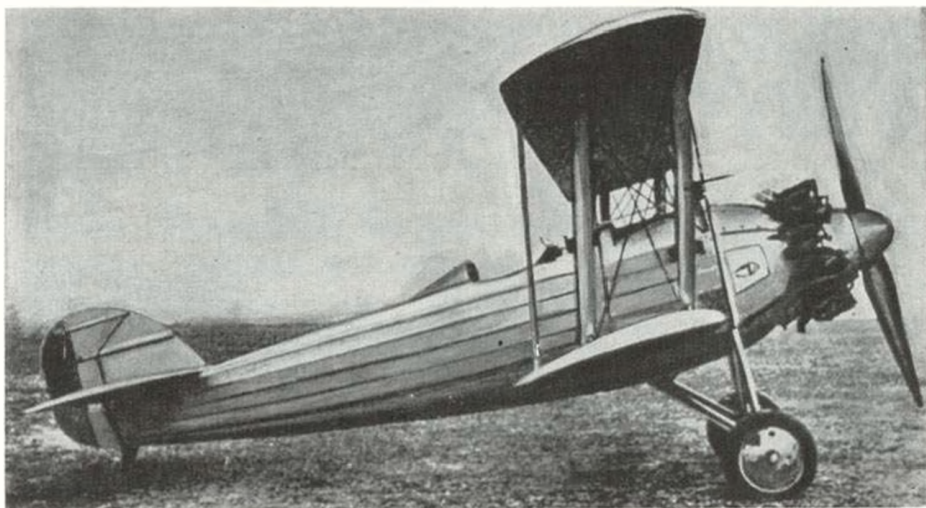

## S.E.T.-X (1932)

Advanced training aircraft

Span 8.70 m, length 7.30 m, wing area 18.50 sq m, empty weight 890 kg, total weight 1,184 kg, 365-HP Jaguar engine, maximum speed 260 km/h, speed at 5,000 m 249 km/h, minimum speed 95 km/h, maximum ceiling 8,000 m, climb to 5,000 m 13 min 47 sec, maximum range 480 km.

The *S.E.T.-X* was specially designed for the advanced training of pilots who were to be posted on fighter aircraft. It was tested by two of the best pilots of the time, Air Force Lieutenants Octav Oculeanu and Ionescu-Beu.

The *S.E.T.-X* was highly manoeuvrable and capable of carrying out the entire range of aerobatic figures. The plane could be equipped with a machine-gun or a photo machine-gun for air target firing. Only two planes of the *S.E.T.-X* type were built.



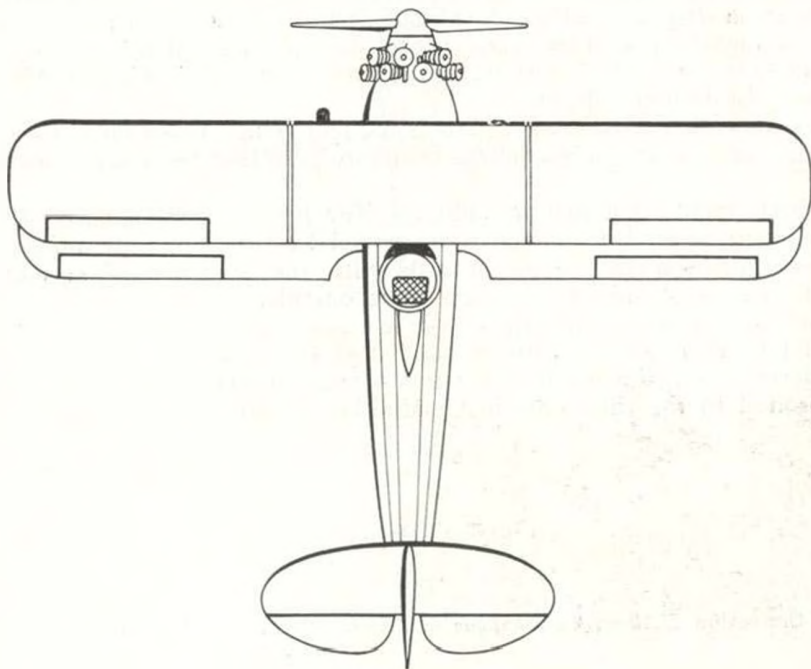
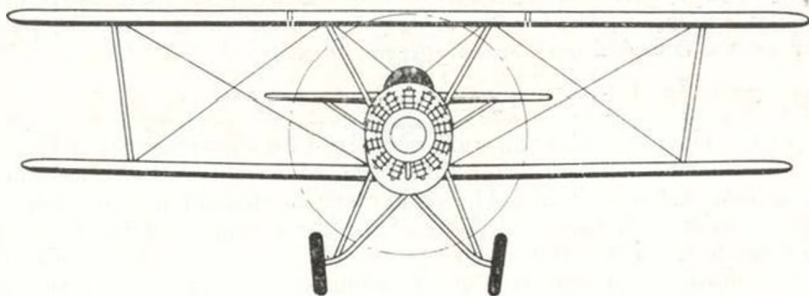
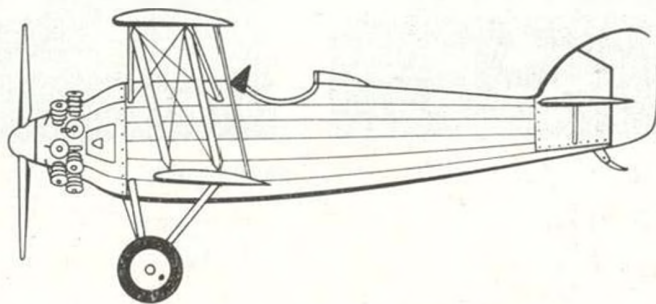





## BRATU-220 (1932)

Commercial airliner

Span 25.00 m, length 17.47 m, height 6.55 m, wing area 83 sq m, empty weight 4,400 kg, total weight 9,000 kg, engines: two Gnôme-Rhône Titan of 230 HP each and one Jupiter of 420 HP (in the fuselage's nose), maximum speed 200 km/h.

The project of this original aircraft, conceived for the transport of 10 passengers, was finished in 1929, after the design of *Romulus Bratu*, a Romanian engineer established in Paris. The characteristic element in the construction formula consisted in the positioning of the three engines along the aircraft's flight axis, a solution never used before. The 1:25 scale model was tested in the laboratories of the *St. Cyr Aeronautical Institute*, and the results, inscribed in the Report 320/A, September 1929, of the *French Office of Aeronautical Research*, attested the successful outcome of the design.\* The components of *Bratu-220*, made in the Athis-Mons works, were assembled in the *C.I.D.N.A. (Compagnie Internationale de Navigation Aérienne)* works at Le Bourget airport.

It was an entirely wooden construction. The wing, based on a Göttingen profile, was sparless, a geodetical structure resulting from the crossing of ribs.

The first flights commenced only on November 26, 1932, the aircraft receiving its airworthiness certificate issued by the *French Technical Aeronautical Service* after a series of tests with the condition of keeping the flying axis using only two of the three engines.

Besides its constructional originality, one also has to notice the *Bratu-220* useful load of 4,500 kg, quite uncommon at that time.

In March 1933, the *Bratu-220* trimotor was presented in flight and on the ground to the then French Air Minister, Pierre Cot.

\* See the review *L'Album du fanatique de l'Aviation*, no. 6, December 1969, p. 7.

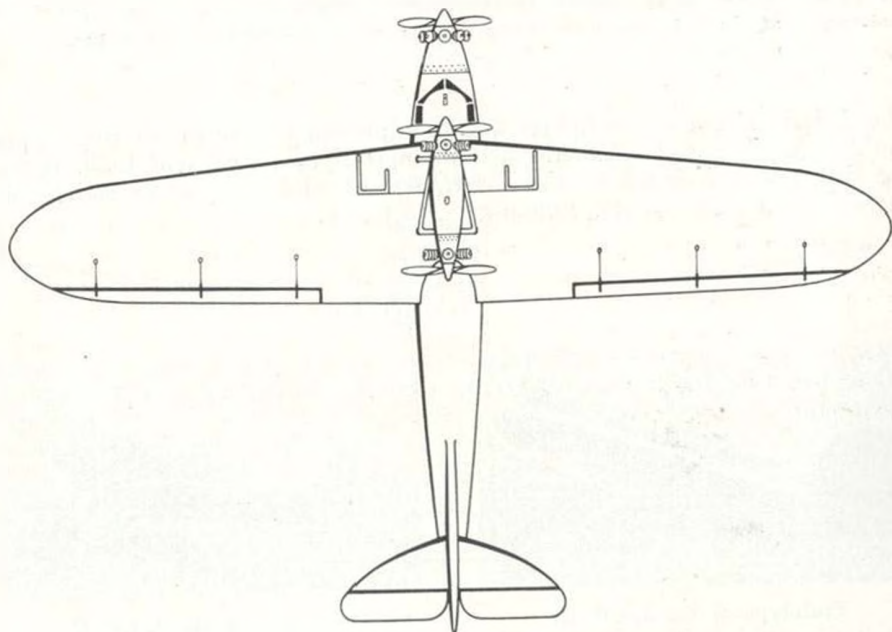
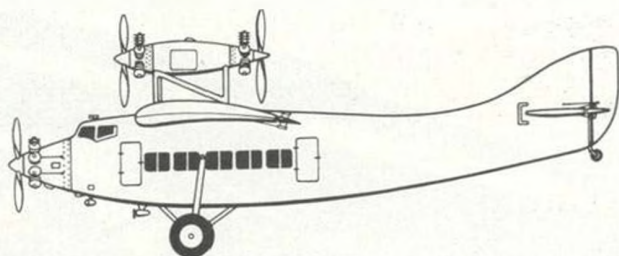

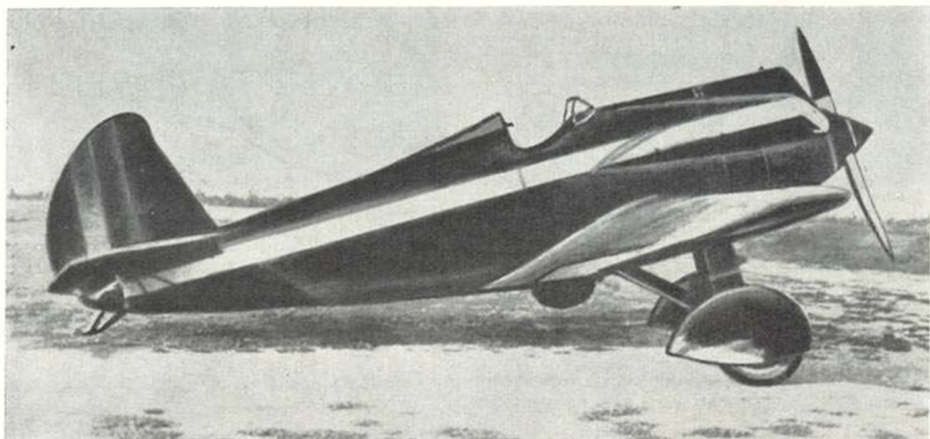

### I.A.R.-14 (1933)

Fighter aircraft

Span 11.70 m, length 7.32 m, height 2.50 m, wing area 19.80 sq m, empty weight 1,150 kg, total weight 1,540 kg, 450-HP Lorraine-Dietrich engine, maximum speed 294 km/h, minimum speed 108 km/h, maximum ceiling 7,500 m, climb to 5,000 m 10 min 45 sec.

The *I.A.R.-14* one-seater fighter was an improved variant of two prototypes, the *I.A.R.-12* and the *I.A.R.-13*, built in the years 1932 and 1933. It was the first plane designed by the *I.A.R.* factory of Braşov to be serial built there for the units of the Romanian Air Force.



Prototype of the *I.A.R.-12*.

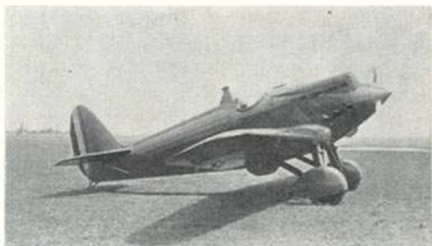

Prototype of the *I.A.R.-13*.



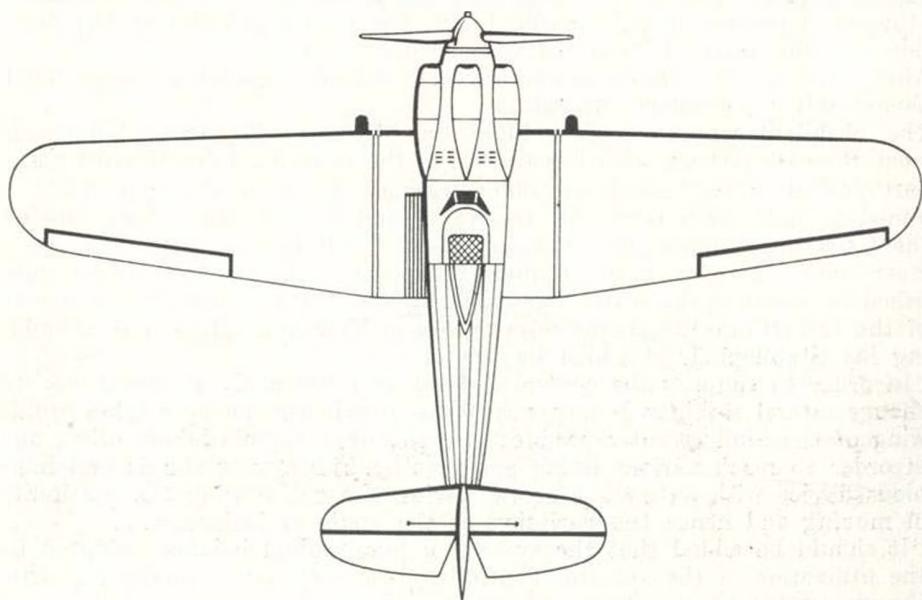
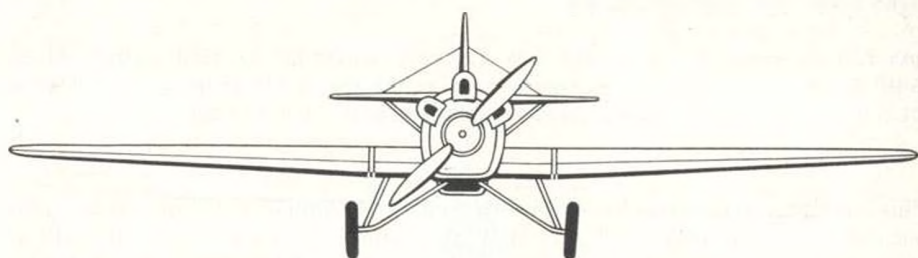
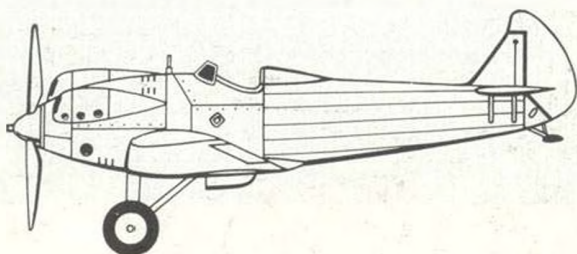



## The FILIP MIHAIL STABILOPLAN (1933)

Light sport and touring aircraft

Span 9.00 m, length 3.70 m, height 2.00 m, empty weight 241 kg, total weight 381 kg, 35-HP Scorpion ABC II engine, maximum speed on the ground 147 km/h, speed at 2,000 m 108 km/h, minimum speed 73 km/h, maximum ceiling 4,000 m, climb to 1,000 m 9 min. 25 sec.

This plane, conceived by *Filip Mihail* and called by him *Stabiloplan* because of its stability in flight, was an original construction. Filip Mihail approached the idea of this plane as far back as 1924, when he started a series of studies on various types of aeroplane models.

The Stabiloplan had no horizontal tail piece, wherefor it was surnamed "the small tailless plane." During flight, the pilot could change the position and the angle of incidence of the wing.

After landing, the wings could be folded to the fuselage and the plane could be put into an ordinary car garage.

The Stabiloplan made its first flight on November 22, 1933, taking off from Băneasa Airport with *Ion Culluri* at the controls. Filip Mihail's plane participated in very many aviation meetings. In June 1934, it made a non-stop flight from Bucharest to Braşov and back to Bucharest, crossing the Carpathian mountains at a height of 3,000 m.

Ever since 1927 Air Force Captain Constantin Mincu (B.Sc., Eng.) published an article in the review *Aeronautica*, Nos. 11—12, about the prospects of the tests Filip Mihail was carrying out at that time with a view to building his Stabiloplan, in which he wrote:

"In order to simplify the control system and especially in order not to change lateral stability in any way, Filip Mihail uses an autostable profile wing of the kind recently produced by the aerodynamic laboratories; and in order to reach various flying positions he uses a very simple and ingenious device with an endless screw, giving the entire wing the possibility of moving and hence the variation of the angle of incidence . . .

"It should be added that the system of longitudinal balance, adopted by the utilization of the autostable profile, is a very early application after the emergence of this type of profiles. . ."

THE FILIP MIHAIL STABILOPLAN

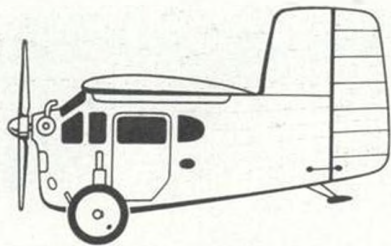



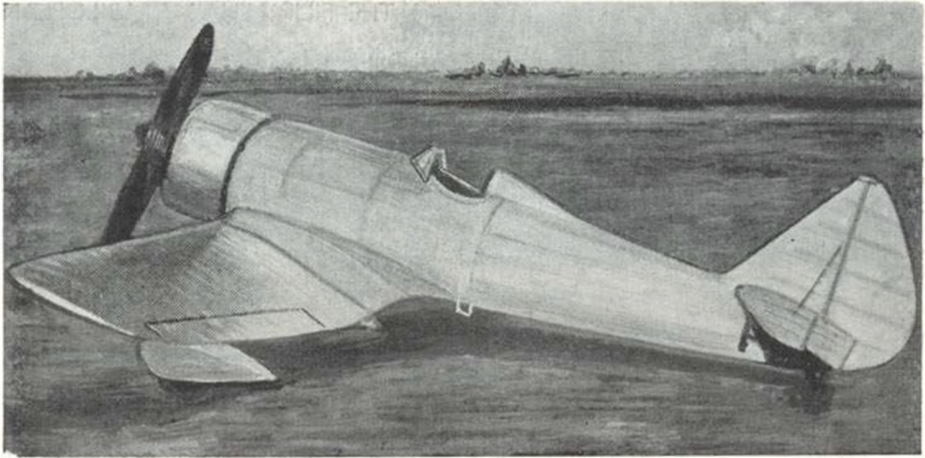

## I.A.R.-15 (1933)

### Fighter aircraft

Span 11.00 m, length 8.29 m, height 2.70 m, wing area 19.00 sq m, empty weight 1,368 kg, total weight 1,707 kg, 600-HP Gnôme-Rhône 9 Krse engine, maximum speed 352 km/h, minimum speed 107 km/h, maximum ceiling 10,000 m, climb to 5,000 m 8 min, maximum range 600 km.

The framework of the *I.A.R.-15* was formed of two box spars made of duraluminium, linked to each other by tubular distance-pieces which increased the torsion strength. The central wing section was covered by duraluminium sheet and the outer wings by fabric. The wings' leading edge was of plywood. The resistance structure of the fuselage was made of welded duraluminium and chromium-molybdenum steel tubes. The front part of the fuselage was covered by duraluminium sheet and the rear part by fabric. The tail had a metal frame and was fabric covered. The stabilizer could be adjusted in flight and the fin on the soil. The elevator had axial and lateral trimming. The landing gear, faired with duraluminium sheet, had mechanical brakes and oil and pneumatic shock absorbers of the *I.A.R.* type.

The engine's *N.A.C.A.* hood was made of metal, having in front the exhaust collector. The oil radiator was of the ring type. The two-blade airscrew was made of wood. The plane carried two fixed machine-guns firing through the airscrew.

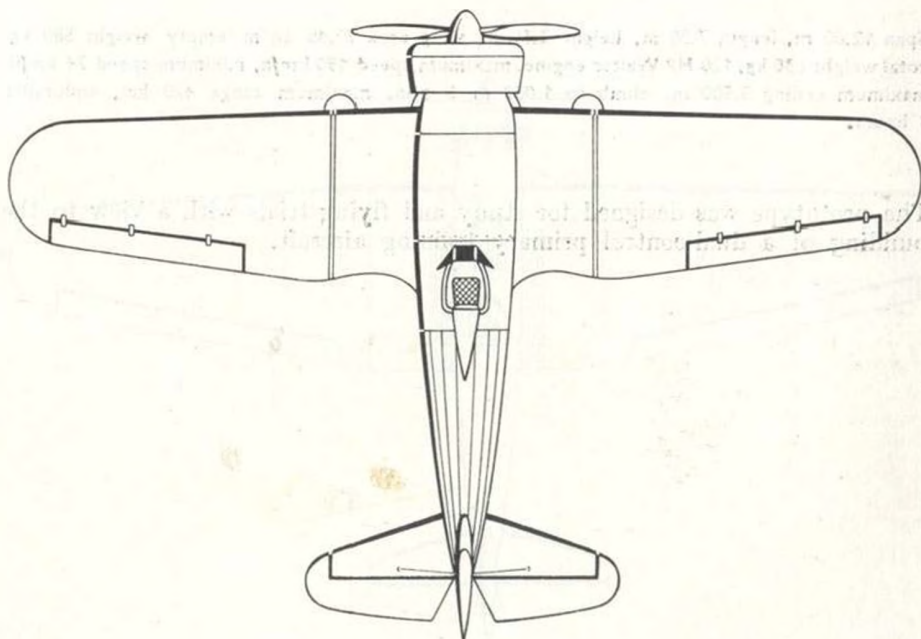
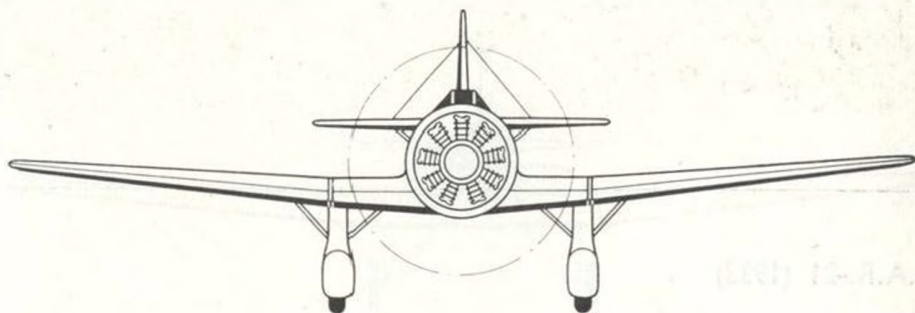
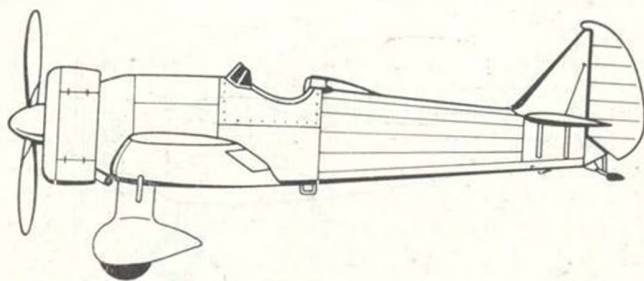

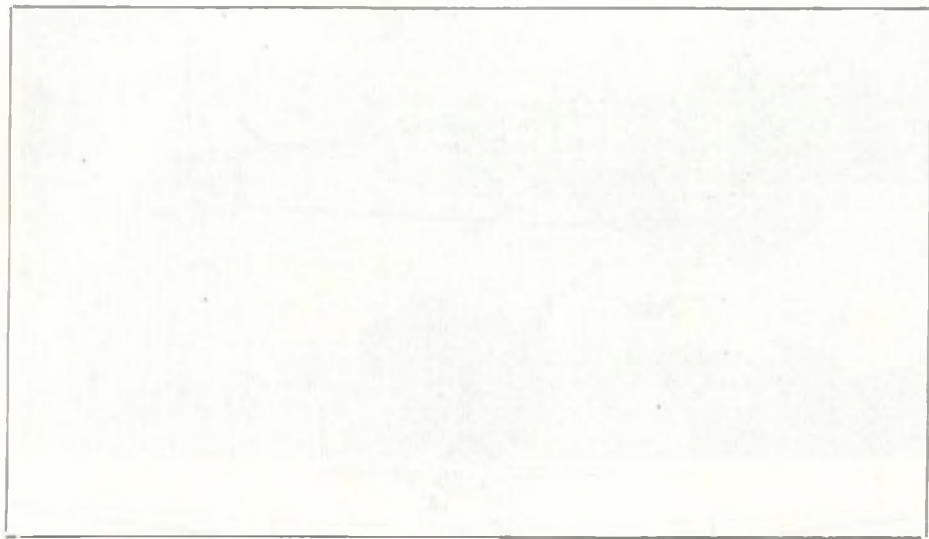

## I.A.R.-21 (1933)

Primary training aircraft

Span 12.00 m, length 7.00 m, height 2.50 m, wing area 20.45 sq m empty weight 580 kg, total weight 850 kg, 120-HP Walter engine, maximum speed 190 km/h, minimum speed 74 km/h, maximum ceiling 5,500 m, climb to 1,000 m 5 min, maximum range 420 km, endurance 3 hours.

The prototype was designed for study and flying trials with a view to the building of a dual-control primary training aircraft.



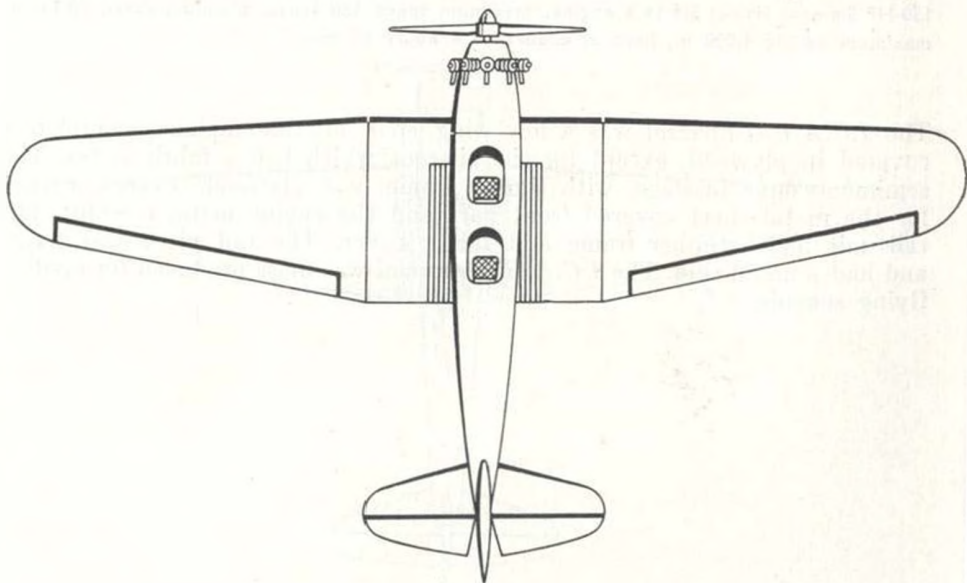
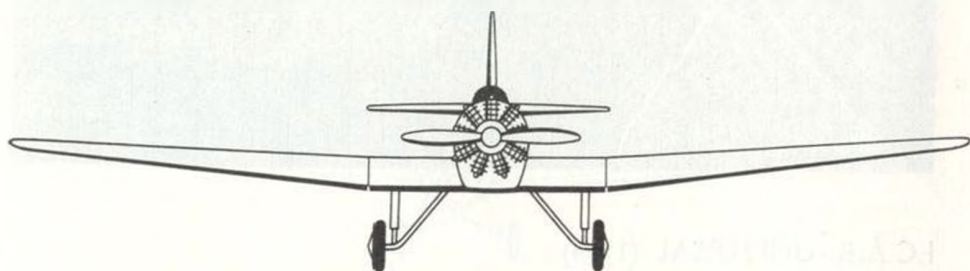
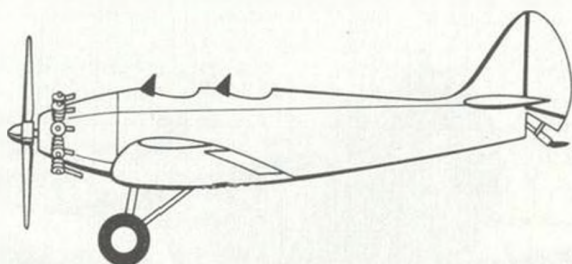

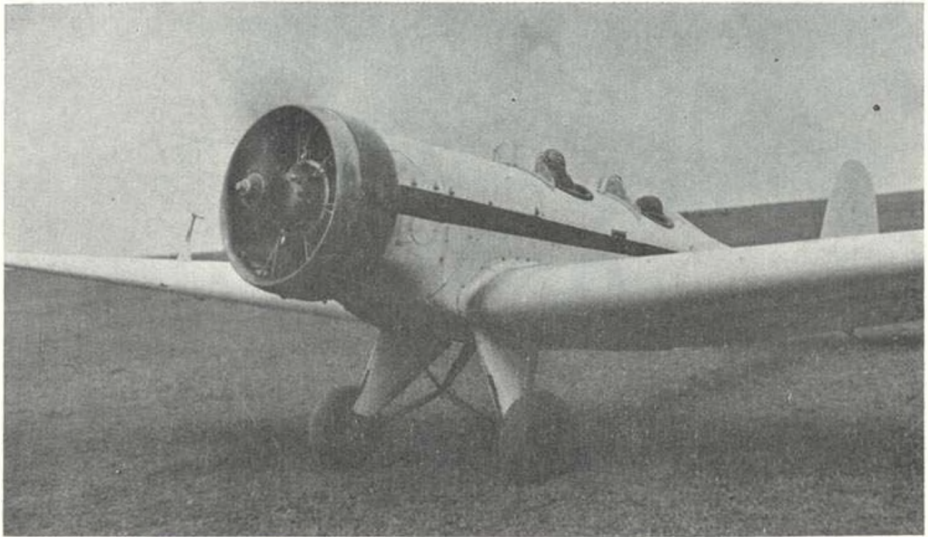

## I.C.A.R.-UNIVERSAL (1934)

Training and touring aircraft

Span 11.85 m, length 6.75 m, height 2.50 m, empty weight 450 kg, Max. T. O. weight 825 kg, 150-HP Siemens Halske SH 14 a engine, maximum speed 180 km/h, minimum speed 70 km/h, maximum ceiling 4,000 m, limit of endurance 4 hours 30 min.

The *I.C.A.R.-Universal* was a low wing spar box monoplane, completely covered in plywood, except for the ailerons which had a fabric cover. The semimonocoque fuselage, with timber frame, was plywood covered, except for the metal sheet covered front part and the engine metal cowling. The tail unit had a timber frame and fabric cover. The tail piece was fixed, and had a metal skid. The *I.C.A.R.-Universal* was mass produced for civilian flying schools.

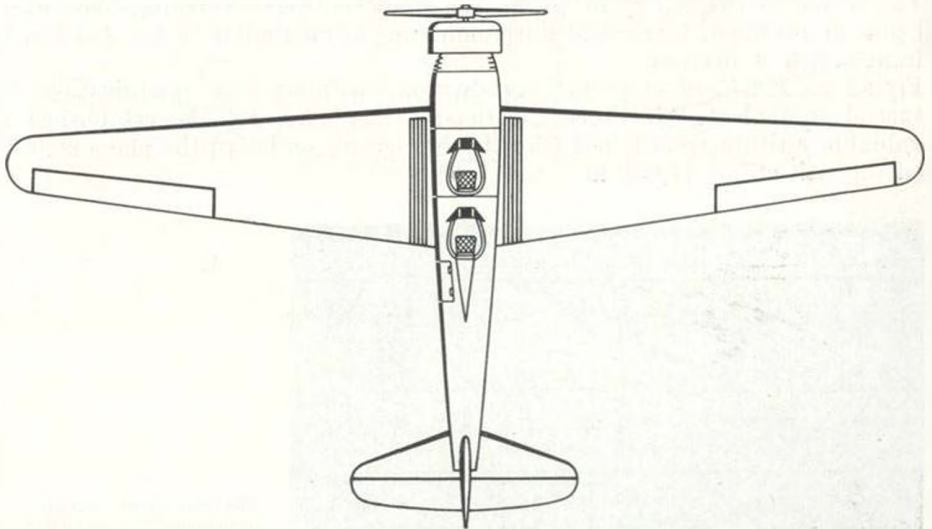
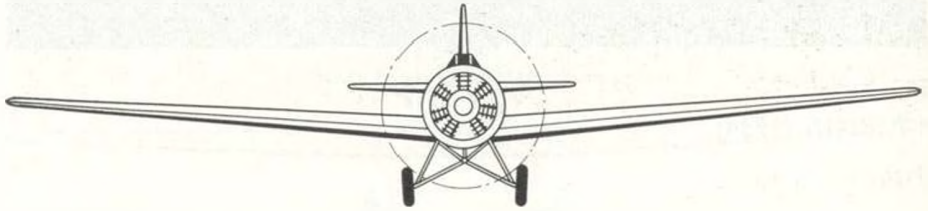
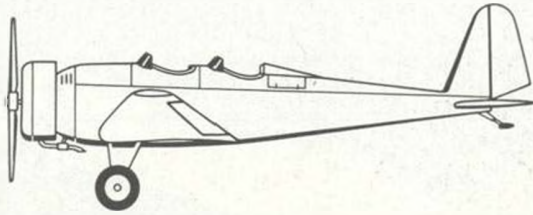



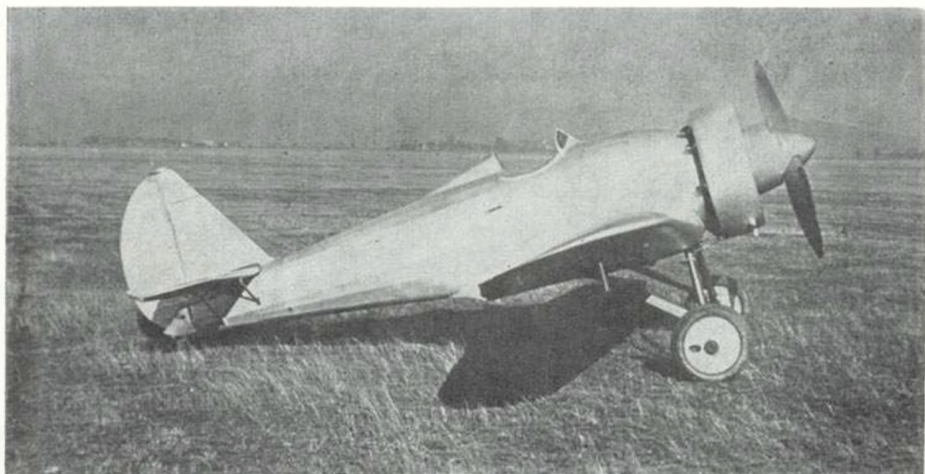

## I.A.R.-16 (1934)

Fighter aircraft

Span 11.70 m, length 7.37 m, height 2.80 m, wing area 20.30 sq m, empty weight 1,224 kg, total weight 1,650 kg, 500-HP Bristol Mercury IV S2 engine, maximum speed 342 km/h, minimum speed 110 km/h, maximum ceiling 10,000 m, climb to 5,000 m 6 min 6 s.

The frame of the *I.A.R.-16* plane was made entirely of metal, the cover being of plywood, fabric and duraluminium, being similar to the *I.A.R.-15*, from which it derived.

Flying an *I.A.R.-16* of normal production, without any modification or special equipment, Air Force Lieutenant *Alexandru Papană* established a valuable altitude record in 1935; the barograph on board the plane recorded an altitude of 11,631 m.

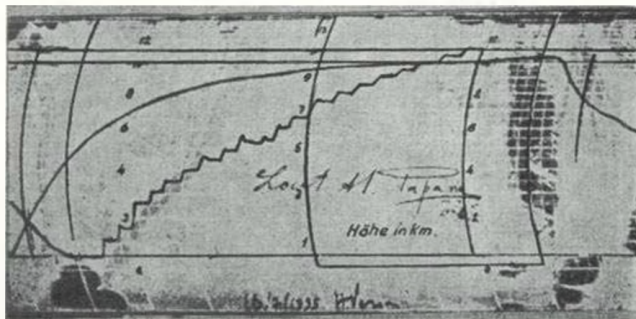

The barogram which registered the record.

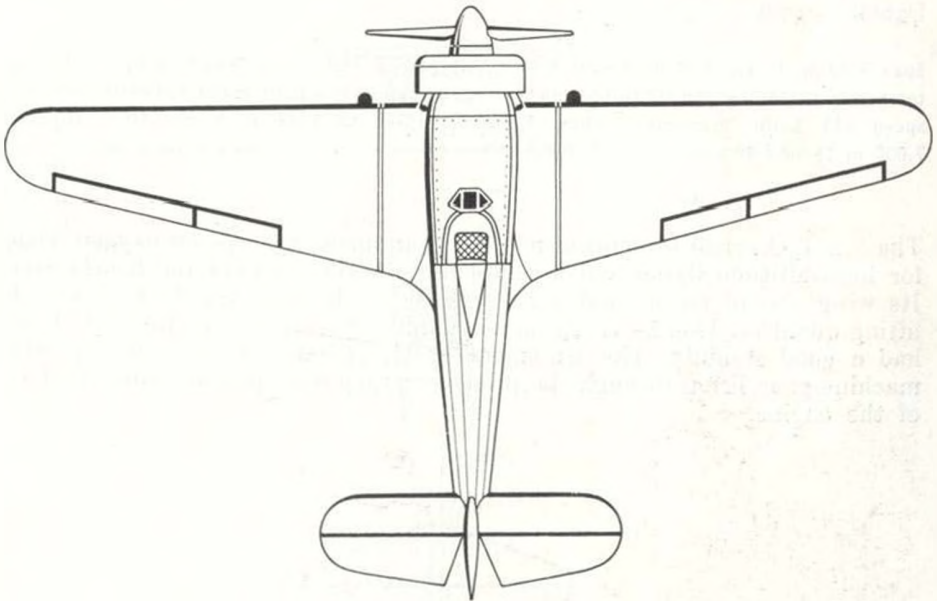
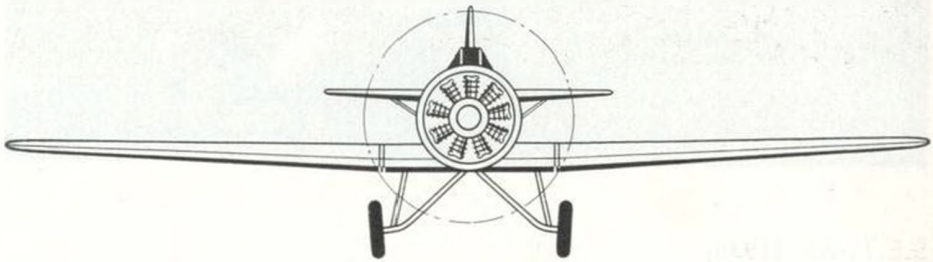
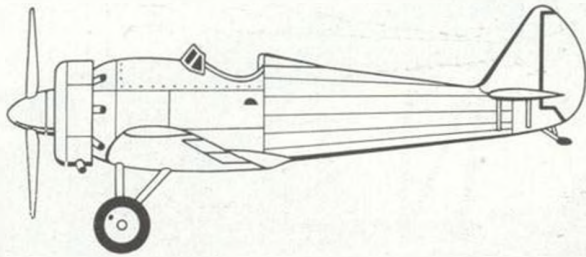



## S.E.T.-XV (1934)

### Fighter aircraft

Span 9.40 m, length 7.00 m, height 3.05 m, wing area 18.65 sq m, empty weight 1,150 kg, total weight 1,550 kg, 500-HP Gnome-Rhône 9 Krsd engine, maximum speed 350 km/h, minimum speed 113 km/h, maximum ceiling 9,400 m, climb to 2,000 m 3 min 10 s, climb to 7,000 m 15 min 30 s.

The *S.E.T.-XV* had a metal frame. Its equipment included an oxygen feeder for high altitude flying and a complete radio set (receiver and transmitter). Its wing was of an original *S.E.T.* profile with flaps, which increased the lifting qualities. Thanks to its aerodynamic characteristics, the *S.E.T.-XV* had a good stability. The armament of the plane consisted of two fixed machine-guns firing through the propeller; they were placed under the hood of the engine.



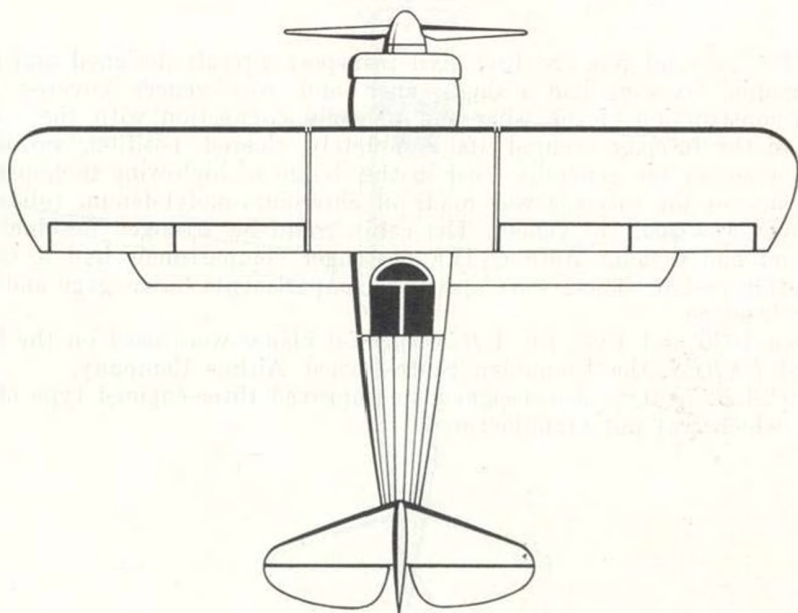
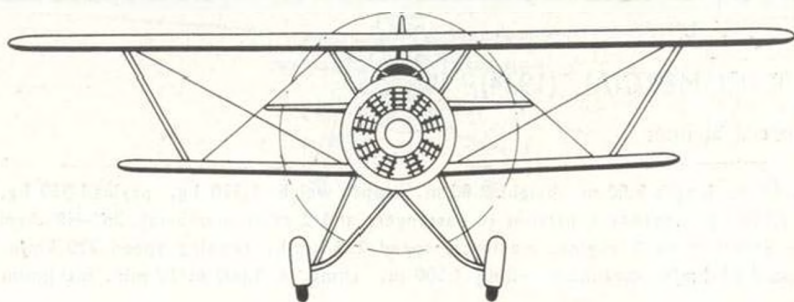
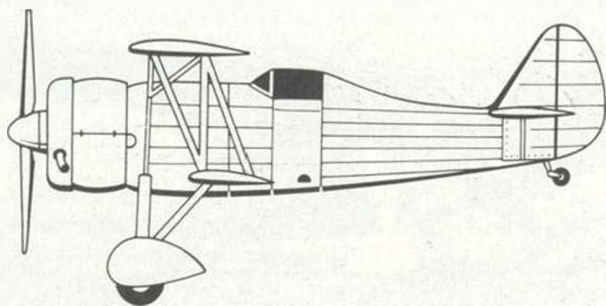

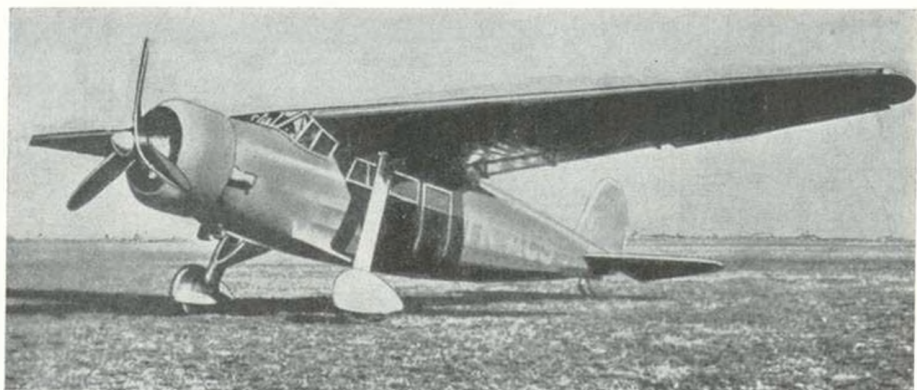

## I.C.A.R.-COMERCIAL (1934)

Commercial airliner

Span 15.40 m, length 9.80 m, height 2.80 m, empty weight 1,320 kg, payload 930 kg, total weight 2,250 kg, capacity 8 persons (6 passengers and 2 crew members), 340-HP Armstrong Siddeley Serval Mark 1 engine, maximum speed 235 km/h, cruising speed 220 km/h, minimum speed 89 km/h, maximum ceiling 4,500 m, climb to 3,000 m 17 min, maximum range 700 km.

*I.C.A.R.-Comercial* was the first civil transport aircraft designed and built in Romania. Its wing had a single spar and was veneer covered. The robust construction of the wing and its solid connection with the central frame of the fuselage secured its completely cleared position, no struts being necessary (as generally used in the design of high-wing monoplanes). The frame of the fuselage was made of chromium-molybdenum tubes and the cover was made of veneer. The cabin could be arranged for dual-controls and had a radio station. The passenger compartment had a special ventilation system. There were also two compartments for luggage and mail in the fuselage.

Between 1936 and 1938 *I.C.A.R. Comercial* planes were used on the home lines of *LARES*, the Romanian State-Owned Airline Company. The *I.C.A.R.* factory also designed an improved three-engined type of this plane, which was not manufactured.

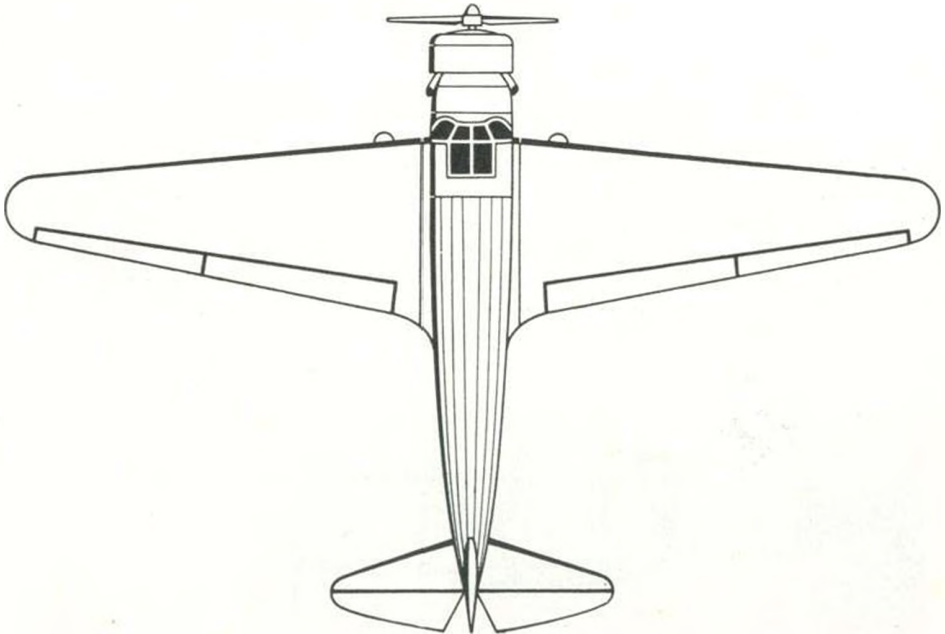
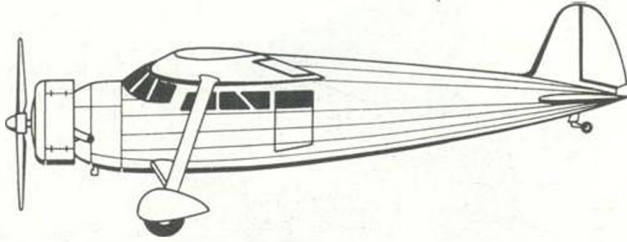





### S.E.T.-7K (1934)

Observation aircraft

Span 9.80 m, length 7.72 m, height 3.26 m, wing area 26.60 sq m, empty weight 1,010 kg, total weight 1,650 kg, 380-HP Gnôme-Rhône 7 Ksd engine, maximum speed 320 km/h, speed at 2,000 m 250 km/h, minimum speed 92 km/h, maximum ceiling 7,000 m, climb to 2,000 m 6 min 14 s, climb to 4,000 m 13 min 5 s.

The *S.E.T.-7K* was built in series for the units of the Romanian Air Force. It differed from the *S.E.T.-7*, from which it was derived, by the all-metal structure of the fuselage. The special equipment of the *S.E.T.-7K* consisted of a radio set and an aerial camera. Its armament consisted of two machine-guns, a fixed one in the hood of the engine, controlled by the pilot, and another in a rear turret, manned by the observer. Under the lower wing, the *S.E.T.-7K* had two bomb racks.

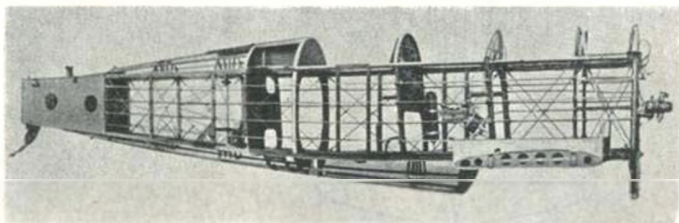

The frame of the  
*S.E.T.-7 K* fuselage.

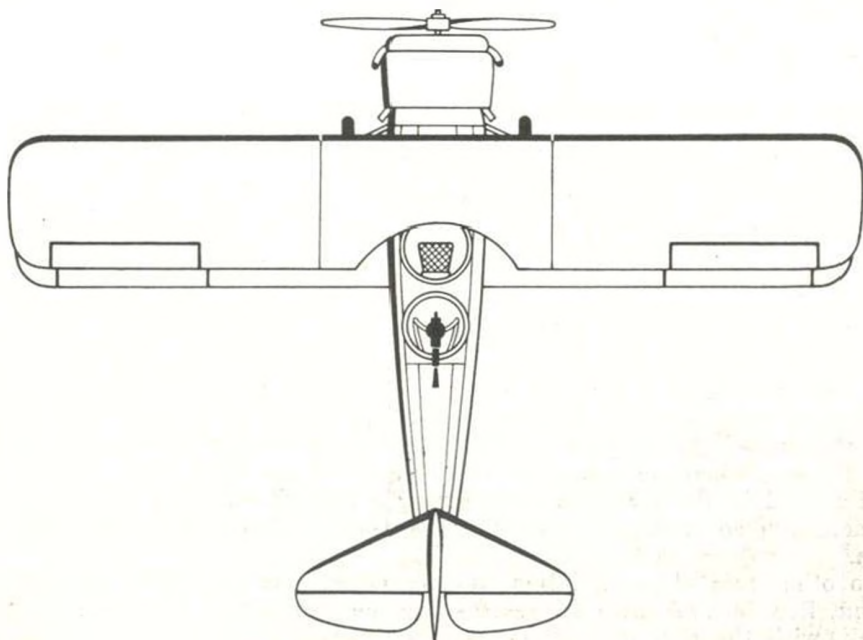
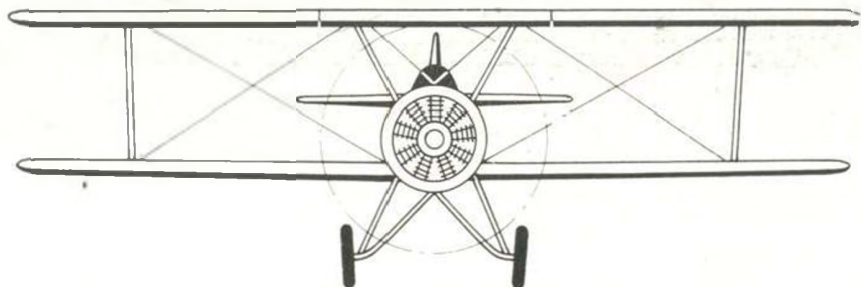
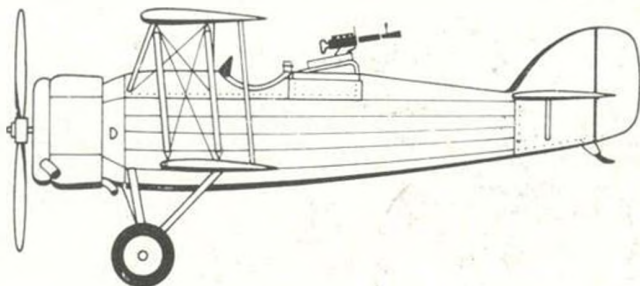

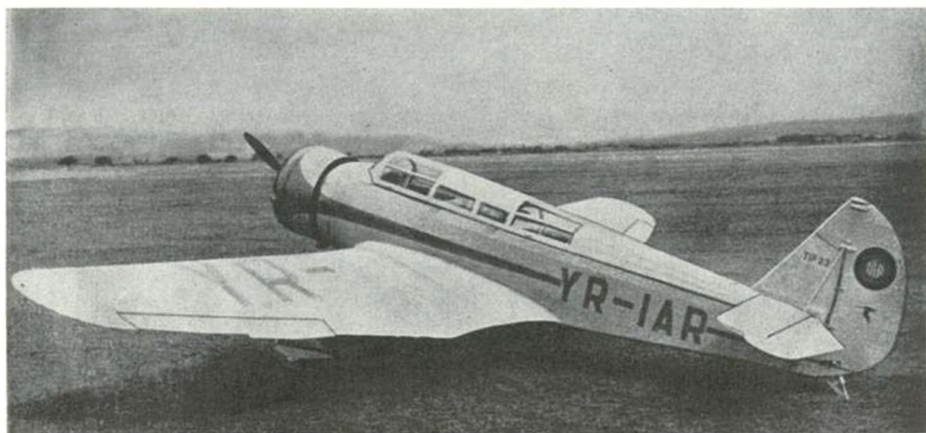

### I.A.R.-23 (1934)

Long-range touring aircraft

Span 12.00 m, length 8.35 m, height 2.70 m, wing area 22.30 sq m, empty weight 980 kg, total weight 1,920 kg, 340-HP Hispano-Suiza 9 Qa engine, maximum speed 245 km/h, cruising speed 215 km/h, minimum speed 105 km/h, maximum ceiling 4,100 m, climb to 1,000 m 5 min 30 s, maximum range 2,300 km.

The *I.A.R.-23* two-seater had a mixed timber and metal construction. The frame of the wing was made of two boxed spars made of spruce, with ribs of veneer. The fuselage, of a lattice structure, was made of spruce. The undercarriage had oil and pneumatic shock-absorbers and brakes of the *I.A.R.* type. The metal airscrew was of the ground adjustable pitch type. The plane had six fuel tanks, two of which were placed in the fuselage and four in the wings, between the spars. The cockpit was specially equipped for long-distance flights.

In 1934, Major *Gheorghe Bănciulescu* achieved an outstanding feat with an *I.A.R.-23*, making three international long-distance flights within 5 days. On September 15, at 5.40 a.m., he took off from Bucharest (Pipera) and landed at 10.25 a.m. in Warsaw; he left Warsaw at 12.55 p.m. and arrived in Bucharest at 17.22 p.m. On September 18 he left Bucharest at 6.24 a.m. for Prague, where he landed at 11.30 a.m. After a brief halt, he took off and landed in Bucharest at 18.00 p.m. The following day, on September 19, Bănciulescu covered the route Bucharest-Vienna-Paris in 8 hours and 40 min.

Two other aces of our aviation, *Alexandru Papană* and *Alexandru Popișteanu*, flew in 1935 with an *I.A.R.-23* from Bucharest to Tel-Aviv and back, with the aim of studying this air route.



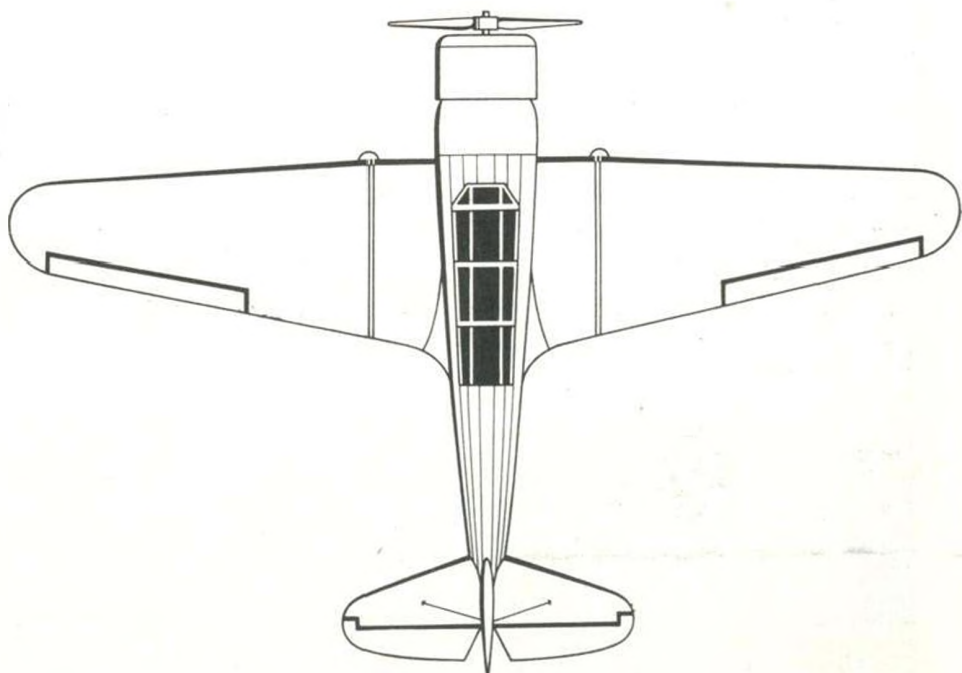
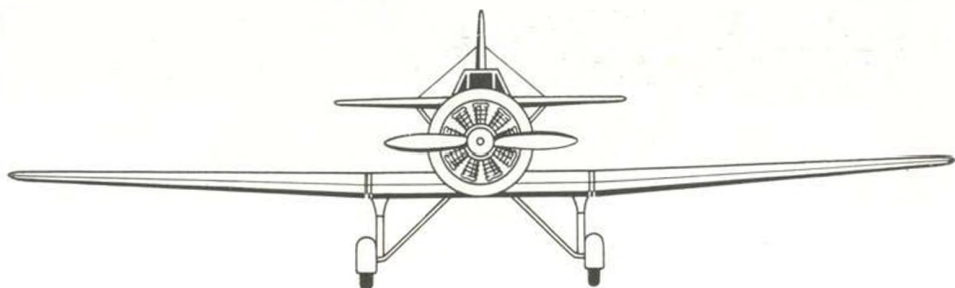
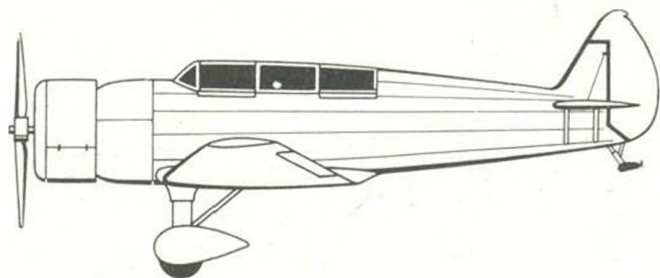

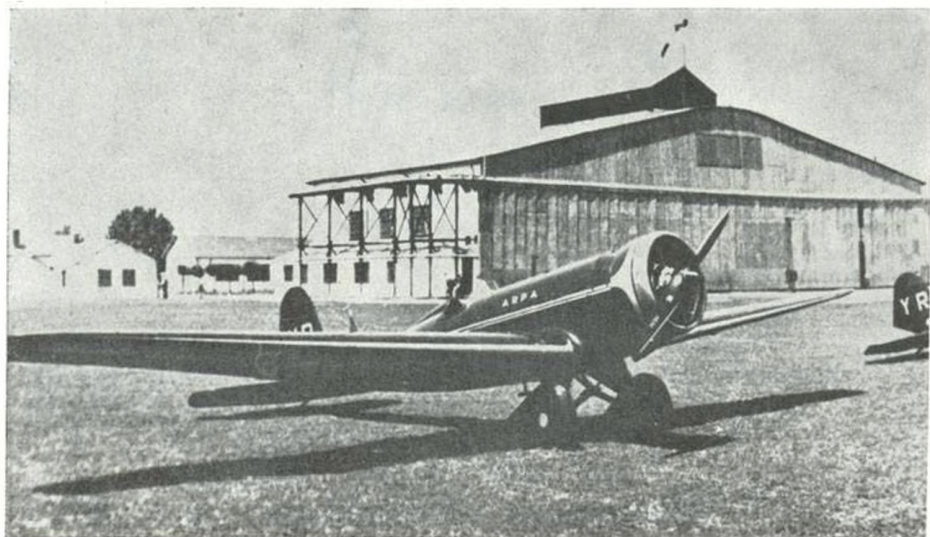

### I.C.A.R.-UNIVERSAL (1934)

One-seater aerobatic aircraft

Span 12.90 m, length 6.75 m, height 2.50 m, empty weight 450 kg, total weight 698 kg, 150-HP Siemens Halske SH 14a engine, maximum speed 180 km/h, minimum speed 70 km/h

This plane, resulting from a transformation of the previously described *I.C.A.R.-Universal* two-seater, was considered for a long time as the most successful aerobatic aircraft built in this country. The three *I.C.A.R.* planes of the well-known *Dracii roșii* (*Red Devils*) squadron, so named because of the great daring of its pilots in aerobatic flights and due to the colour of the planes, participated in all the aviation meetings held in the years 1934-1937.



The *Dracii roșii* (*Red Devils*) squadron, with three *I.C.A.R.-Universal* aerobatic single-seaters, flying above Bucharest during an air show.

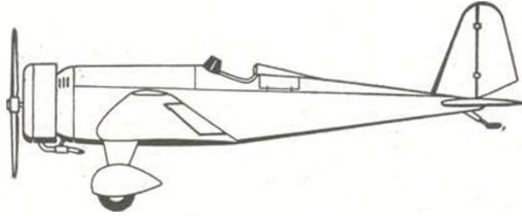





## AERON (1934)

Basic training aircraft

Span 9.80 m, length 6.45 m, height 2.45 m, empty weight 760 kg, total weight 1,010 kg, 120-HP Salmson 9 Ac engine, maximum speed 187 km/h, minimum speed 65 km/h, maximum ceiling 4,200 m.

The *Aeron* was built by the Aeronautical Arsenal of Bucharest after the design of a team which included Captain *Constantin Istrate* (B. Sc., Eng.), Captain *Cristea Constantinescu* (B. Sc., Eng.), Air Force Major *Petre Macovei* and Lieutenant *Simion Stănculescu* (B. Sc., Eng.). Two prototypes were made and both of them underwent test flights. The first, having a 105-HP *Cirrus* engine, was a biplane with wings of unequal span and an original fairing of the undercarriage. The second prototype, whose specifications and performance are recorded above, was also a biplane, one of whose features was that the lower wing was not only staggered in relation to the upper wing, but also there were no struts or webs between the wings.

The *Aeron* was also flown by the French pilot *Lepreux*, who was greatly satisfied with the behaviour of the plane.

One of the newspapers of the time wrote under the headline "A New Romanian Aircraft":

"... After the S.E.T. plane of Eng. Zamfirescu, the new *Aeron* represents an indubitable confirmation of the skill of our aircraft constructors. The State should continue to encourage them for the good of our national industry."

Despite its promising features, the *Aeron* was not mass-produced.

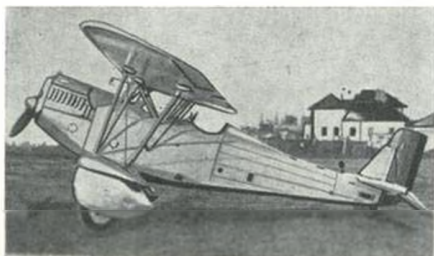

The first variant of the *Aeron*, powered by a *Cirrus* engine.

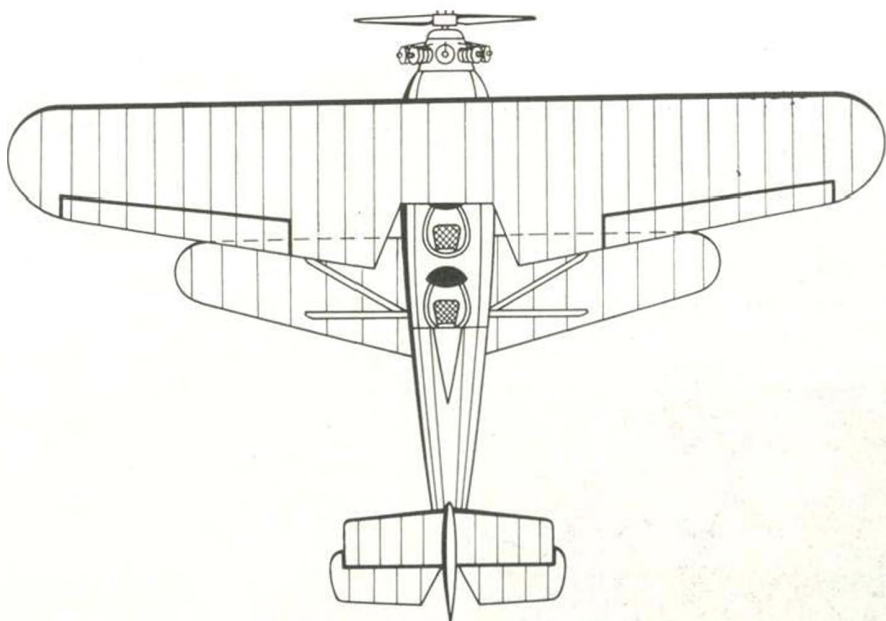
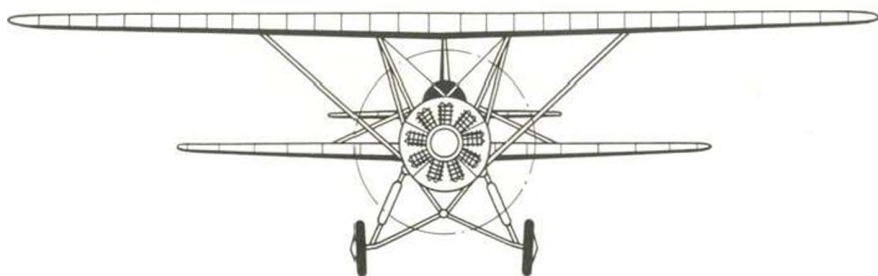
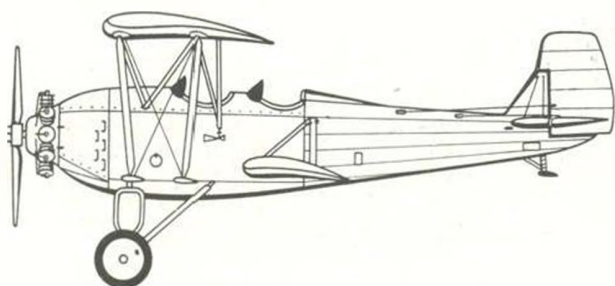

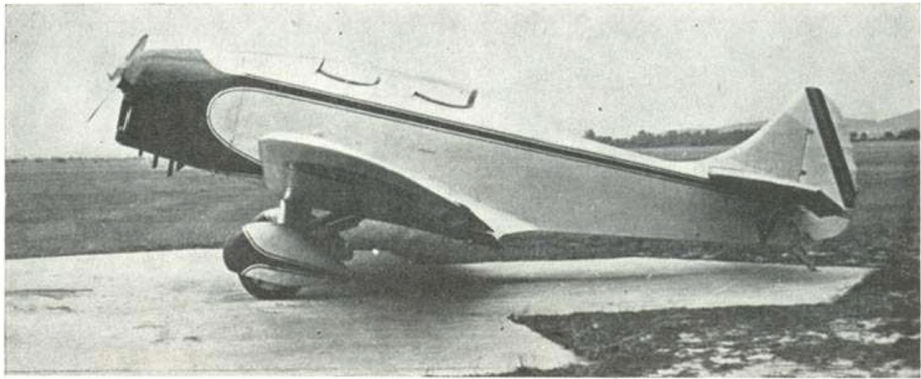

## I.A.R.-22 (1934)

Training and touring aircraft

Span 11.53 m, length 7.50 m, height 2.02 m, wing area 20.80 sq m, empty weight 647 kg, total weight 880 kg, 130-HP D. H. Gypsy Major engine, maximum speed 193 km/h, minimum speed 73 km/h, maximum ceiling 5,000 m, climb to 1,000 m 5 min. 7 sec, maximum range 550 km.

This two-seater dual-controlled plane had the wing's frame formed of two boxed spars, made of spruce and with veneer webs. The leading edge and the entire surface of the central wing-section were veneer covered, the rest of the wings being fabric covered. The fuselage, of the lattice girder type, was made of spruce and the engine support was made of welded steel pipes. The tail unit had the same timber structure. Its fixed parts were covered by veneer and the mobile parts in fabric. The undercarriage had oil-pneumatic shock-absorbers of the *Cleveland* type and mechanical brakes. The *I.A.R.*-type airscrew was made of timber.

In 1935, pilot *Petre Ivanovici* and sports flyer Miss *Irina Burnaia* took an *I.A.R.-22* to Africa down to the northern shore of Lake Victoria, at Entebbe (Uganda). During this long-distance flight both the plane and the engine — built under licence by the *I.A.R.* works — proved to be very good.



*Petre Ivanovici* and *Irina Burnaia* before leaving on the first stage of their long-distance flight.



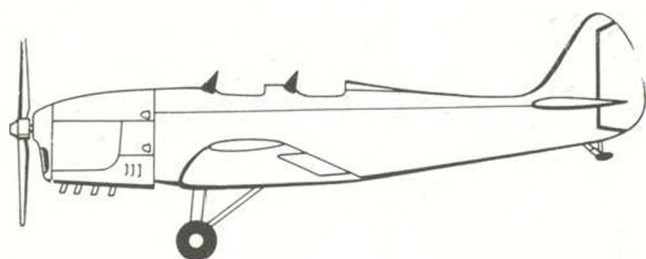

4

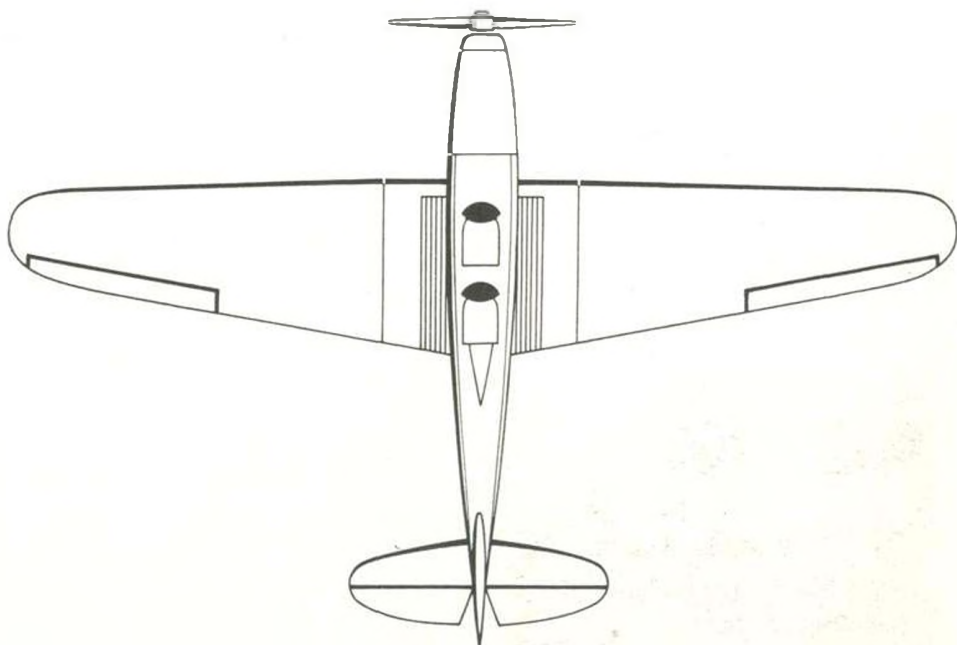



### P.Z.L.-11 F (1934)

Fighter aircraft

Span 10.72 m, length 7.56 m, height 2.90 m, wing area 17.90 sq m, empty weight 1,108 kg, total weight 1,590 kg, 600-HP I.A.R. K 9 engine, maximum speed 300 km/h, maximum ceiling 10,000 m, climb to 5,000 m 6 min, climb to 8,000 m 13 min, maximum range 700 km.

This single-seater high-wing monoplane fighter was built by the *I.A.R.* factory of Braşov under a licence from the Polish factory *Państwowe Zakłady Lotnicze*; the *I.A.R.* variant had a Romanian-made engine. Being very manoeuvrable, this plane was capable of easily carrying out all aerobatic figures. The *P.Z.L.-11 F* was a fighter plane widely used not only by the Polish Air Force, but also by many other foreign air forces.



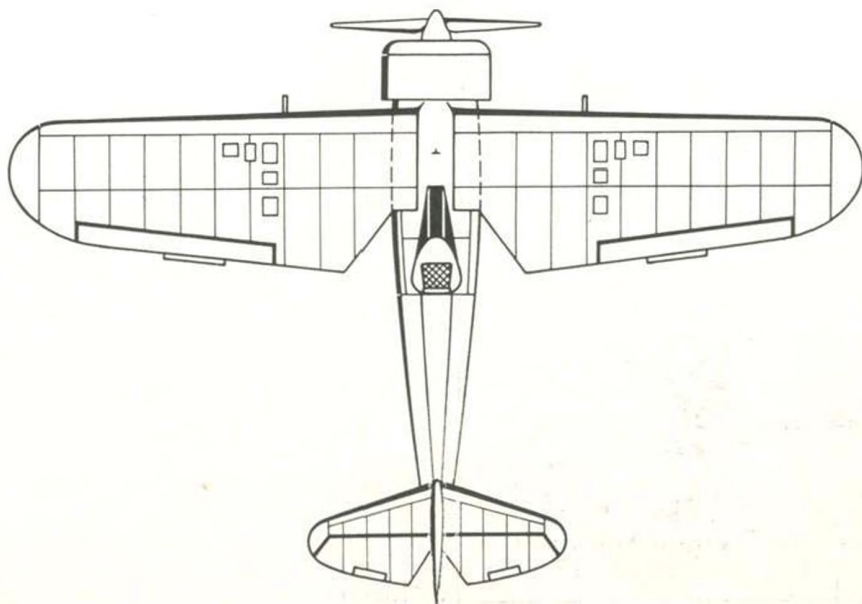
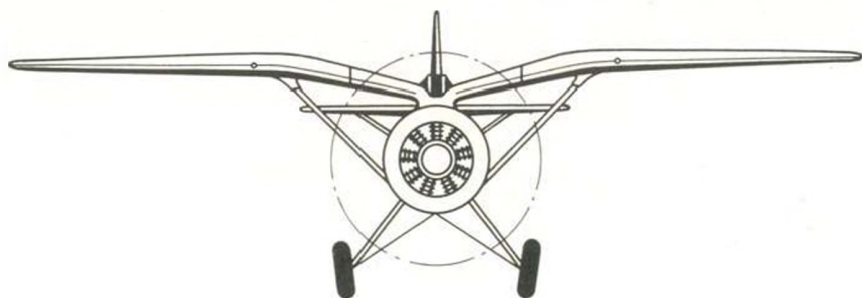
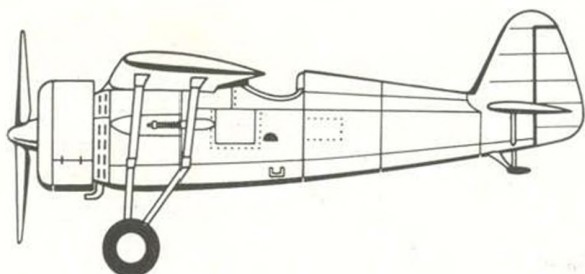





### I.C.A.R.-UNIVERSAL (1934)

Training and touring aircraft

Span 11.90 m, length 6.90 m, height 1.95 m, wing area 14.30 sq m, empty weight 465 kg, total weight 710 kg, 130-HP De Havilland-Gipsy Major engine, maximum speed 195 km/h, cruising speed 160 km/h, maximum ceiling 5,500 m, climb to 3,000 m 12 min 30 sec, endurance 3 hours.

The *I.C.A.R.-Universal* was successfully used by civilian and military flying schools, especially as a primary training plane. Its structural qualities and flying performances were confirmed by the long-distance flight

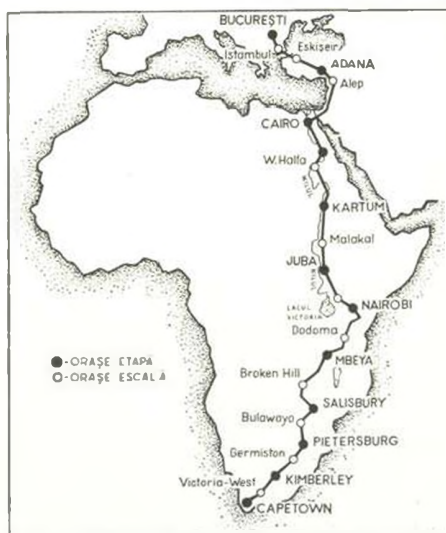

Map of the Bucharest-Capetown route.

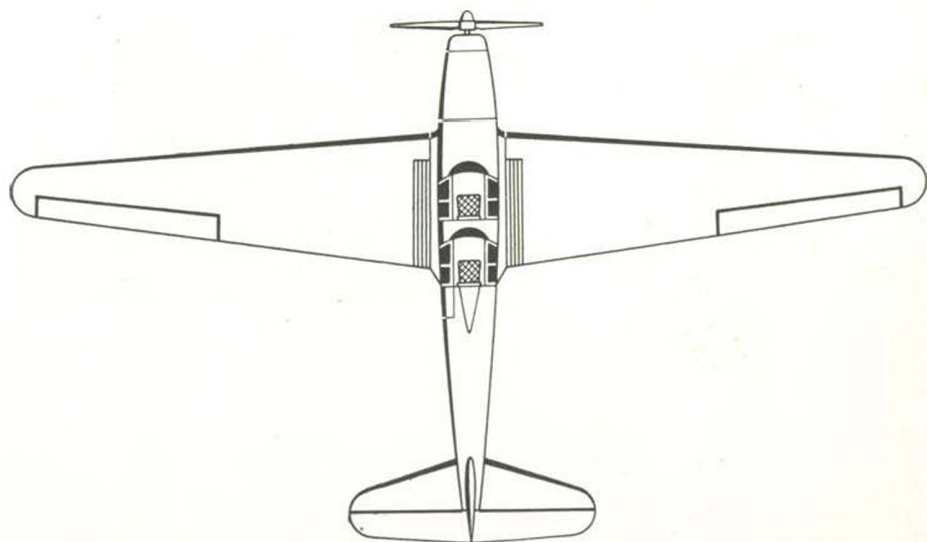



The crews of the I.C.A.R. formation, immediately after the landing at Capetown.



BUCAREST - LE CAP  
ET RETOUR

## LE RAID DE TROIS AVIONS ROUMAINS

...qui ont couvert 30,000  
kilomètres sans atterrissement

Il y a presque exactement deux ans, trois tout petits avions se posèrent à Alindia. Ils avaient été poursuivis à bord, cinq officiers et un mécanicien, qui étaient tous de retour sans se souvenir de ce qu'ils avaient fait. C'était pour être lancés dans un des avions qui, lors de 110 ou 120 kilomètres

Press clipping from an Egyptian paper featuring the Romanian flight from Bucharest to Capetown.

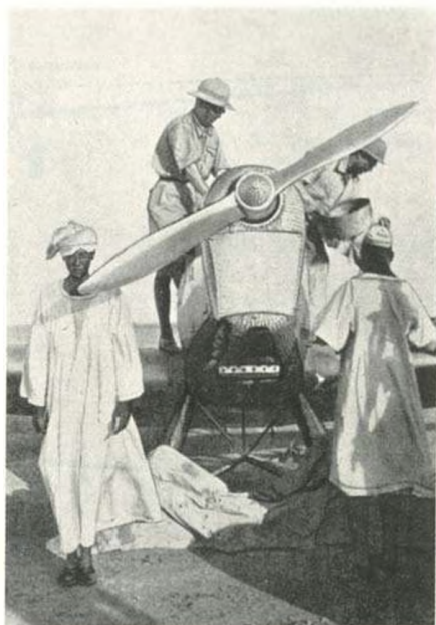

A. Cernescu and M. Pantazi refuelling during the stop-over at Wadi-Halfa, on the fourth stage of the long-distance flight.

carried out by three I.C.A.R.-Universal planes in 1935 from Bucharest to Capetown (11,500 km) in 73 hours and 5 min of effective flying time. The return flight covered a total distance of 23,000 km in 27 days, actual flying time totalling 149 hours and 10 minutes. The three crews included Major Mihail Pantazi, Major Alexandru Cernescu, Major Gheorghe Davidescu,



Last moments  
before  
the take off  
to Bucharest  
(Raid Cape  
Town).



Lt. Colonel *Gheorghe Jienescu*, Captain *Gheorghe Olteanu* and pilot-mechanic *Anton Stengher*. Three mass-produced planes belonging to the squadrons of the Air Force schools were chosen for this difficult long-distance flight, full of meteorological difficulties resulting from the variety of the regions that had to be covered. The factory which had built the planes made several improvements and changes, among them a modification in the fuel tanks, increasing flight endurance from three hours to eight hours and a half, and the provision of specific equipment needed for the flight over the African continent. Although the weight of the aircraft was thereby increased by more than 150 kg, the flight performances were not affected.

The long-distance flight of the three *I.C.A.R.-Universal* planes was fully successful, representing one of the most notable achievements of Romanian-made aircraft.

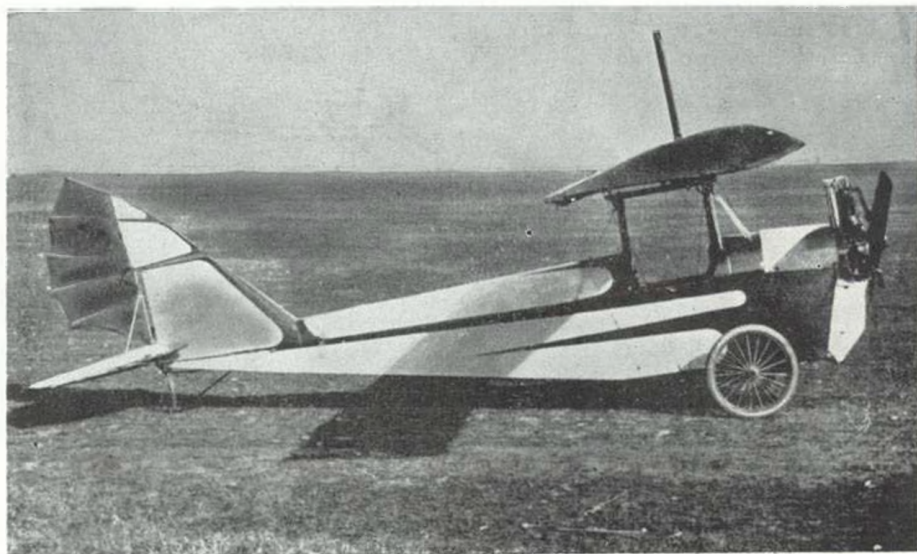

### R.M.-5 (1935)

Touring aircraft

Span 8.00 m, length 5.60 m, wing area 10.00 sq m, empty weight 120 kg, payload 80 kg, total weight 200 kg, 30-HP Anzani engine, maximum speed 120 km/h, minimum speed 50 km/h.

A single-seater plane, the *R.M.-5* was designed and built by Eng. *Radu Manicatide* as a light touring aircraft. It was a high-wing monoplane entirely made of timber. The wings and tail unit were covered by fabric and the fuselage by veneer.

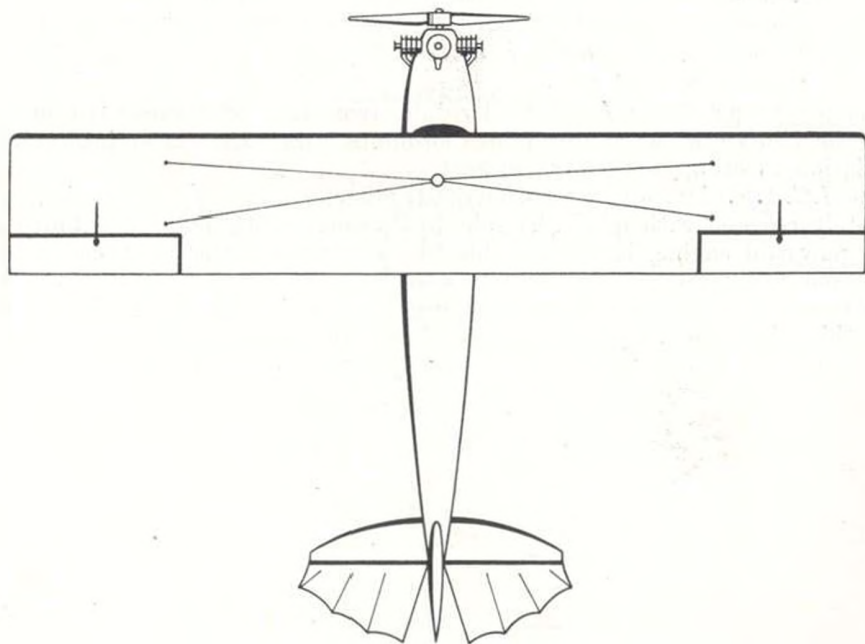
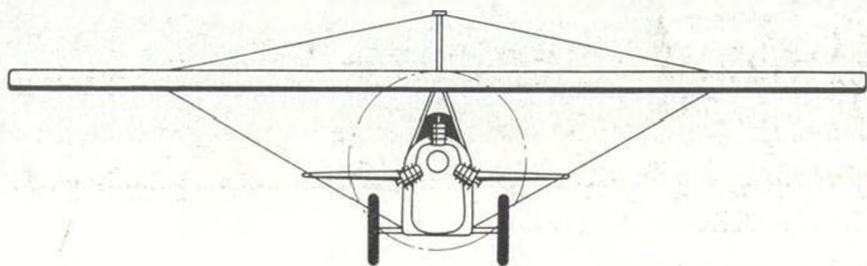
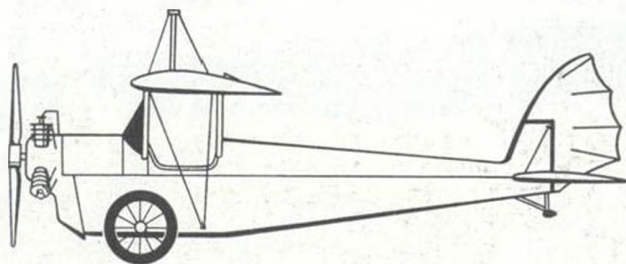



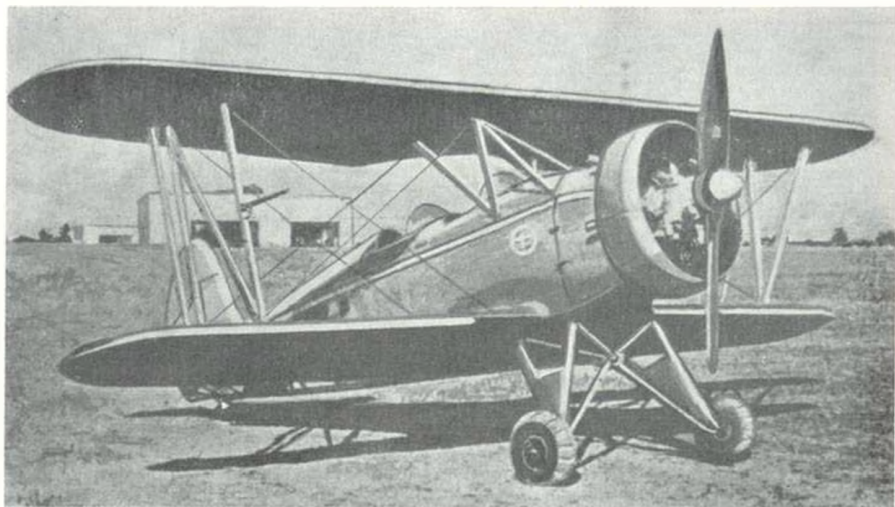

### I.C.A.R.-ACROBATIC (1935)

Aerobatic training aircraft

Span 8.40 m, length 8.50 m, height 2.60 m, wing area 20.22 sq m, 225-HP Siddeley Linx Mk4 engine, maximum speed 215 km/h, minimum speed 85 km/h, climb to 1,000 m 2 min.

The prototype of the *I.C.A.R.-Acrobatic* two-seater was presented in 1936 by the well-known aerobatics pilot *Constantin Cantacuzino* at an international aviation meeting at Băneasa airport.

The *I.C.A.R.-Acrobatic* was of mixed (timber and metal) construction, completely covered with fabric. Thanks to its outstanding manoeuvrability and its powerful engine, it was capable of carrying out the most complicated aerobatics figures.

Although its features and performances placed it among the best planes of this kind, the *I.C.A.R.-Acrobatic* was never mass-produced.

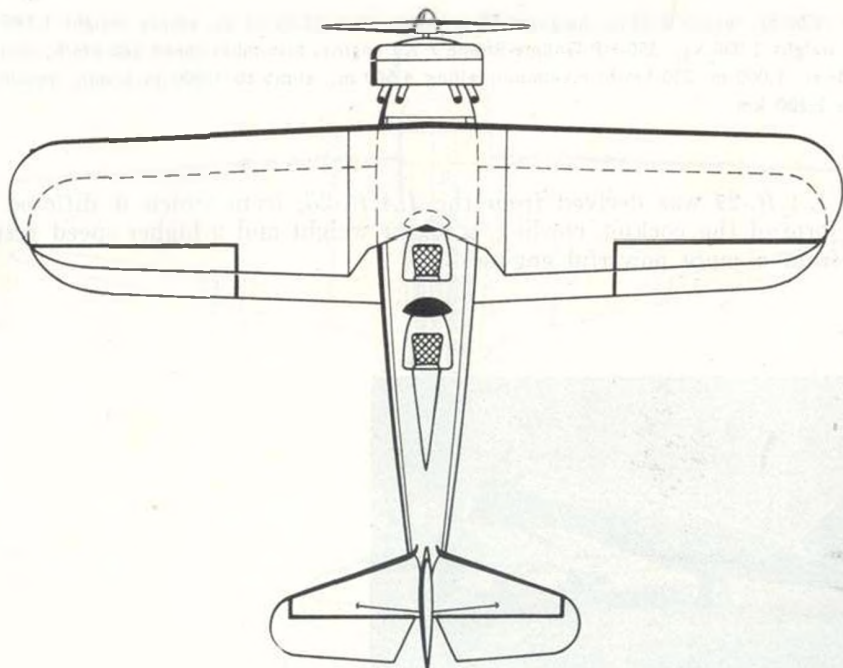
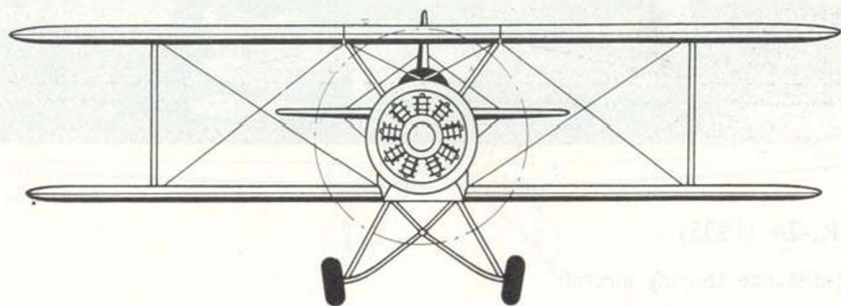
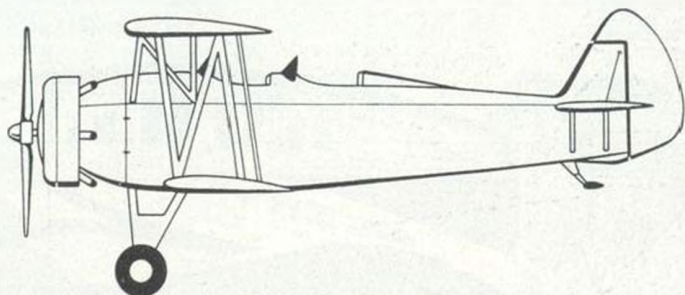

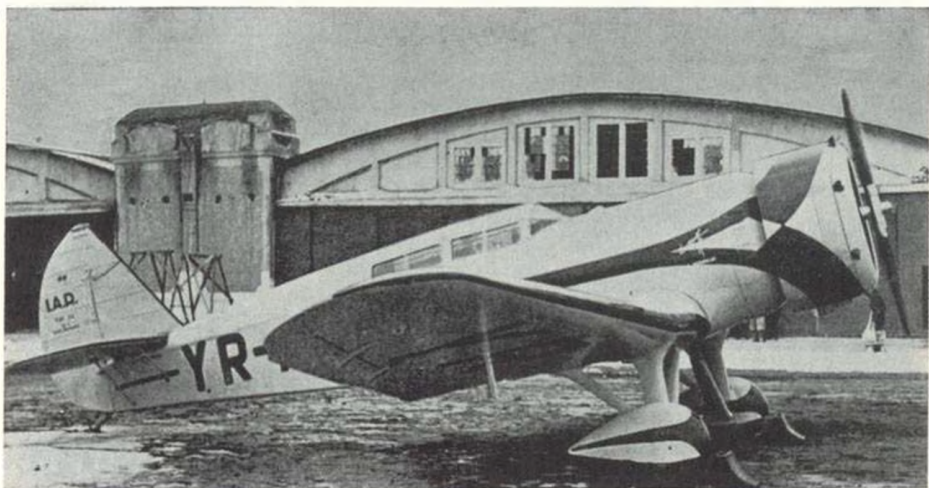

### I.A.R.-24 (1935)

Long-distance touring aircraft

Span 12.00 m, length 8.35 m, height 2.70 m, wing area 22.30 sq m, empty weight 1,180 kg, total weight 2,030 kg, 350-HP Gnôme-Rhône 7 Kd engine, maximum speed 280 km/h, cruising speed at 1,000 m 230 km/h, maximum ceiling 4,500 m, climb to 1,000 m 5 min, maximum range 2,300 km.

The *I.A.R.-24* was derived from the *I.A.R.-23*, from which it differed by the form of the cockpit cowling, a bigger weight and a higher speed resulting from a more powerful engine.

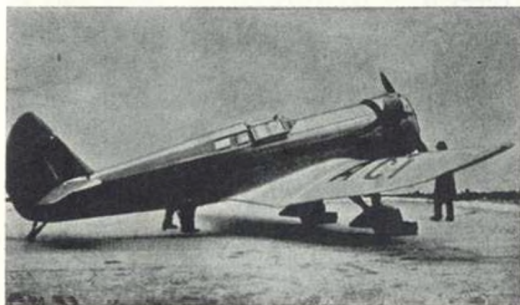



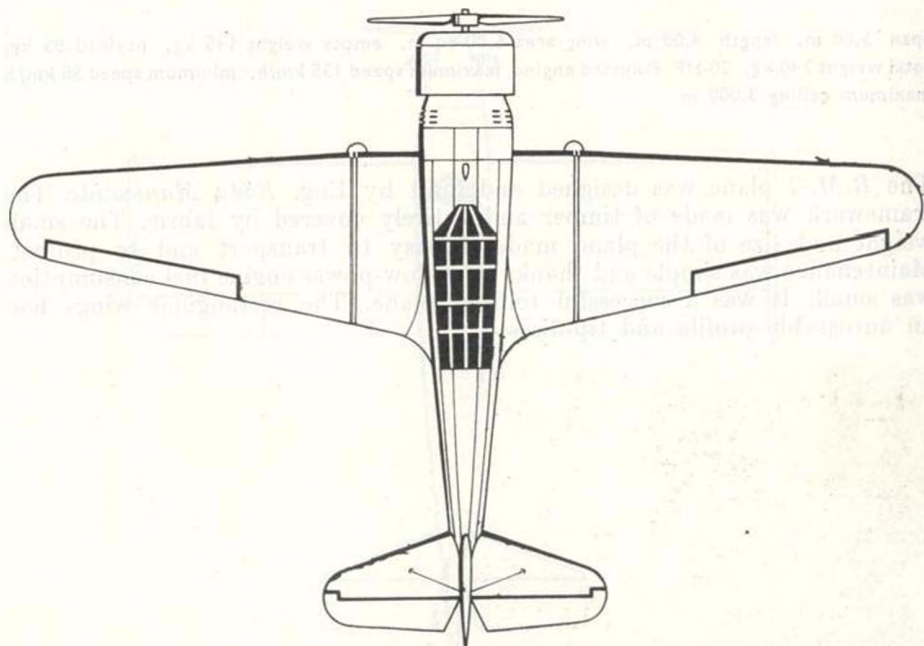
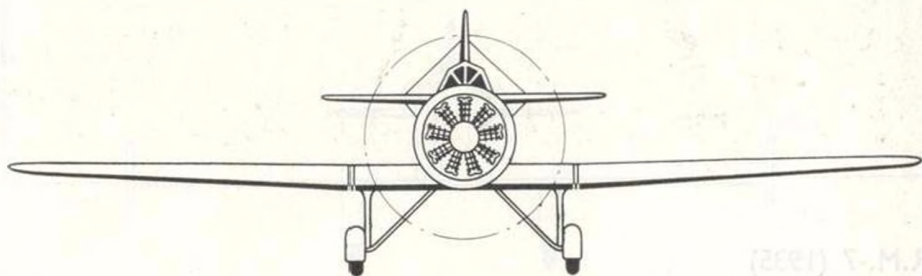
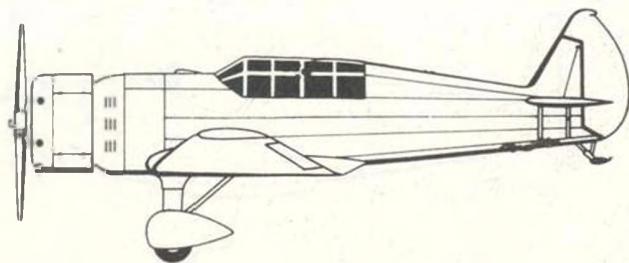

I. A. R.-24 (1925)



### R.M.-7 (1935)

Single-seater light touring aircraft

Span 5.00 m, length 4.00 m, wing area 6.00 sq m, empty weight 145 kg, payload 95 kg, total weight 240 kg, 20-HP Poincard engine, maximum speed 135 km/h, minimum speed 58 km/h maximum ceiling 3,000 m.

The *R.M.-7* plane was designed and built by Eng. *Radu Manicatide*. The framework was made of timber and entirely covered by fabric. The small weight and size of the plane made it easy to transport and to protect. Maintenance was simple and thanks to its low-power engine fuel consumption was small. It was a successful touring plane. The rectangular wings had an autostable profile and tip-discs.

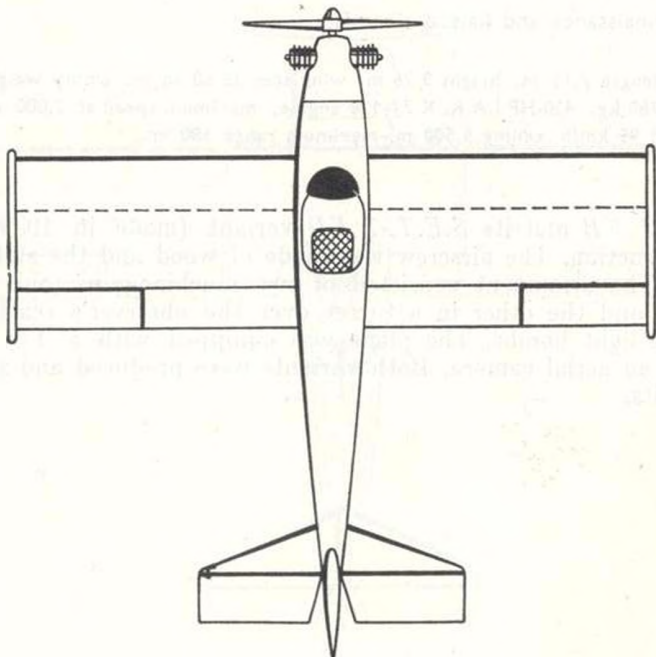
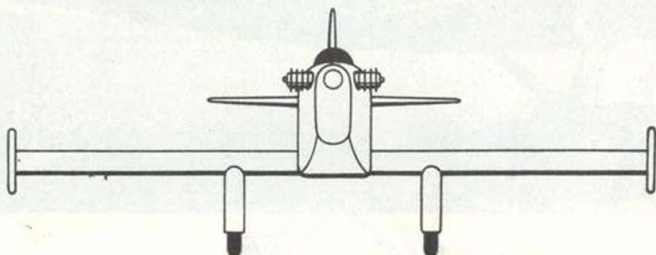
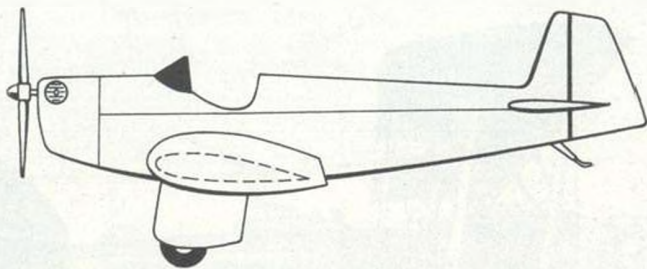





### S.E.T.-7 KB and S.E.T.-7 KD (1935)

Tactical reconnaissance and liaison aircraft

Span 9.80 m, length 7.15 m, height 3.26 m, wing area 26.60 sq m, empty weight 1,115 kg, total weight 1,780 kg, 420-HP I.A.R. K 7-120 engine, maximum speed at 2,000 m 250 km/h, minimum speed 95 km/h, ceiling 5,500 m, maximum range 580 km.

The *S.E.T.-7 KB* and its *S.E.T.-7 KD* variant (made in 1939) were of mixed construction. The airscrew was made of wood and the stabilizer was adjustable. The armament consisted of two machine-guns (one fixed, forward firing, and the other in a turret over the observer's seat), and two racks for 24 light bombs. The plane was equipped with a T/R radio set and carried an aerial camera. Both variants were produced and supplied to military units.

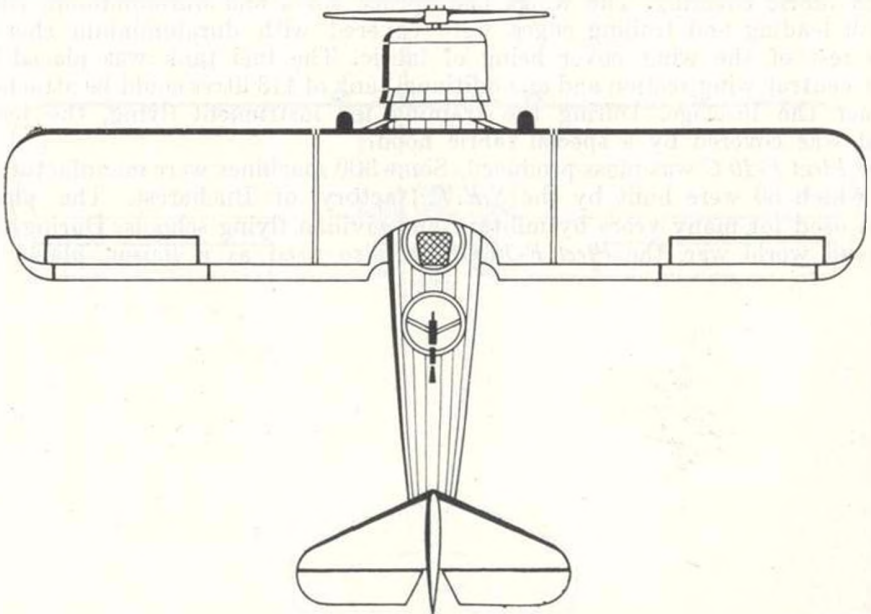
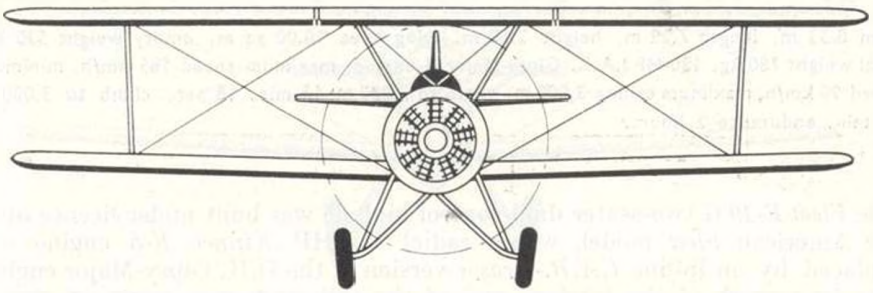
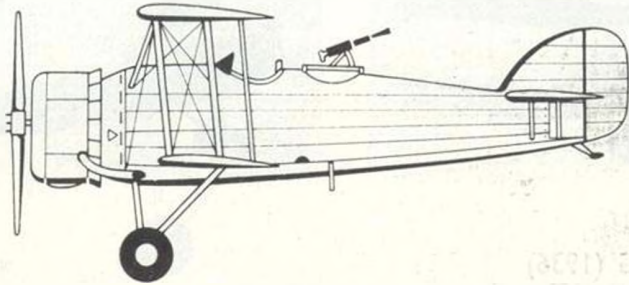



## FLEET F-10 G (1936)

Primary and basic training, and liaison aircraft\*

Span 8.53 m, length 7.29 m, height 2.50 m, wing area 18.00 sq m, empty weight 530 kg, total weight 780 kg, 130-HP I.A.R. Gipsy-Major 4 engine, maximum speed 185 km/h, minimum speed 90 km/h, maximum ceiling 3,000 m, climb to 2,000 m 13 min. 18 sec, climb to 3,000 m 22 min, endurance 2 hours.

The *Fleet F-10 G* two-seater dual-control biplane was built under licence after the American *Fleet* model, whose radial 115-HP *Kinner K-5* engine was replaced by an in-line *I.A.R.-Braşov* version of the D.H. Gipsy-Major engine. The framework of the fuselage and of the tail unit was made of metal, with fabric covering. The wings had spruce spars and duraluminium ribs. Both leading and trailing edges were covered with duraluminium sheets, the rest of the wing cover being of fabric. The fuel tank was placed in the central wing section and an additional tank of 113 litres could be attached under the fuselage. During the training for instrument flying, the back seat was covered by a special fabric hood.

The *Fleet F-10 G* was mass-produced. Some 300 machines were manufactured, of which 80 were built by the *S.E.T.* factory of Bucharest. The plane was used for many years by military and civilian flying schools. During the second world war, the *Fleet F-10 G* was also used as a liaison plane.

\* Built under licence by *I.A.R.* of Braşov and *S.E.T.* of Bucharest.



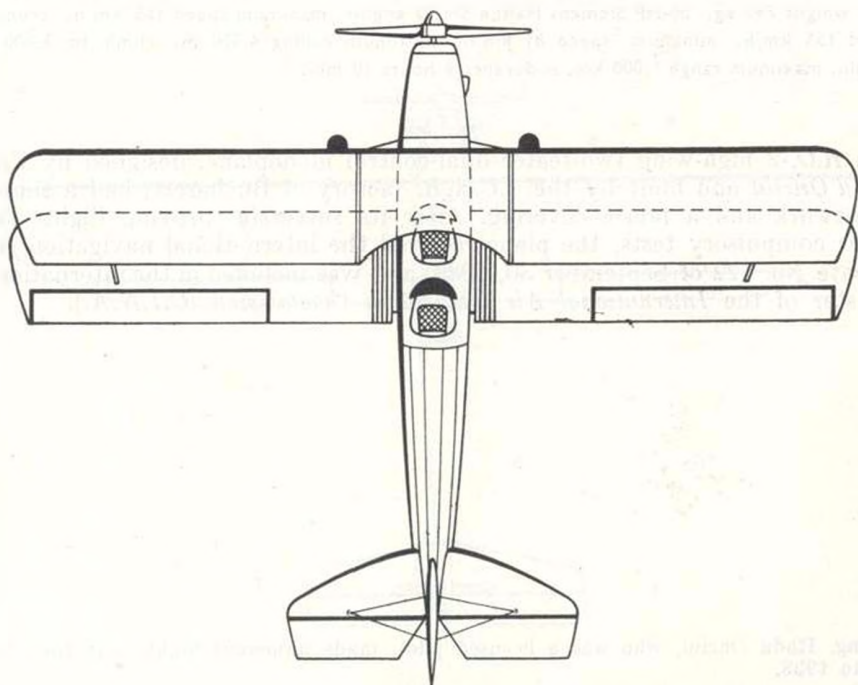
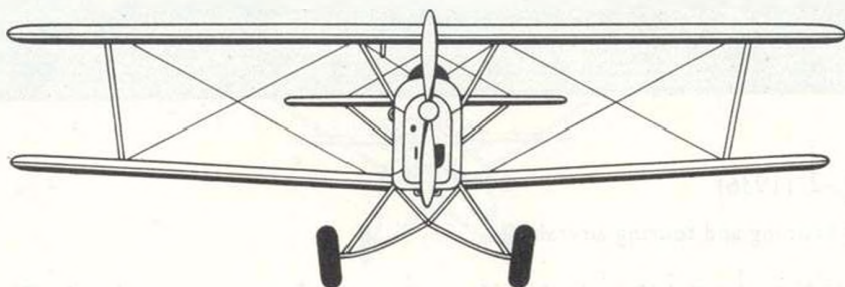
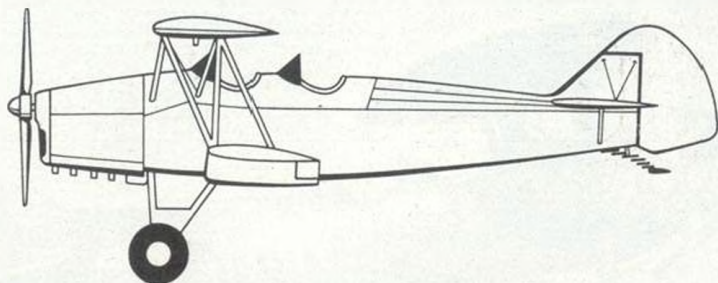

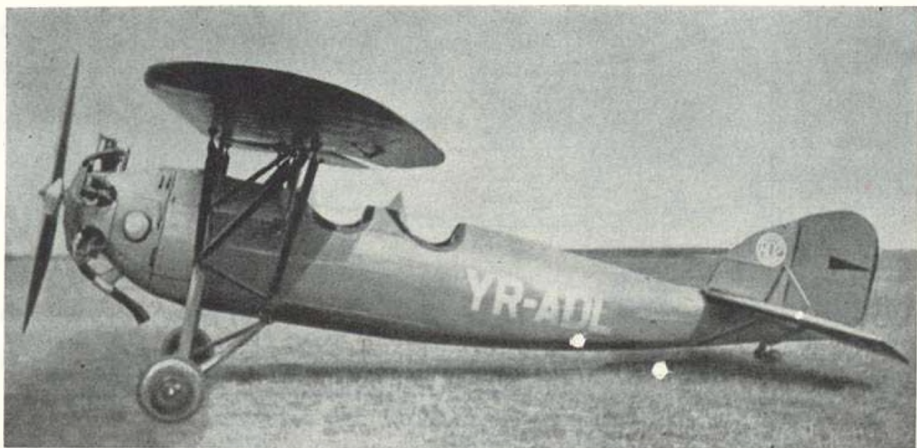

### R.O.-2 (1936)

Basic training and touring aircraft\*

Span 10.96 m, length 6.68 m, height 2.30 m, wing area 15.00 sq m, empty weight 463 kg, total weight 740 kg, 80-HP Siemens Halske SH 13 engine, maximum speed 165 km/h, cruising speed 155 km/h, minimum speed 81 km/h, maximum ceiling 4,500 m, climb to 2,000 m 12 min, maximum range 1,000 km, endurance 6 hours 30 min.

The *R.O.-2* high-wing two-seater dual-control monoplane, designed by Eng. *Radu Onciul* and built by the *I.C.A.R.* factory of Bucharest, had a timber framework and a fabric covering. After its successful proving flights and other compulsory tests, the plane received the international navigation certificate No. 122 of September 30, 1936, and was included in the international register of the *International Air Navigation Commission (C.I.N.A.)*.

\* Eng. *Radu Onciul*, who was a licensed pilot, made numerous flights with the *R.O.-2* up to 1938.

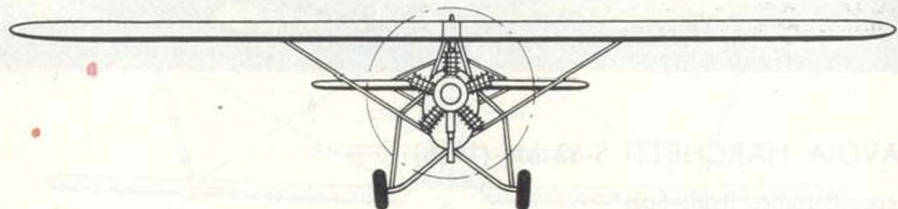
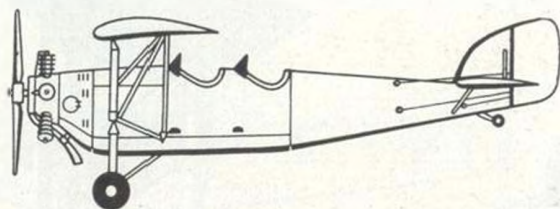

Savoia Marchetti S-55  
Record: 10,000 ft. in 10 min. 1935  
Speed: 100 mph. Altitude: 10,000 ft. in 10 min. 1935  
Weight: 1,500 lbs. Max. speed: 100 mph. Max. altitude: 10,000 ft. in 10 min. 1935

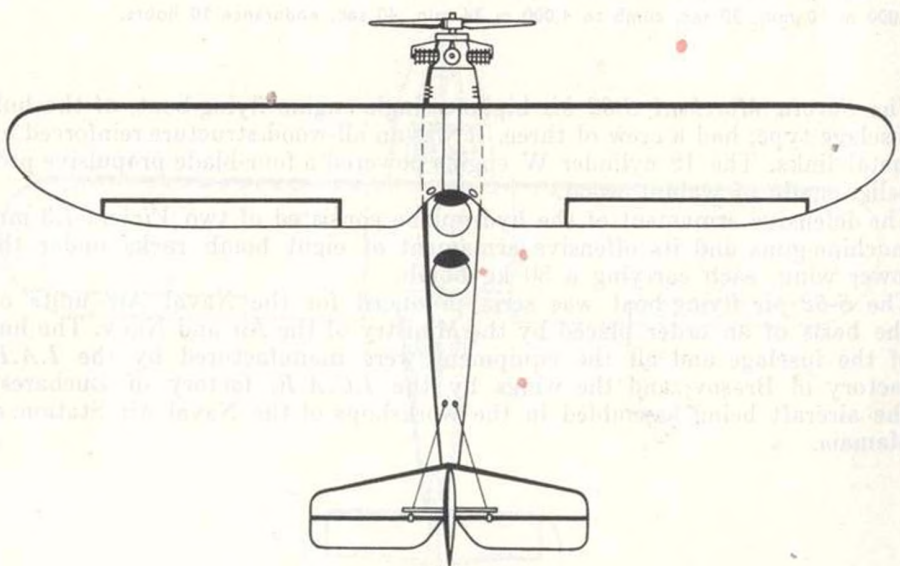

\* Built under license after the Italian first post-war airplane.



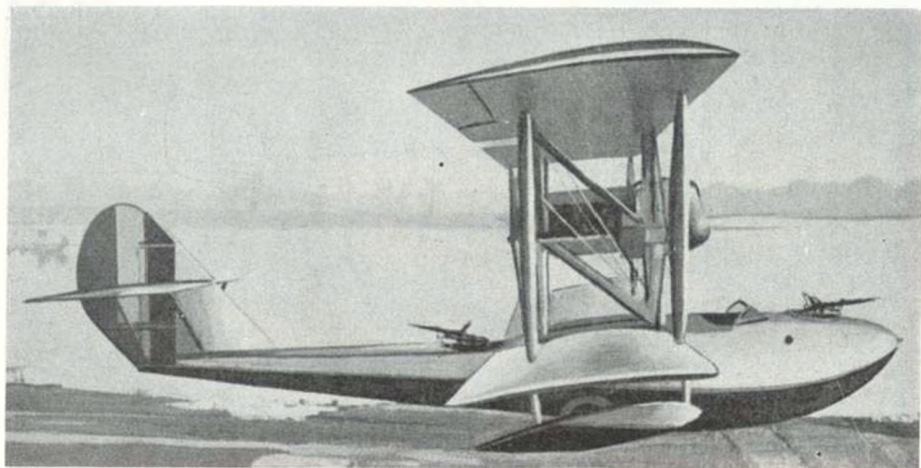

## SAVOIA MARCHETTI S-62 bis (1936)

Reconnaissance flying-boat\*

Span 16.66 m, length 12.26 m, height 4.19 m, wing area 60.52 sq m, empty weight 2,650 kg, total weight 4,150 kg, 750-HP Isotta Fraschini-Asso engine, maximum speed 218 km/h, cruising speed 180 km/h, minimum speed 98 km/h, maximum ceiling 4,500 m, climb to 2,000 m 10 min. 30 sec, climb to 4,000 m 34 min. 40 sec, endurance 10 hours.

The *Savoia Marchetti S-62 bis* biplane single-engine flying-boat, of the hull fuselage type, had a crew of three. It was an all-wood structure reinforced by metal links. The 18 cylinder W engine powered a four-blade propulsive propeller made of walnut wood.

The defensive armament of the hydroplane consisted of two *Vickers* 7.3 mm machine-guns and its offensive armament of eight bomb racks under the lower wing, each carrying a 50 kg bomb.

The *S-62 bis* flying-boat was serial-produced for the Naval Air units on the basis of an order placed by the Ministry of the Air and Navy. The hull of the fuselage and all the equipment were manufactured by the *I.A.R.* factory of Braşov, and the wings by the *I.C.A.R.* factory of Bucharest, the aircraft being assembled in the workshops of the Naval Air Station of Mamaia.

\* Built under licence after the Italian flying-boat of the same name.

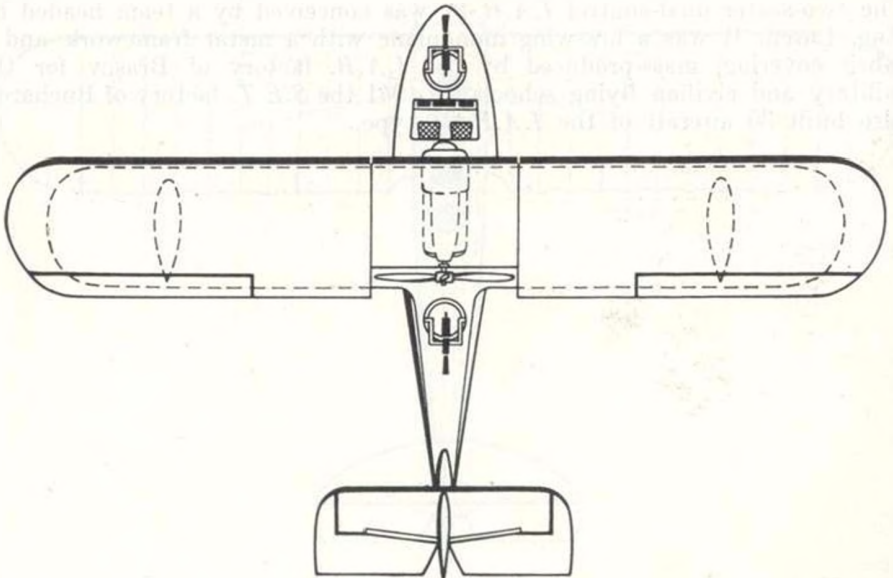
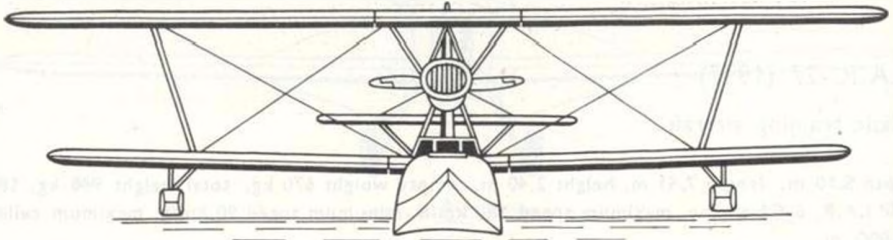
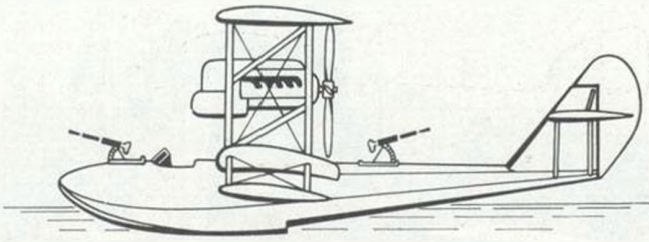



### I.A.R.-27 (1937)

Basic training aircraft

Span 9.10 m, length 7.41 m, height 2.40 m, empty weight 670 kg, total weight 948 kg, 180-HP I.A.R. 6 G1 engine, maximum speed 180 km/h, minimum speed 90 km/h, maximum ceiling 5,000 m.

The two-seater dual-control *I.A.R.-27* was conceived by a team headed by Eng. Lascu. It was a low-wing monoplane with a metal framework and a fabric covering, mass-produced by the *I.A.R.* factory of Braşov for the military and civilian flying schools. In 1941 the *S.E.T.* factory of Bucharest also built 30 aircraft of the *I.A.R.-27* type.



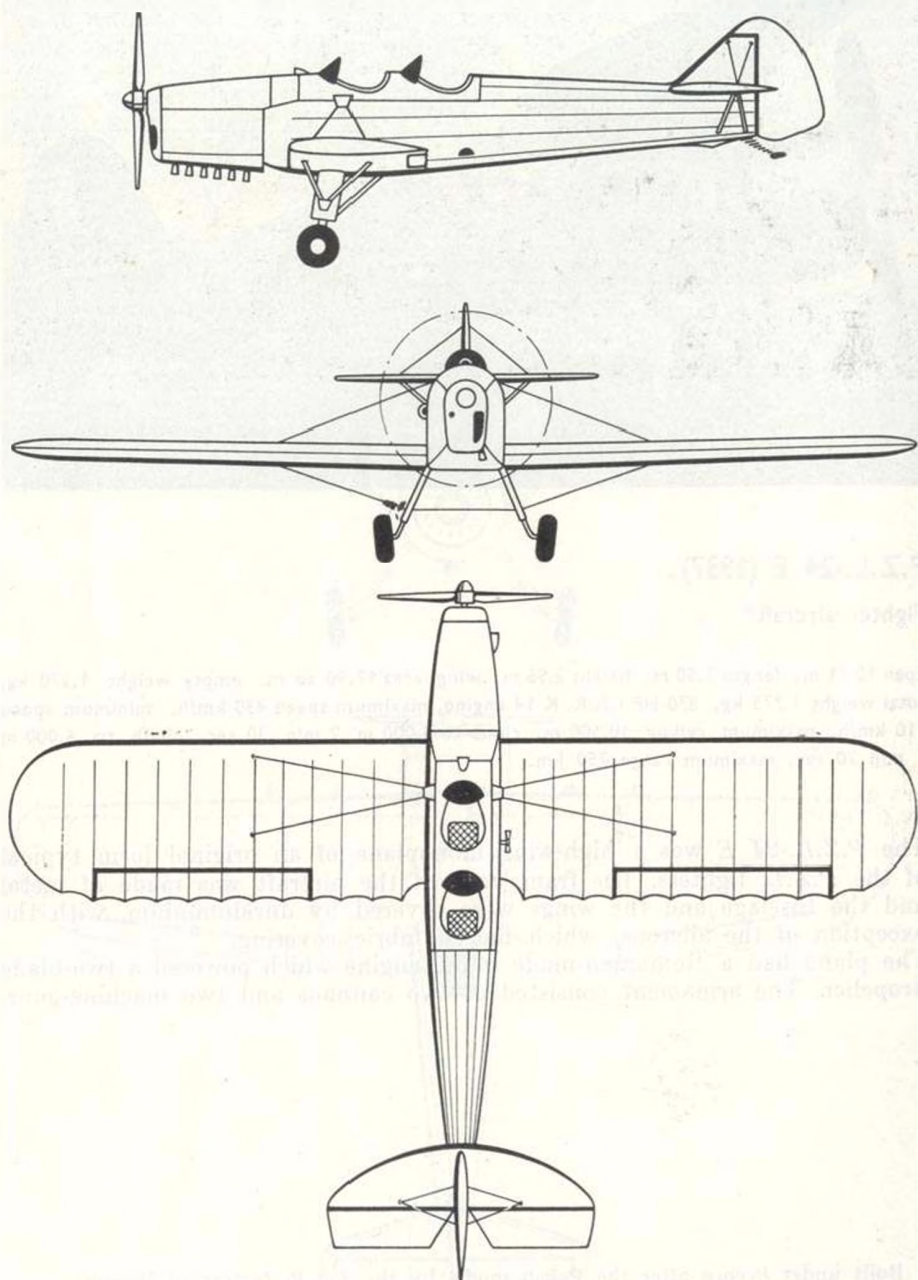

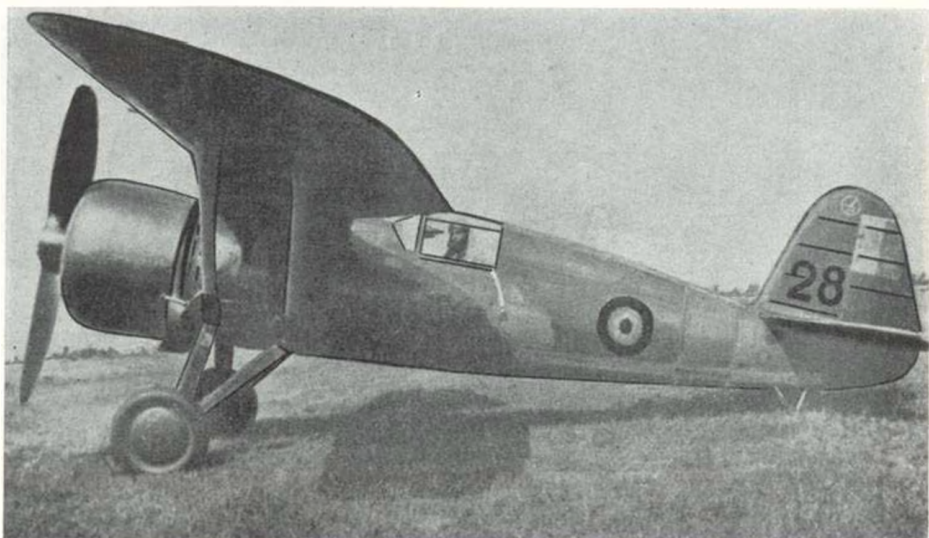

### P.Z.L.-24 E (1937)

Fighter aircraft\*

Span 10.71 m, length 7.50 m, height 2.96 m, wing area 17.90 sq m, empty weight 1,270 kg, total weight 1,775 kg, 870-HP I.A.R. K 14 engine, maximum speed 430 km/h, minimum speed 110 km/h, maximum ceiling 10,500 m, climb to 2,000 m 2 min 30 sec, climb to 6,000 m 7 min 20 sec, maximum range 750 km.

The *P.Z.L.-24 E* was a high-wing monoplane of an original form typical of the *P.Z.L.* fighters. The framework of the aircraft was made of metal and the fuselage and the wings were covered by duraluminium, with the exception of the ailerons, which had a fabric covering.

The plane had a Romanian-made radial engine which powered a two-blade propeller. The armament consisted of two cannons and two machine-guns.

\* Built under licence after the Polish model by the *I.A.R.* factory of Braşov.

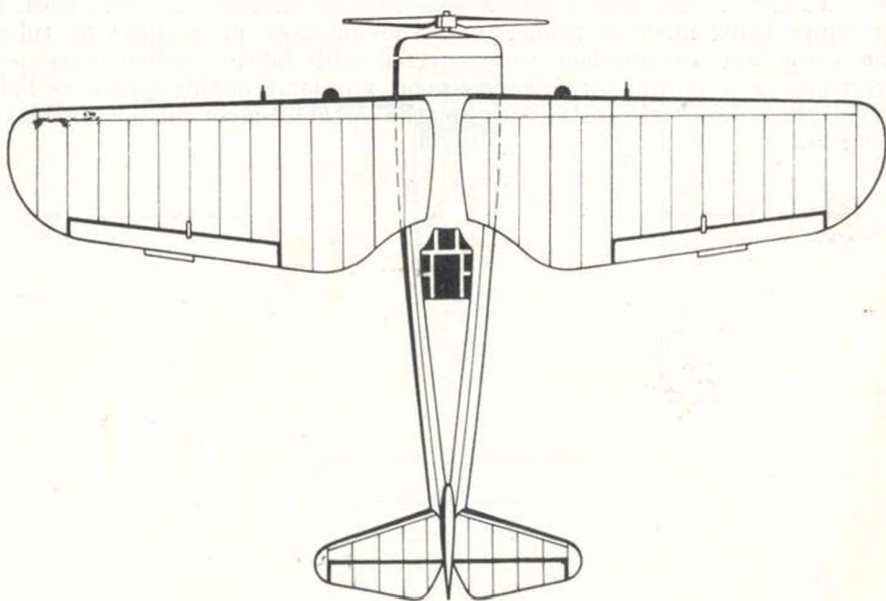
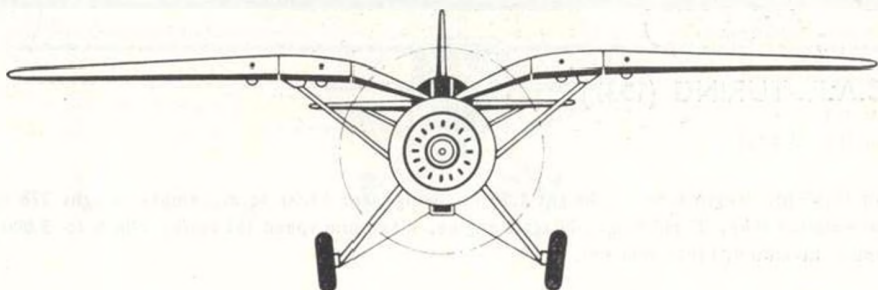
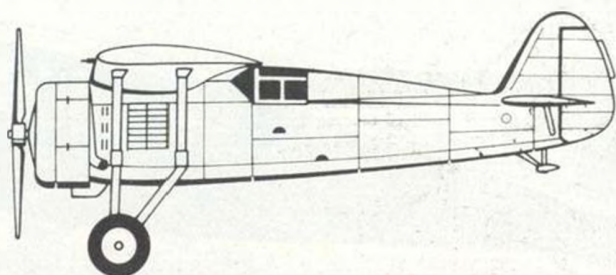





### I.C.A.R.-TURING (1937)

Touring aircraft

Span 10.50 m, length 6.40 m, height 1.91 m, wing area 14.00 sq m, empty weight 378 kg, total weight 600 kg, 90-HP Pobjoy-Niagara engine, maximum speed 182 km/h, climb to 3,000 m 16 min, maximum range 800 km.

The *I.C.A.R.-Turing* was a mixed construction aircraft, the framework of the wings being made of timber and the fuselage of aluminium tubes. The wings and the fuselage were covered with fabric. Although its performances as a touring aircraft were good, no planes of this type were built except those for static tests and for the establishment of airworthiness documents.

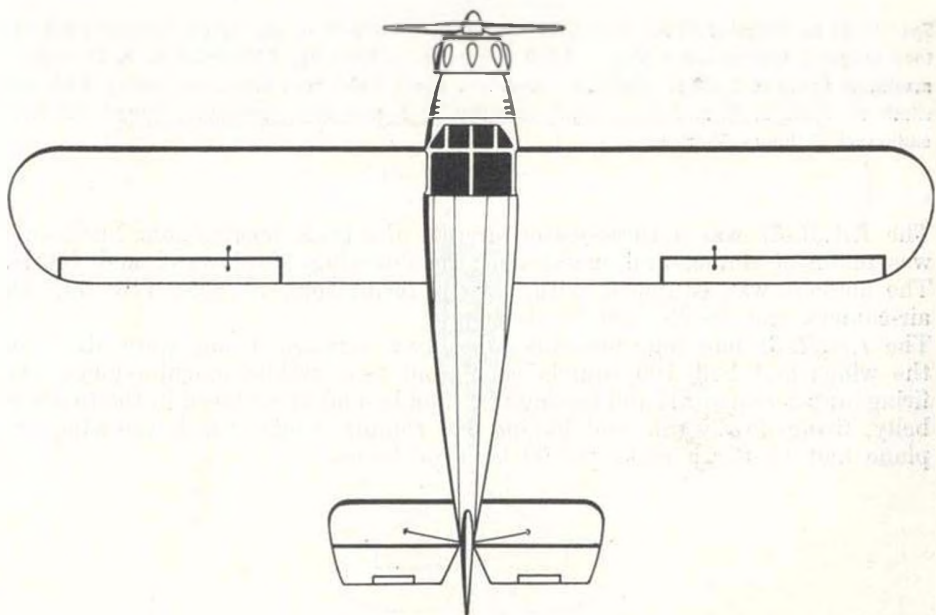
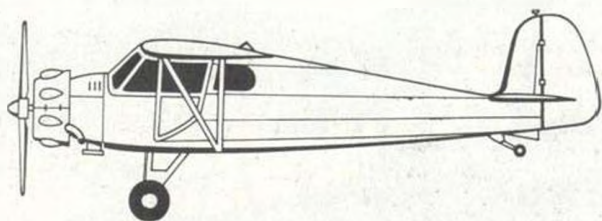



### I.A.R.-37 (1937)

Reconnaissance and light bombing aircraft

Span 12.22 m, length 9.50 m, height 3.97 m, wing area 35.70 sq m, empty weight 2,219 kg, total weight: reconnaissance plane — 3,060 kg, bomber — 3,459 kg, 870-HP I.A.R. K 14 engine, maximum speed at 3,200 m 335 km/h, minimum speed 140 km/h, maximum ceiling 8,000 m, climb to 2,000 m 4 min 10 s, climb to 4,000 m 8 min 30 s, maximum range 650 km, endurance 2 hours 30 min.

The *I.A.R.-37* was a three-seater aircraft of mixed construction. The frame was made of timber and metal and the covering of plywood and fabric. The aircraft was equipped with oxygen respirators, a radio T/R set, an air-camera and an *Estopey* bomb-sight.

The *I.A.R.-37* had four machine-guns: two forward firing were fixed in the wings and had 700 rounds each, and two mobile machine-guns, one firing upper-rearwards and having 600 rounds, and one, placed in the fuselage belly, firing downwards and having 300 rounds. Under the lower wing the plane had 12 bomb racks for 50 kg type bombs.



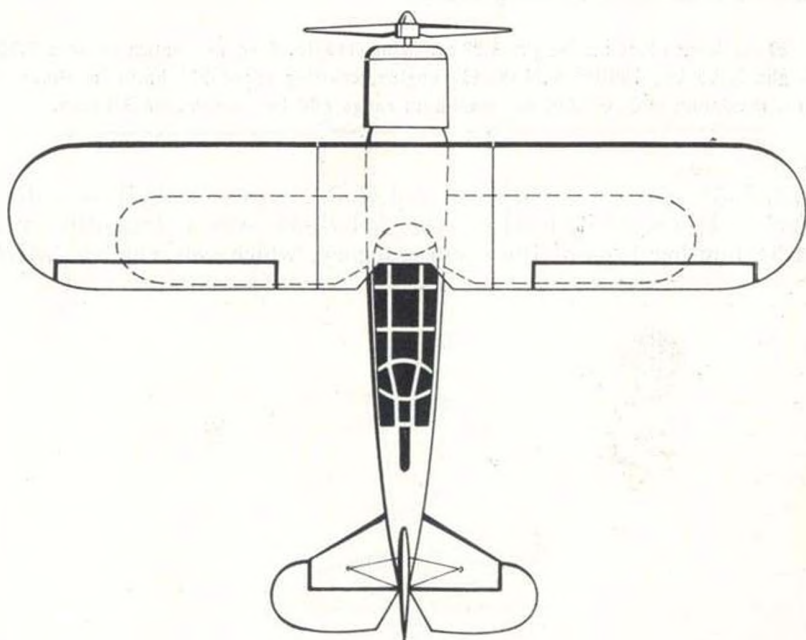
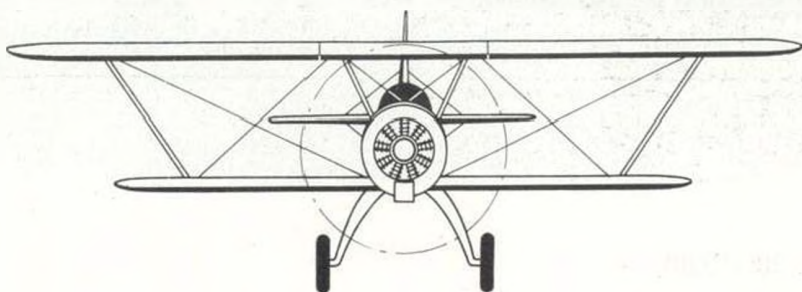
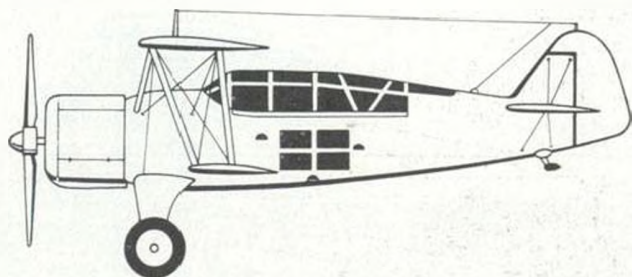

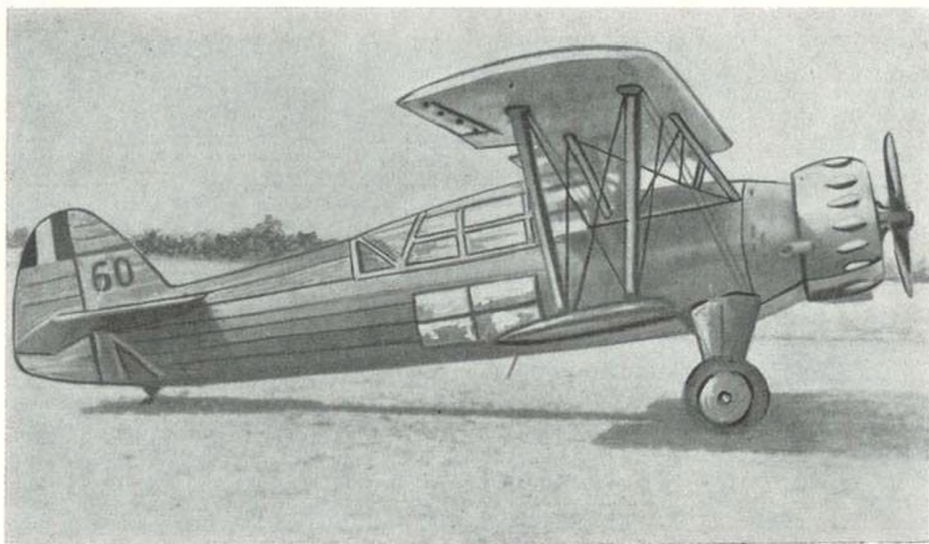

### I.A.R.-38 (1938)

Reconnaissance and light bombing aircraft

Span 13.20 m, length 9.56 m, height 3.80 m, wing area 40.30 sq m, empty weight 2,300 kg, total weight 3,100 kg, 700-HP B.M.W.-132 engine, cruising speed 220 km/h, minimum speed 120 km/h, maximum ceiling 7,000 m, maximum range 680 km, endurance 3 hours.

The *I.A.R.-38* was similar to the *I.A.R.-37* from which it was derived. Manufactured in a limited series, the *I.A.R.-38* was a transition variant leading to another type of the same category, which was named *I.A.R.-39*.

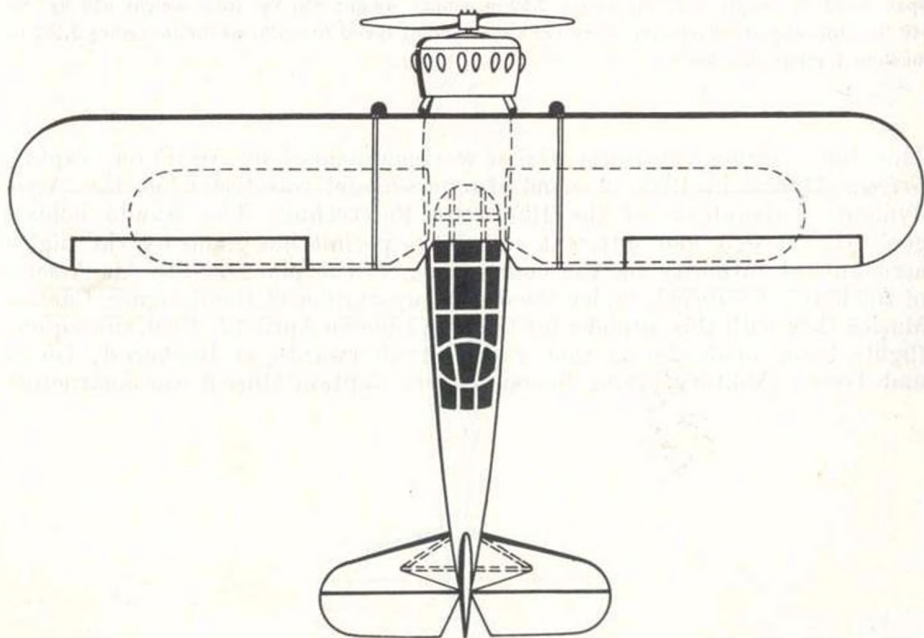
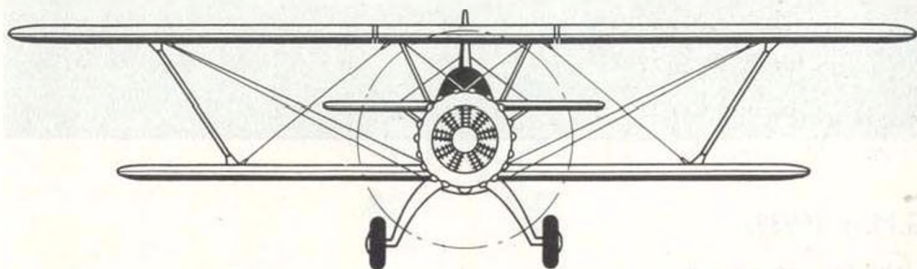
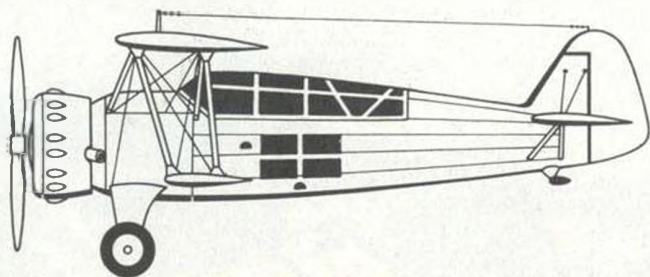





### G.M.-1 (1939)

Light touring aircraft

Span 10.00 m, length 6.30 m, height 2.50 m, empty weight 450 kg, total weight 610 kg, 40-HP Salmson engine, maximum speed 123 km/h, landing speed 70 km/h, maximum ceiling 3,500 m, maximum range 300 km.

This light touring two-seater design was commenced by Air Force captain *Grigore Mușică* in 1935. A wind tunnel model was tested in the Aerodynamic Laboratory of the Bucharest Polytechnic. The results holding good the design and adjacent calculus, a permit has given by the higher aeronautical authority for the construction of the plane at the Air Arsenal of Bucharest-Cotroceni, under the direct supervision of the designer. Captain *Mușică* flew with this airplane for the first time on April 12, 1939, subsequent flights being made during that year and afterwards, at Bucharest, Buzău and Tecuci (Military Flying Schools where Captain *Mușică* was instructor).

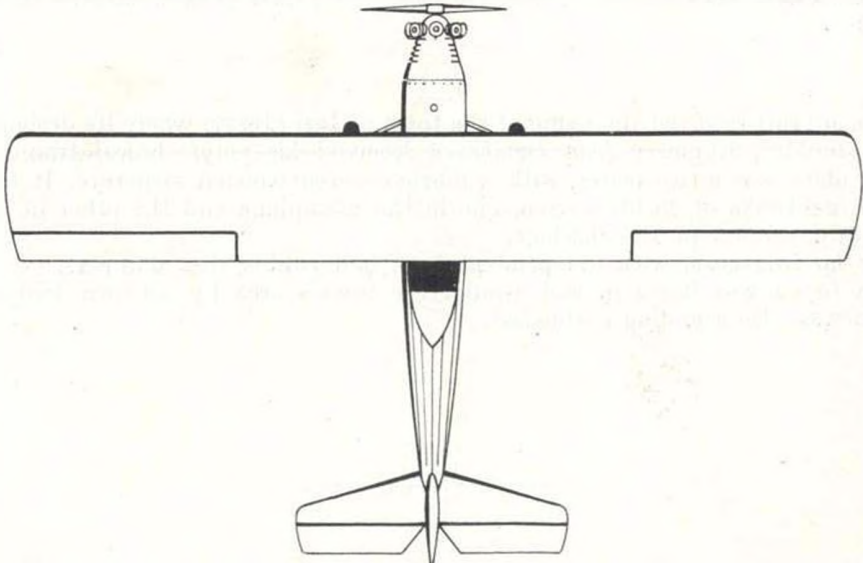
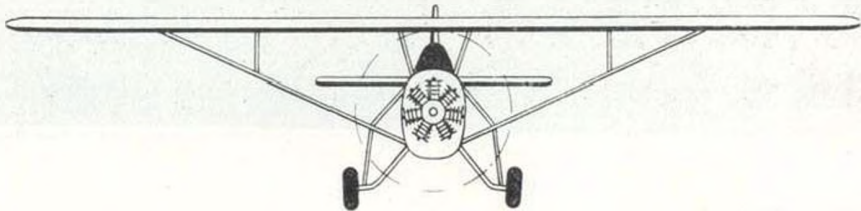



### IAȘI-1 (1939)

Light touring aircraft

Span 9.82 m, length 6.20, empty weight 205 kg, total weight 365 kg, 40-HP Salmson engine maximum speed 150 km/h, cruising speed 130 km/h, landing speed 60 km/h, maximum ceiling 4,000 m.

This aircraft received the name of the town of Iași (Jassy) where its designer and builder, Engineer *Ioan Dumbravă* received his polytechnical training. The plane was a two-seater, with a fabric-covered wooden structure. It had two fuel tanks of 35 litres each, one in the mainplane and the other in the forward section of the fuselage.

The landing gear, with independent legs, had rubber disc dampers.

The *Iași-1* was flown in and around the town's area by its own builder, who was also a gliding enthusiast.



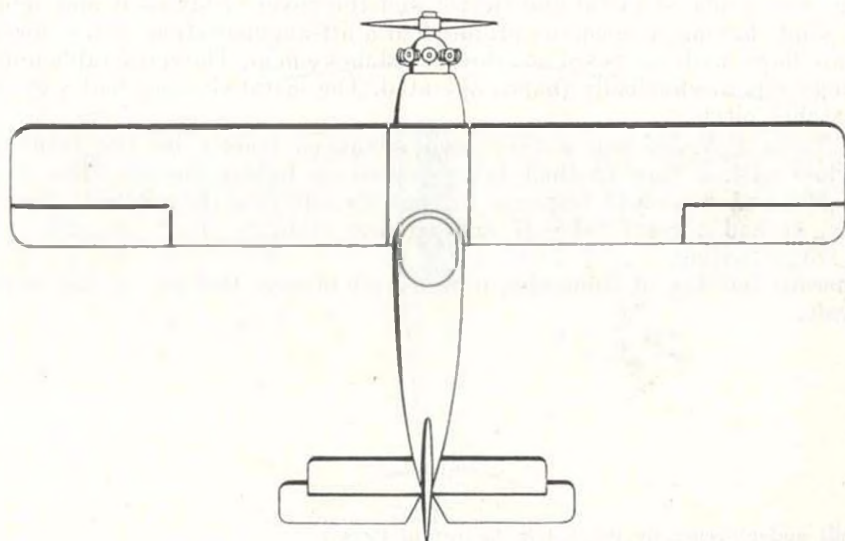
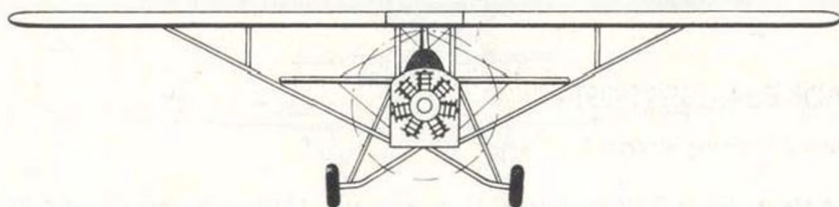
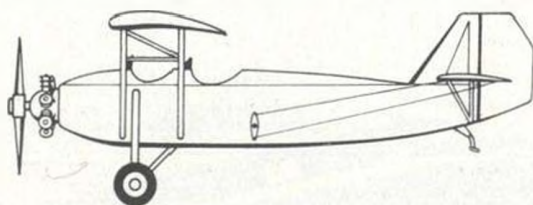

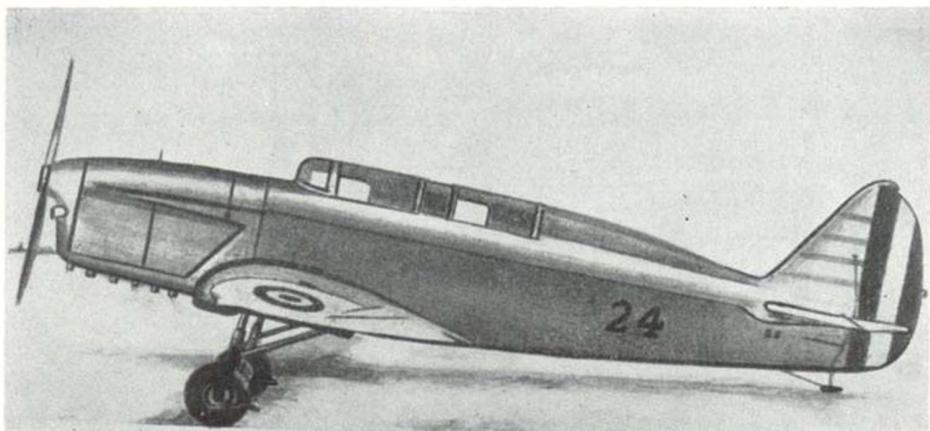

### NARDI F.N.-305 (1939)

Advanced training aircraft \*

Span 8.476 m, length 7.136 m, height 2.15 m, wing area 12.00 sq m, empty weight 700 kg, total weight 858 kg, 180-HP I.A.R. 6 G 1 engine, maximum speed 300 km/h, landing speed 140 km/h, climb to 5,000 m 23 min.

The *Nardi F.N.-305* was a two-seater dual-control low-wing monoplane. The frame was made of metal and timber and the cover of plywood and fabric. The wing, having a biconvex profile, had a lift-augmentation system formed of two flaps with rearward and downward movement. The retractable undercarriage was mechanically (hand) operated. The metal airscrew had a ground adjustable pitch.

The *Nardi F.N.-305* was a very good advanced trainer for the transition of pilots with a view to their being posted to fighter aircraft. The *Nardi F.N.-305* had a prompt response to controls, obliging the pilots to fly correctly. It had a great take-off and landing stability, both on glide path and when taxiing.

Numerous batches of Romanian military pilots were trained on this sturdy aircraft.

\* Built under licence by the I.A.R. factory of Braşov

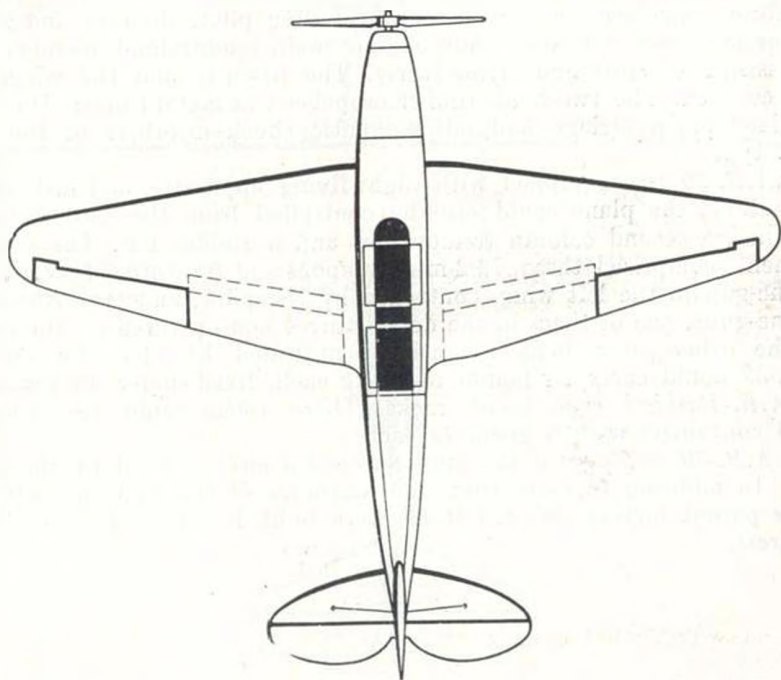
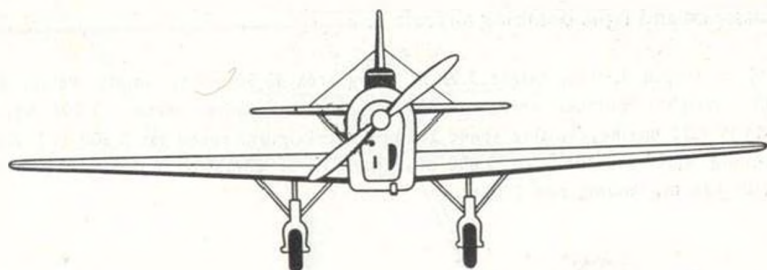
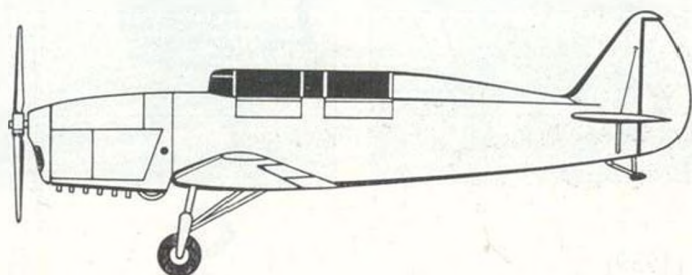





## I.A.R.-39 (1939)

Reconnaissance and light bombing aircraft

Span 13.10 m, length 9.60 m, height 3.99 m, wing area 40.30 sq m, empty weight 2,177 kg. Max. T.O. weight: bomber version 3,085 kg, reconnaissance version 3,007 kg, 870-HP I.A.R. K 14-IV C32 engine, cruising speed 295 km/h, maximum speed (at 3,500 m.) 336 km/h, service ceiling 8,000 m, climb to 3,000 m 5 min 32 s, climb to 6,000 m 12 min 21 s, take-off run 136 m, landing run 170 m.

The *I.A.R.-39* was a sesquiplane biplane. It was of mixed construction, with the structure made of timber and metal and the cover of plywood and fabric, conceived to carry a crew including pilot, observer and gunner. The fuselage had a frame made of four main longitudinal members with high resistance struts and flying wires. The fuselage and the wings were fabric covered. The two-blade timber propeller was metal tipped. The arched type fixed undercarriage had oil-pneumatic shock-absorbers of the *T.U.-I.A.R.* type.

The *I.A.R.-39* was equipped with night-flying apparatus and instruments. If necessary, the plane could also be controlled from the observer's seat which had a second column (removable) and a rudder bar. The defensive armament comprised three 7.92-mm weapons: a *Browning P.W.U.* fixed machine-gun in the left wing, controlled by the pilot, and two *Rheinmetall* machine-guns, one of them in the dorsal turret and operated by the gunner, and the other on a belly mounting, controlled by the observer. The *I.A.R.-39* could carry 24 bombs of 12 kg each, fixed under the lower wing in *I.A.R.-Barbieri* type bomb racks. These racks could also carry 24 special containers with 6 grenades each.

The *I.A.R.-39* was one of the most successful aircraft built by the Braşov works. In addition to more than 100 machines of this type manufactured by the parent factory, 96 *I.A.R.-39* were built by the *S.E.T.* factory of Bucharest.

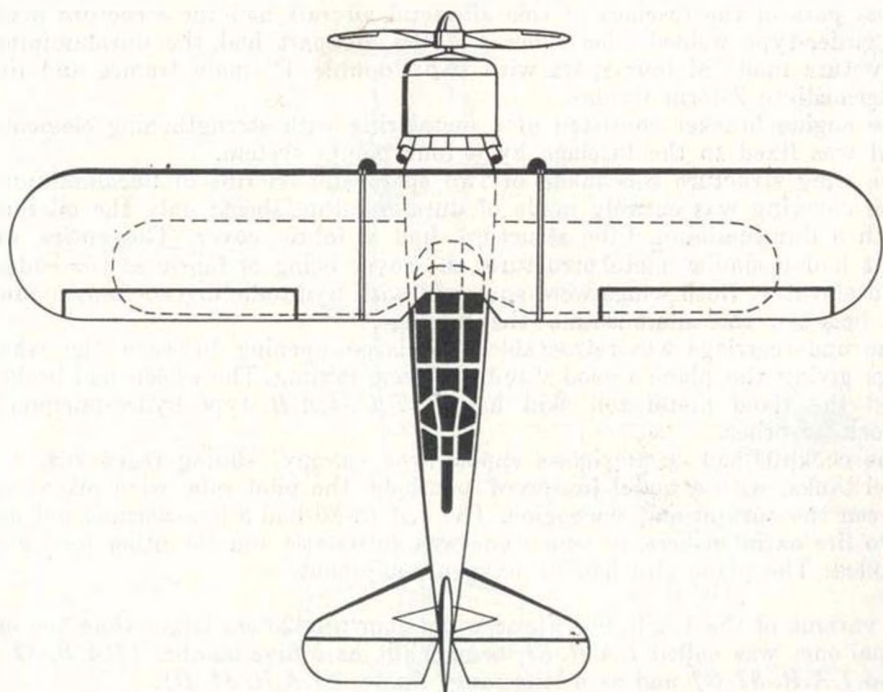
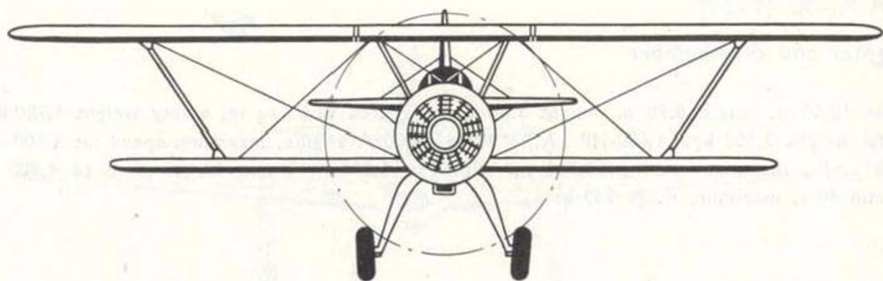



## I.A.R.-80 (1939)

Fighter and dive-bomber

Span 10.50 m, length 8.90 m, height 3.60 m, wing area 16.00 sq m, empty weight 1,780 kg, total weight 2,550 kg, 1,000-HP I.A.R. K 14-1000 A engine, maximum speed (at 4,500 m) 510 km/h, maximum ceiling 10,500 m, climb to 1,000 m 1 min 20 s, climb to 4,500 m 5 min 40 s, maximum range 940 km.

The *I.A.R.-80* was a low-wing cantilever monoplane single-seater. The foremost part of the fuselage of this all-metal aircraft had the structure made of girder-type welded steel tubes and the aft part had the duraluminium structure made of four spars with two "double T" main frames and five intermediate Z-form frames.

The engine bracket consisted of a metal ring with strengthening elements, and was fixed to the fuselage by a four points system.

The wing structure was made of two spars and 38 ribs of duraluminium. The covering was entirely made of duraluminium sheet; only the ailerons, with a duraluminium tube structure, had a fabric cover. The entire tail unit had a similar metal structure, the cover being of fabric at the rudder and elevator. Both wings were equipped with hydraulic driven flaps mounted between the ailerons and the fuselage.

The undercarriage was retractable, the large opening between the wheel legs giving the plane a good stability during taxiing. The wheels had brakes, and the fixed metal tail skid had a *T.U.-I.A.R.* type hydro-pneumatic shock absorber.

The cockpit had a plexiglass cupola-type canopy, sliding rearwards. The fuel tanks, with a metal fire-proof panel on the pilot side, were placed between the cockpit and the engine. The *I.A.R.-80* had a fire warning net and two fire extinguishers, of which one was automatic and the other pilot controlled. The plane also had an oxygen equipment.

A variant of the *I.A.R.-80*, whose wing span was 20 cm larger than the original one, was called *I.A.R.-81*, being built as a dive-bomber (*I.A.R.-81 A* and *I.A.R.-81 C*) and as a long-range fighter (*I.A.R.-81 B*).



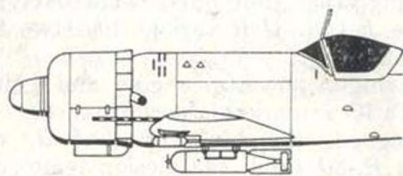
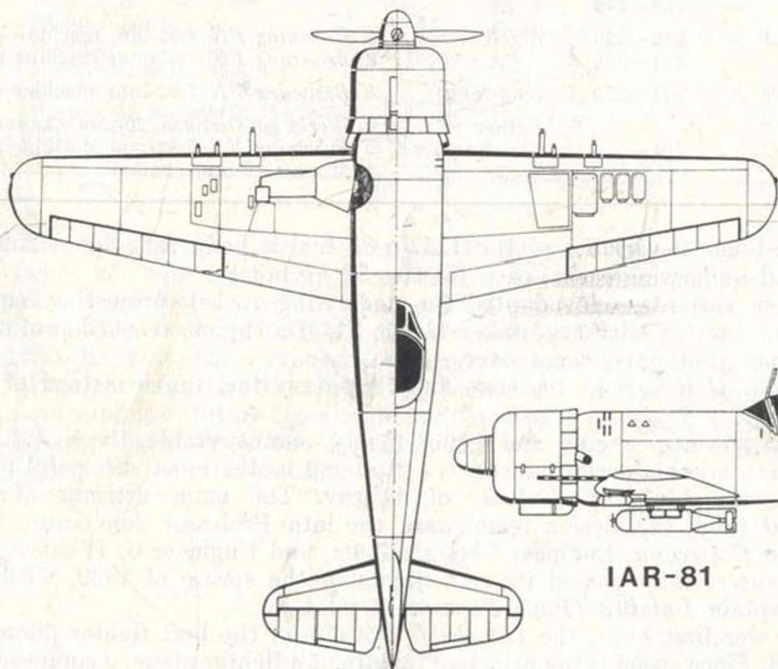
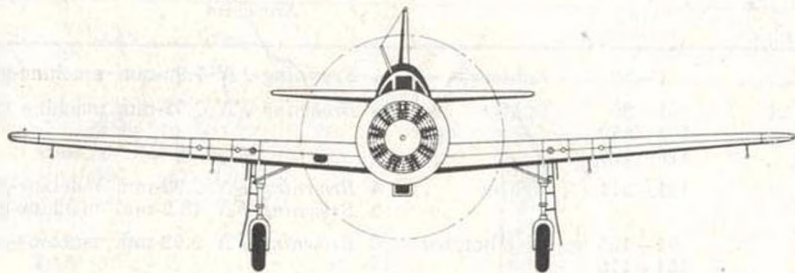
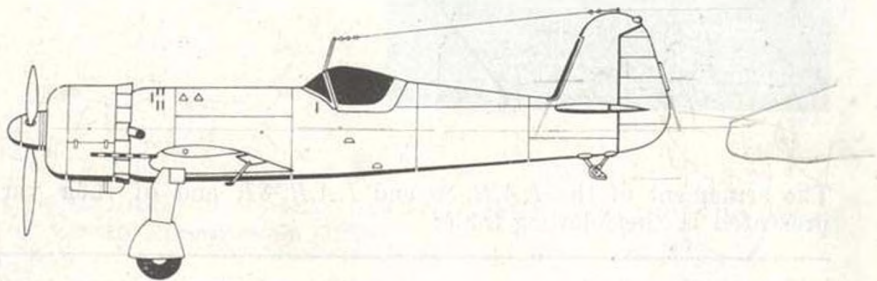

IAR-81



*I.A.R.-80*, front view.

The armament of the *I.A.R.-80* and *I.A.R.-81*, and of their variants, is presented in the following table:

Type of aircraft	Series		Armament
<i>I.A.R.-80</i>	1-50	fighter	4 <i>Browning FN</i> 7.92-mm machine-guns
<i>I.A.R.-80 A</i>	51-90	fighter	6 <i>Browning FN</i> 7.92-mm machine guns
	106-150		
	176-180		
<i>I.A.R.-80 B</i>	181-211	fighter	4 <i>Browning FN</i> 7.92-mm machine-guns 2 <i>Browning FN</i> 13.2-mm machine-guns
<i>I.A.R.-81</i>	91-105	dive-bomber	6 <i>Browning FN</i> 9.92-mm machine-guns
	151-175		
	231-240		
<i>I.A.R.-81 A</i>	212-230	dive-bomber	4 <i>Browning FN</i> 7.92-mm machine guns 2 <i>Browning FN</i> 13.2-mm machine guns
	291-300		
<i>I.A.R.-81 B</i>	241-290	long-range	4 <i>Browning FN</i> 7.92-mm machine-guns
		fighter	2 <i>Ikaria</i> or <i>Oerlikon</i> 20-mm cannon
<i>I.A.R.-81 C</i>	301-	dive-bomber	2 <i>Browning FN</i> 7.92-mm machine-guns 2 <i>Mauser</i> 20-mm cannon

The dive-bomber variants of the *I.A.R.-81* had a belly rack for a 250 kg bomb and underwing racks, each for two 50 kg bombs.

Two other variants, one adapted for underwing rocket projectiles equipment, and another with an Junkers Jumo 211 Da engine, reached prototype flying stage, but never went over.

The *I.A.R.-81 B* variant had two supplementary fuel tanks instead of the bombs.

Having a powerful engine and being highly manoeuvrable, the *I.A.R.-80*, with its remarkable performances, is considered as the most successful plane designed and built by *I.A.R.* of Braşov. The main artisans of the *I.A.R.-80* (and *81*) design team were the late Professor *Ion Grosu*, Professor *Ion Coşoreanu*, Engineer *Gheorghe Zotta* and Engineer *G. Wallner*. The aircraft successfully passed its test flights in the spring of 1939, with Air Force Captain *Dumitru (Puşi) Popescu* as pilot.

When it was first built, the *I.A.R.-80* was one of the best fighter planes in the world. Since speed is the principal feature of a fighter plane, a comparative

*I.A.R.-80 DC* (dual control).

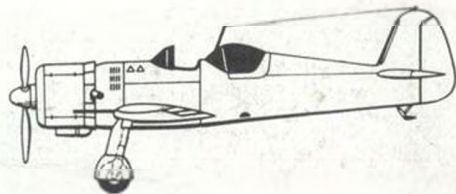

table is given, listing the speeds of several fighter aircraft used by the air forces of various countries in 1939:

Type of aircraft	Country	Maximum speed km/h
Fiat C.R.-32	Italy	390
Dewoitine-510	France	404
Gloster Gladiator	Great Britain	407
Breda-65	Italy	410
P.Z.L.-24	Poland	430
I-153	USSR	440
Fokker D-21	Holland	460
I-16	USSR	470
Fiat G.50	Italy	480
Heinkel He-112	Germany	480
Seversky P.35	USA	485
Morane-Saulnier M.S.-406	France	490
<i>I.A.R.-80</i>	<i>Romania</i>	<i>510</i>
Messerschmitt B.F.W. Me-109	Germany	520
Curtiss P-37	USA	550

The above table shows that out of the 15 types of fighter aircraft used by air forces of countries having an advanced aeronautical industry, only two machines were faster than the Romanian *I.A.R.-80*, which was used by the Romanian Air Force up to the end of the second world war.

In 1950 the *Atelierele de reparatii material volant (A.R.M.V.)* of Pipera built a two-seater variant of the *I.A.R.-80*, called *I.A.R.-80 DC* (dual control), for the training of future fighter pilots. This was a successful variant, despite the changes made in it. The *I.A.R.-80 DC* was used by the military flying schools up to the end of 1952.





### J.R.S.-79 B SAVOIA MARCHETTI (1940)

Medium-to-heavy bomber and reconnaissance aircraft\*

Span 21.20 m, length 16.82 m, height 5.55 m, wing area 60.60 sq m, empty weight 7,000 kg, total weight 12,000 kg, two 1,200-HP Junkers Jumo 211 D engines, maximum speed 425 km/h, minimum speed 160 km/h, maximum ceiling 7,700 m, maximum range 1,900 km, endurance 5 hours, take-off run 400 m, landing run 350 m.

The *J.R.S.-79 B* twin-engine aircraft, mass-produced for the Romanian Air Force, carried a crew of four. The frame of the fuselage and the tail unit were made of welded chrome-molibdenum tubes and the cover of fabric. The wings were covered with plywood, and had extension and *Handley Page* slotted flaps on the leading edge. The undercarriage was retracted into the engine nacelles. The three-blade variable pitch metal propellers were electrically controlled.

A series of *J.R.S.-79 B* planes had *I.A.R. K 14* engines.

The *J.R.S.-79 B* carried 1,400 kg of bombs in the fuselage, and its defensive armament comprised three 13-mm machine-guns.

\* Built by the *I.A.R.* factory of Braşov after a modified licence of the Italian *Savoia Marchetti-79 B*.

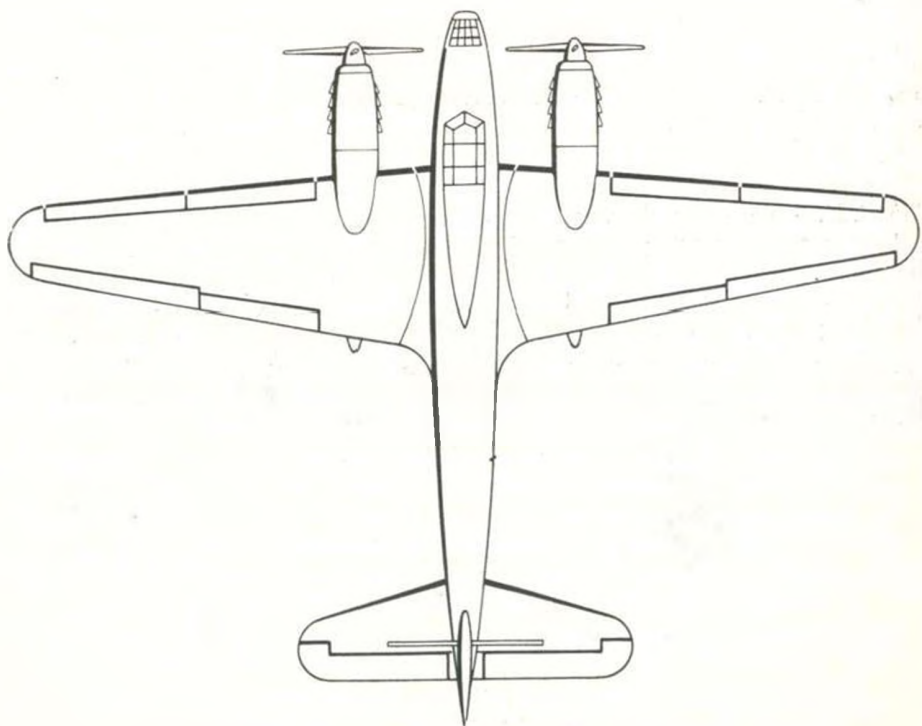
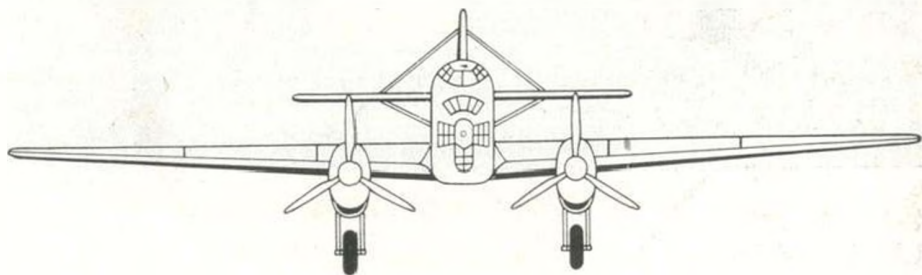
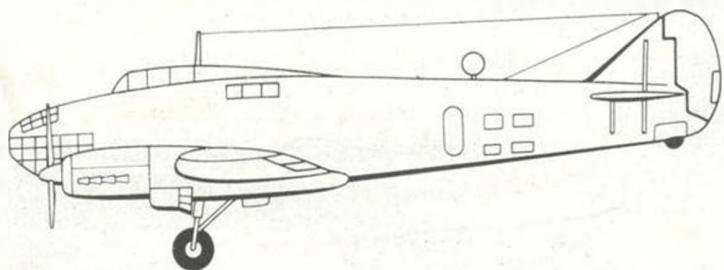

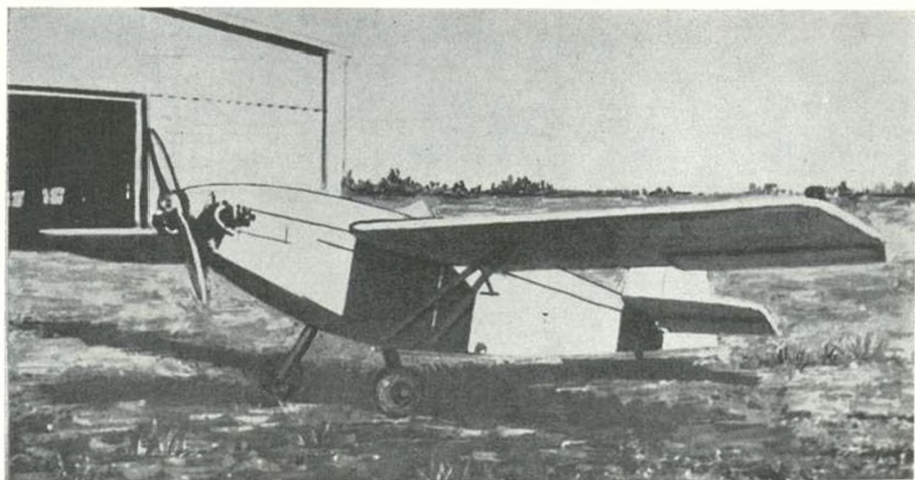

### R.M.-9 (1942)

Sports and touring aircraft

Span 7.50 m, length 5.50 m, wing area 9.00 sq m, empty weight 255 kg, payload 125 kg, total weight 350 kg, 32-HP Praga engine, maximum speed 138 km/h, minimum speed 55 km/h, maximum range 1,000 km, endurance 8 hours.

The *R.M.-9* high-wing single-seater was built in the workshops of the *I.A.R.* factory of Braşov after the design of Engineer *Radu Manicatide*. The half-shell type fuselage had a timber frame covered by fabric. The wings and the undercarriage were attached to the central frame section of the fuselage. The luggage room was in the forward section of the fuselage. The monospar type wings were covered by fabric (except for the leading edge which had a plywood cover); they had mechanically (hand) controlled flaps. The tail unit had a wood frame and fabric cover.



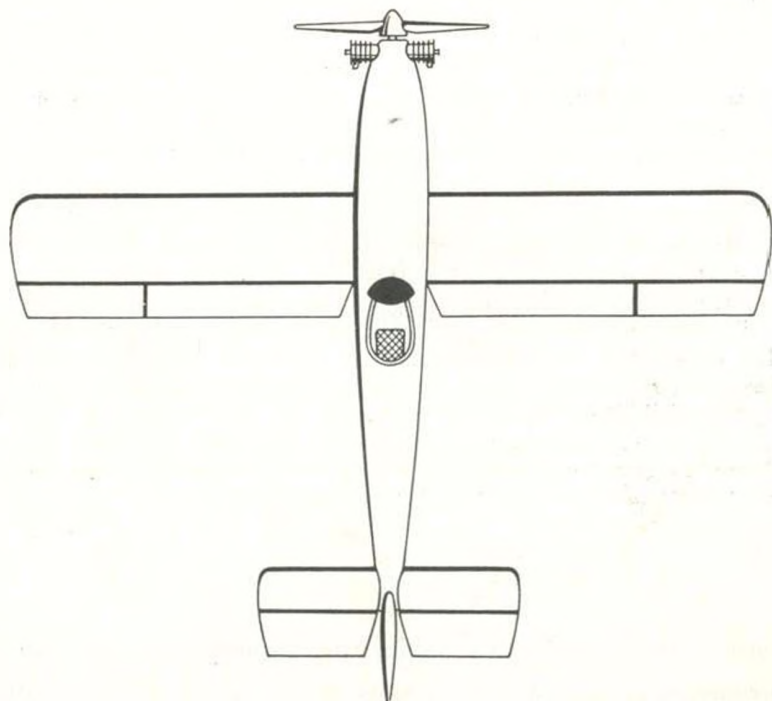
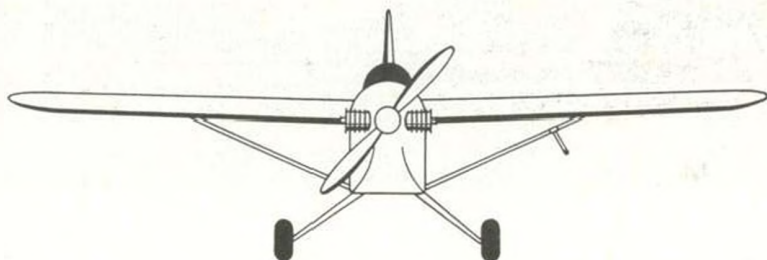
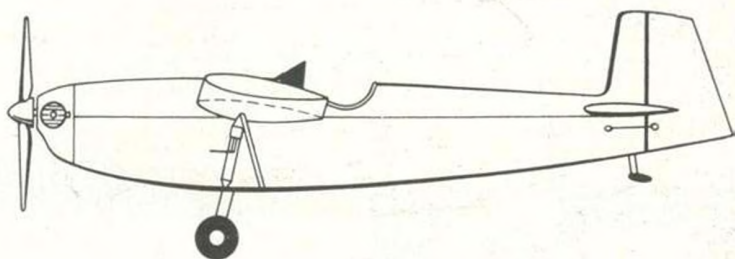



## FIESELER Fi-156 STORCH (1942)

Light multi-purpose aircraft\*

Span 14.25 m, length 9.75 m, height 3.76 m, wing area 26.00 sq m, empty weight 930 kg, total weight 1,326 kg, 240-HP Argus As 10 C engine, maximum speed 175 km/h, cruising speed 128 km/h, minimum speed 52 km/h, ceiling 5,090 m, climb to 1,000 m 4 min.

The *Fieseler Storch* was specially designed for take-offs and landings on very short strips. Equipped with a fixed slot along the entire leading edge, and with the entire trailing-edge hinged, the outer positions acting as slotted ailerons and the inner portions as slotted camber-changing flaps. It needed only 60 m for take-offs and 28 m for landings. \*\*

The *Fieseler Storch* had a metal frame and fabric cover. The cockpit had a very good visibility. The plane was used as an observation and liaison machine, and as an ambulance aircraft (up to 1964). In addition to the pilot, it could carry two persons or a stretcher case and an attendant. The *Fieseler Storch* was also used for glider towing.

\* Built under licence by the *I.C.A.R.* factory after the designs of the German *Fieseler Storch*.

\*\* If necessary, an experienced pilot could take off and land on even shorter strips.

Fliegerschule  
FIESELER Fi-156 STORCH

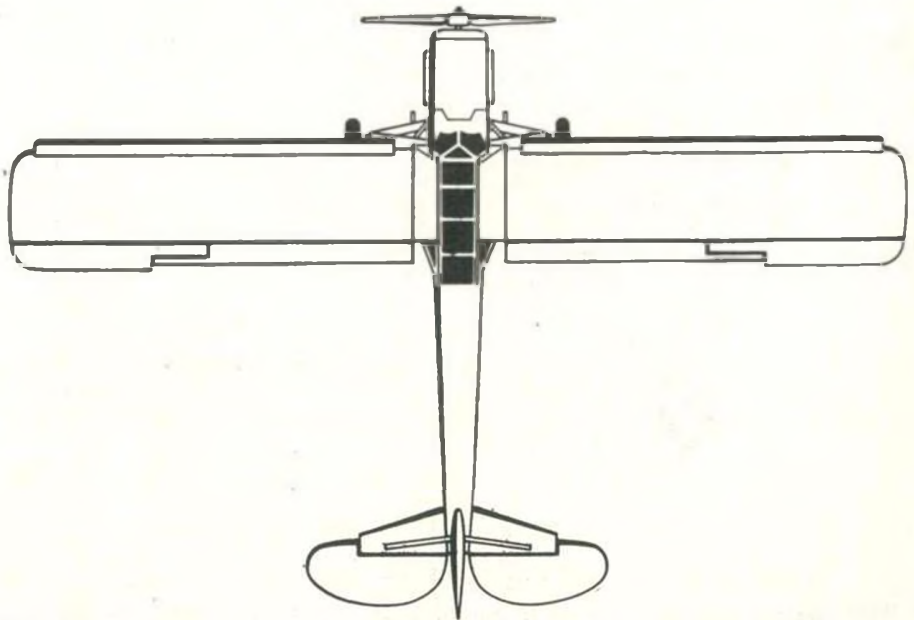
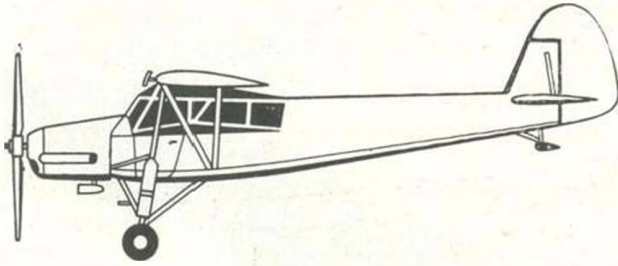





## MESSERSCHMITT Me-109 G (1944)

Fighter aircraft\*

Span 9.92 m, length 8.85 m, height 3.20 m, wing area 16.20 sq m, total weight 3,400 kg, 1,475-HP Daimler-Benz 605 A-1 engine, maximum speed at 5,500 m 615 km/h, maximum ceiling 11,800 m, climb to 5,800 m 6 min, maximum range 800 km (with supplementary tanks).

Rated as one of the best fighter aircraft of the second world war, the *Me-109 G* was an all-metal aircraft, with an airtight type cockpit and oxygen equipment for high altitude flying. The undercarriage was retractable. The armament of the *Me-109 G* included a 20-mm cannon firing through the propeller hub and two 13.2-mm machine-guns under the engine hood.

\* Built under licence by I.A.R. of Braşov on the design of the original German type

MESSERSCHMITT Me-109 G

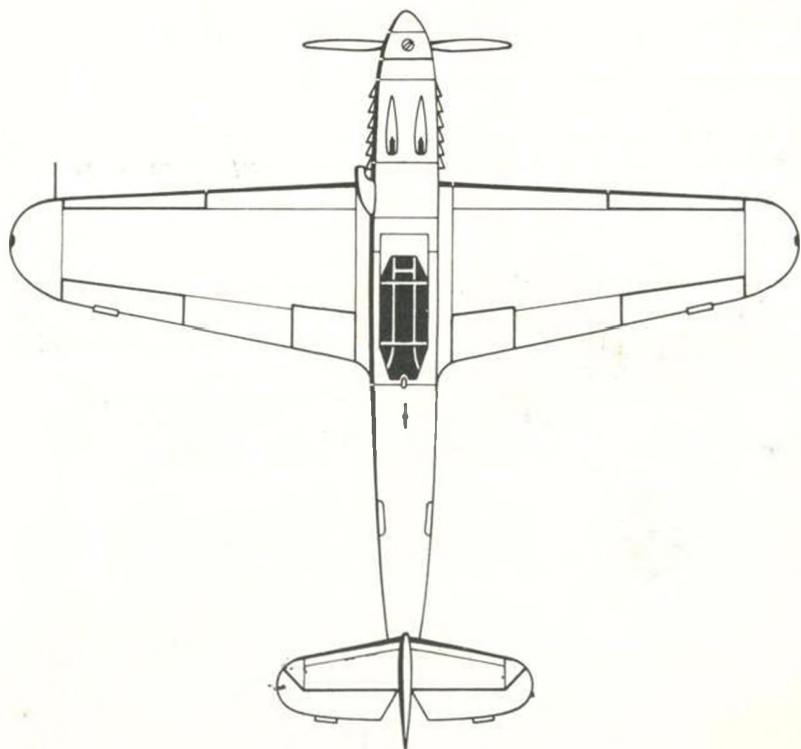
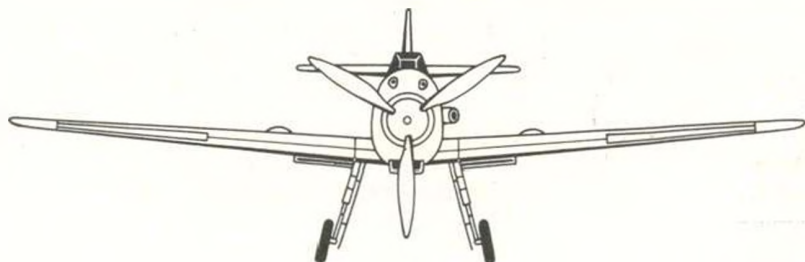
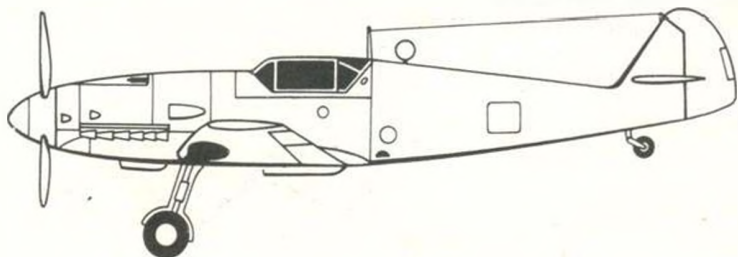



## R.M.-11 (1944)

Two-seater touring aircraft

Span 7.50 m, length 5.80 m, wing area 15.00 sq m, empty weight 303 kg, payload 227 kg, total weight 530 kg, 60-HP Train engine, maximum speed 175 km/h, minimum speed 70 km/h, maximum ceiling 4,000 m, maximum range 800 km.

The *R.M.-11* two-seater, designed by Engineer *Radu Manicatide*, had the horizontal tail piece in forward position, and the engine at the rear, with a propulsive propeller. The rectangular wings had directional stability vertical surfaces and the rudders at their tips.

The fuselage, whose frame was made of steel tubes, was covered by fabric, and the wings with plywood. The undercarriage, with a mechanically controlled castorable forward wheel, had mechanical brakes.



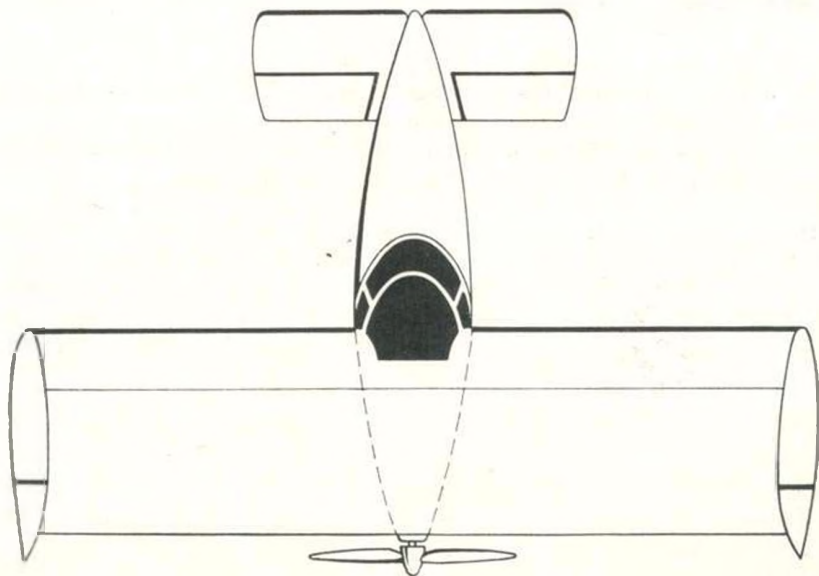
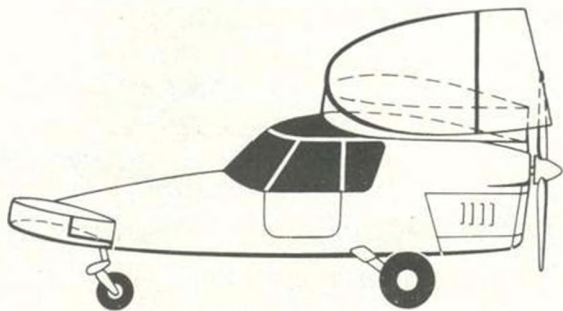



### I.A.R.-811 (1949)

Sports and training aircraft

Span 10.40 m, length 8.25 m, height 2.20 m, wing area 17.30 sq m, empty weight 420 kg, total weight 650 kg, 60-HP Train engine, maximum speed 150 km/h, minimum speed 65 km/h, maximum ceiling 3,700 m, maximum range 450 km, take-off run 180 m, landing run 140 m.

The *I.A.R.-811* was the first new plane to be built in Romania after August 23, 1944.

It was designed and built at the *Tractorul* works of Braşov by a team headed by Engineer *Radu Manicatide*. For its activity the team was awarded the State Prize.

The frame of the plane was made entirely of timber, with the cover of plywood. The monoplane wings had trailing-edge flaps. The undercarriage was of the independent fixed type. The *I.A.R.-811* had two dual-control seats placed next to each other, a frequently adopted solution for school aircraft. The plexiglass covered cockpit had two side doors.

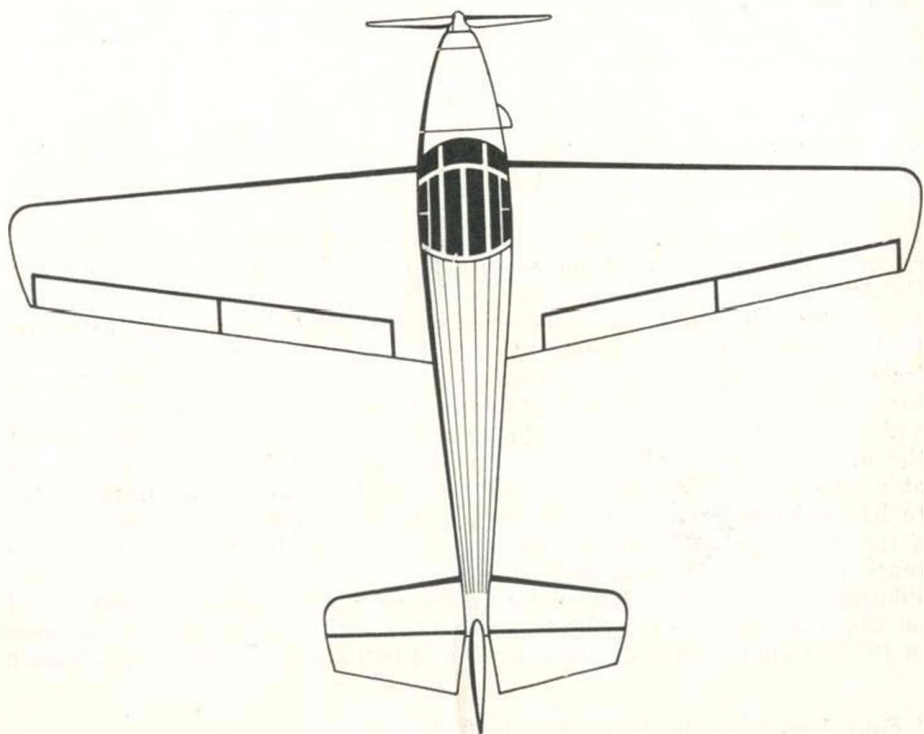
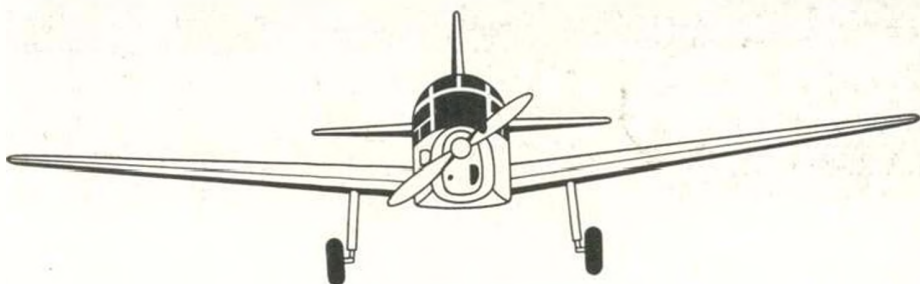
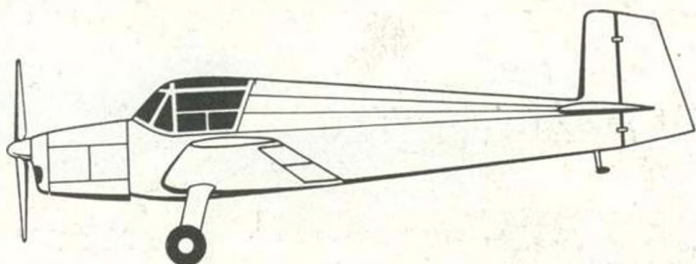





### I.A.R.-813 (1950)

Primary and basic training, and aerobatics aircraft

Span 10.00 m, length 8.35 m, height 2.25 m, wing area 15.00 sq m, empty weight 498 kg total weight 750 kg, 105 HP Walter Minor engine, maximum speed 192 km/h, minimum speed 75 km/h, maximum ceiling 5,800 m, maximum range 700 km, take-off run 180 m, landing, run 150 m.

The *I.A.R.-813* was conceived and built by a team of the *Uzinele de reparații material volant (U.R.M.V.-3)* of Brașov after the design of Engineer *Radu Manicatile*.

This aircraft established several national and international height and speed records in the C-1b class (planes with a take-off weight of 500-1,000 kg). On April 12, 1957, taking off from the airfield of Strejnic (Ploiești), Miss *Elena Barac* set up a national height record of 6,461 m on an *I.A.R.-813*. In 1958, flying in a formation of three *I.A.R.-813*, pilots *Constantin Manolache*, *Simion Oțoiu* and *Constantin Onciu* established three international speed records on an official route homologated by the *International Aeronautical Federation (F.A.I.)*.\* On July 4, 1958, the three planes covered the distance from Bucharest to Kiev in four hours, 11 min and 43 sec, at a speed of 177.941 km/h. On July 25 the three pilots flew from Moscow to Kiev with a speed of 160.796 km/h, and the following day they reached a speed of 172.354 km/h, covering in formation the Kiev-Bucharest distance in 4 hours, 19 min and 52 sec.

Piloting an *I.A.R.-813*, *Bănică Enciulescu* set up two national speed records on the same day: on a closed circuit of 500 km he flew at a speed of 197.954 km/h, and on a closed circuit of 1,000 km he reached 197.335 km/h.

\* *F.A.I. Bulletins* no. 104/1965 and no. 106/1967.

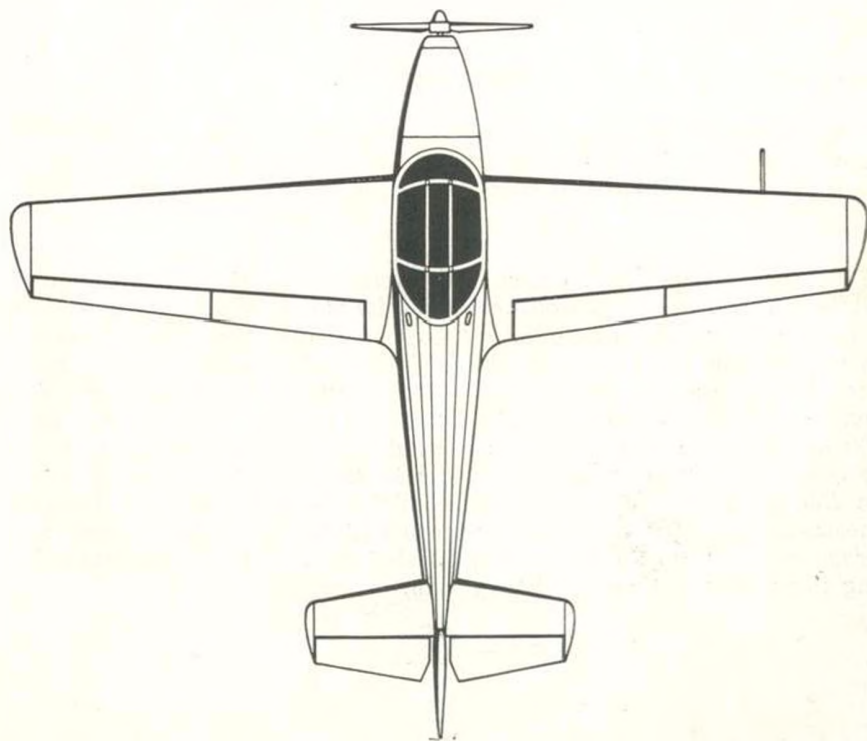
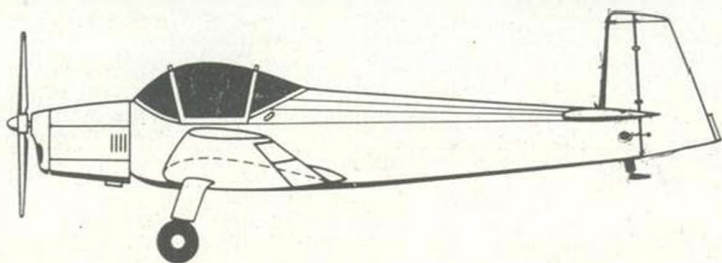



### I.A.R.-814 (1953)

Training, ambulance and light transport aircraft

Span 14.00 m, length 11.05 m, height 2.92 m, wing area 28.00 sq m, empty weight 1,400 kg, total weight 2,030 kg., two 160-HP Walter Minor 6 III engines, maximum speed 272 km/h, minimum speed 85 km/h, maximum ceiling 5,600 m, maximum range 950 km.

The *I.A.R.-814*, the first twin-engined aircraft of all-Romanian design, was built by the *Uzinele de reparatii material volant (U.R.M.V.-3)* of Braşov after the plans of Engineer *Radu Manicatide*. A modern plane of mixed construction (timber and metal), having blind-flying and radio equipment, it confirmed its qualities by establishing a long distance *world record* in closed circuit for planes of the C-1d class (take-off weight between 1,750 and 3,000 kg), recognized by the *International Aeronautical Federation (F.A.I.)*. The world record was set up on October 14 and 15, 1961 by test pilot *Octavian Băcanu*, Master of Sports, and copilot *Vladimir Viscun* on the circuit Băneasa-Alexeni-Strejnic-Băneasa over a distance of 4,462.870 km at an average speed of 216 km/h. The flight lasted 20 h and 41 min, many hours being flown at night and in heavy rain.



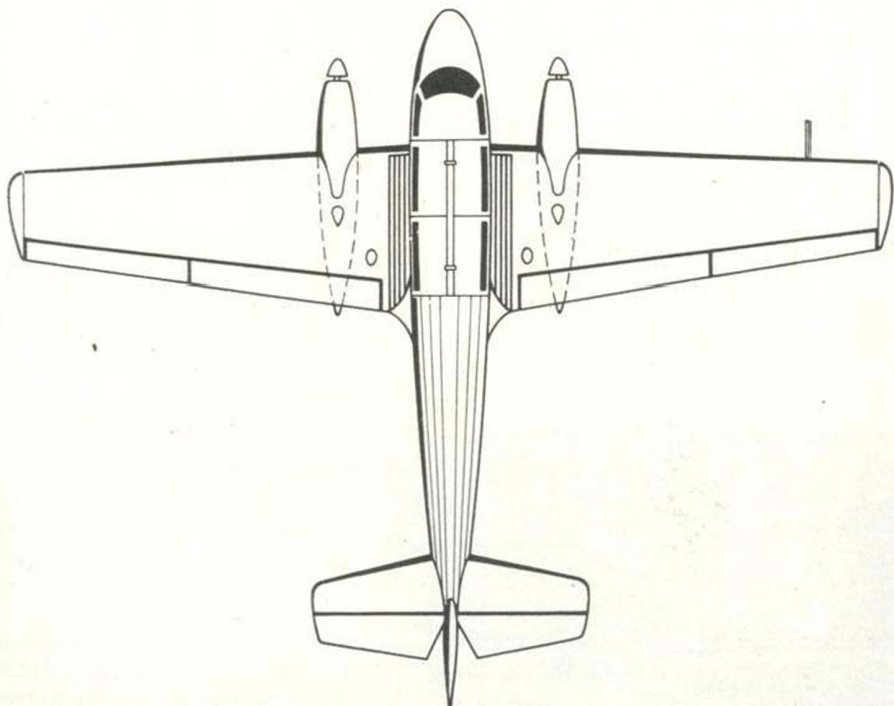
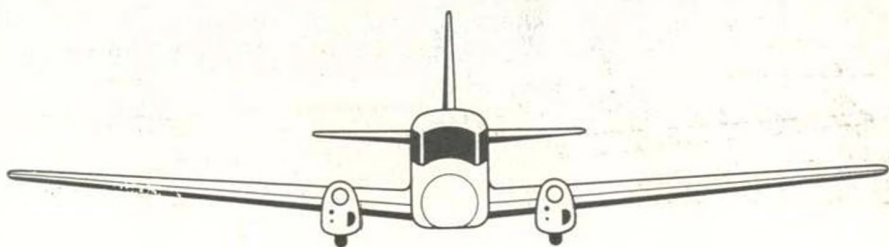
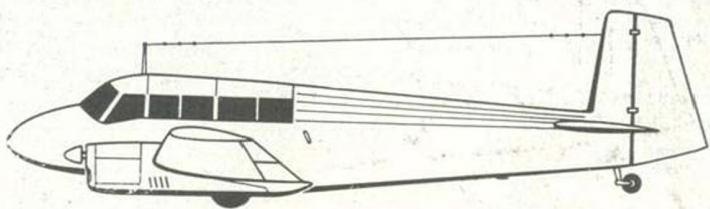

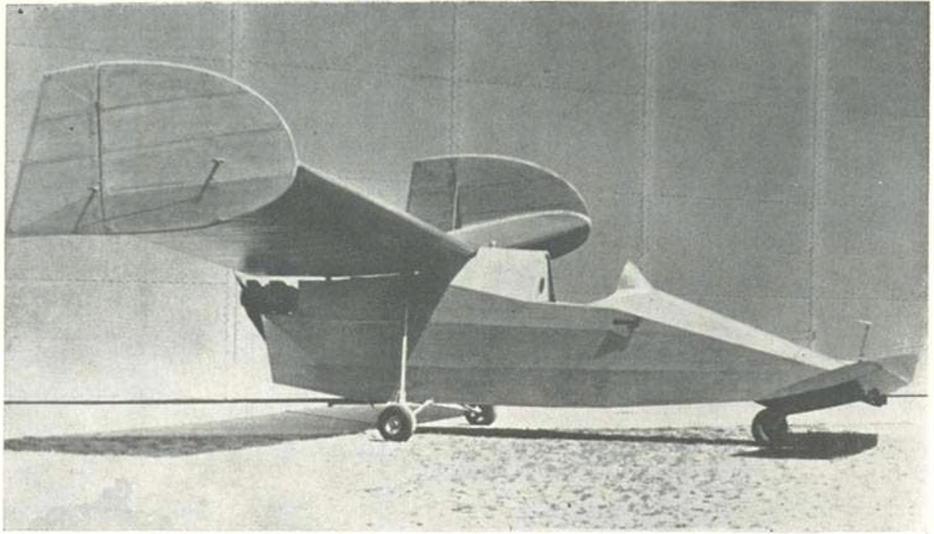

## R.M.-12 (1953)

Experimental aircraft

Span 6.00 m, length 4.70 m, height 2.60 m, wing area 10.00 sq m, empty weight 132 kg, total weight 230 kg., 2-cylinder 20-HP engine, maximum speed 125 km/h, minimum speed 65 km/h, maximum ceiling 2,500 m, maximum range 220 km, take-off run 90 m, landing run 70 m.

The experimental single-seater *R.M.-12* was designed and built by Engineer *Radu Manicatide* at the *Uzinele de reparații material volant (U.R.M.V.-3)* of Brașov. It was a high wing monoplane with a forward positioned stabilizer and elevator, and a propulsive (pusher) propeller. The vertical fixed and directional surfaces and rudders were placed at the wing tips.

Since the wings had no ailerons, the plane was piloted by the elevation controls and by the movement of the rudders.

The fixed tricycle undercarriage had a frontal castorable wheel. A two-cylinder 3,000 rpm engine was designed and built for this plane at the *U.R.M.V.-3*.

The original *R.M.-12* machine is on show at the Central Military Museum of Bucharest.

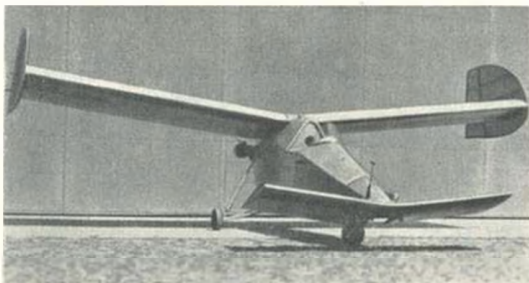

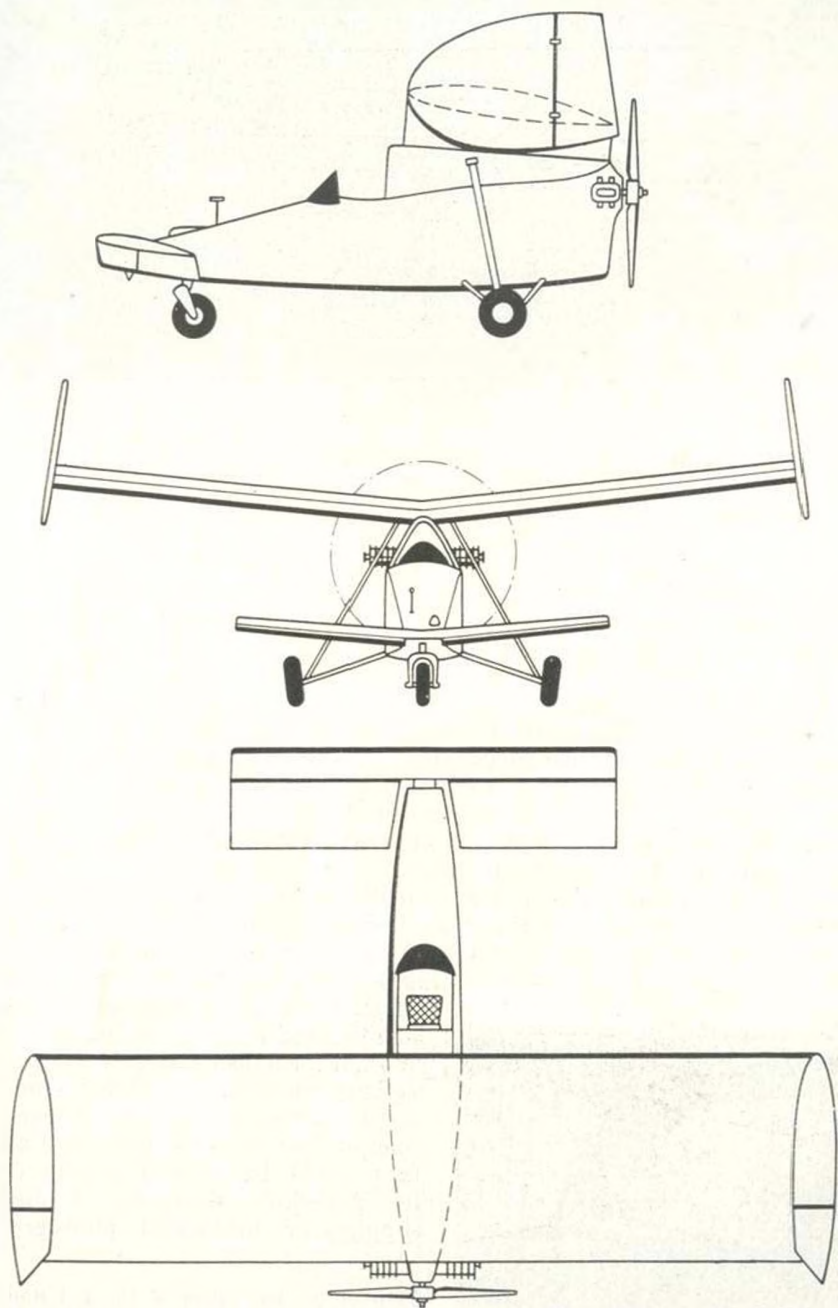





### I.A.R.-817 (1955)

Utility aircraft

Span 12.60 m, length 9.80 m, height 3.40 m, wing area 25.40 sq m, empty weight 800 kg, Max. T.O weight 1,150 kg, 160-HP Walter Minor 6 III engine, maximum speed 175 km/h, minimum speed 70 km/h, service ceiling 3,000 m, climb to 1,000 m 7 min. 30 s, maximum range 560-930 km, take-off run 150-180 m, landing run 60 m.

This was the first utility aircraft to be built in Romania. It was conceived at the Institute for Applied Mechanics of the Romanian Academy and designed and manufactured by a team of the *Uzinele de reparatii material volant (U.R.M.V.-3)* of Braşov, headed by Engineer *Radu Manicatile*. The tricycle undercarriage, with a front castoring wheel, had rubber shock-absorbers and mechanical wheel brakes.

The *I.A.R.-817* could be used for agricultural operations, parachute jump training, postal service, for the parachute dropping of medical supplies and as ambulance aircraft. The latter variant was built in 1957, known as the *I.A.R.-817 S*, and accommodating three persons: the pilot, a sick person on stretcher and a medical attendant. The thinned form of the fuselage rear allowed for a back door, through which various goods or a stretcher could be rapidly passed. The completely enclosed cockpit had two side doors, and a trap that could be opened during flying for parachute dropping of medical supplies or for aerial photography.



View of the back door of the *I.A.R.-817 S*.

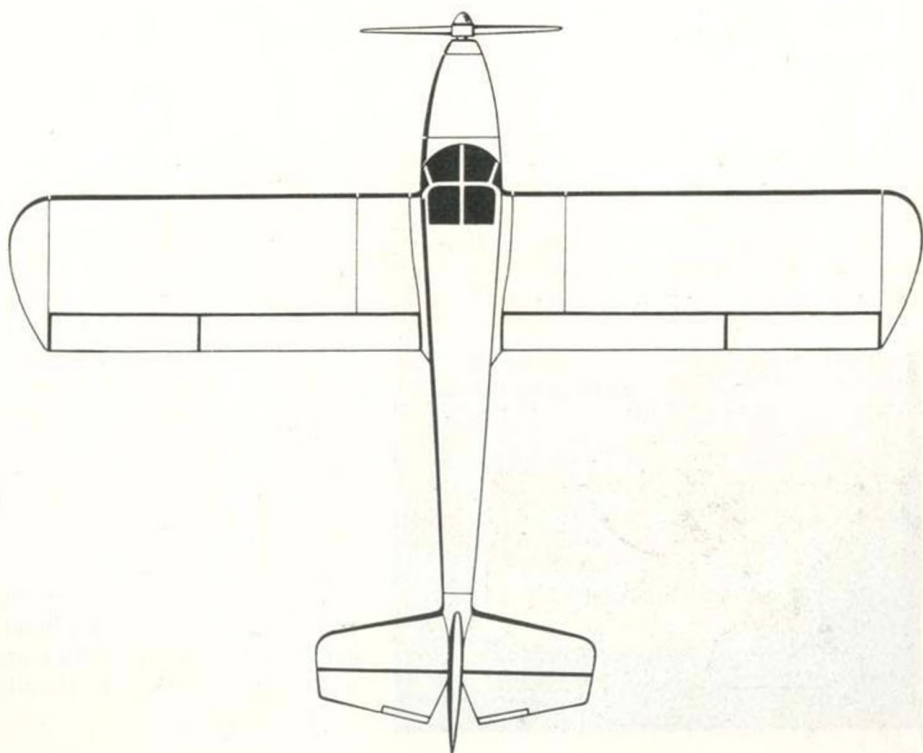



## M.R.-2 (1956)

Light transport aircraft

Span 14.00 m, length 10.90 m, height 2.76 m, wing area 28.00 sq m, empty weight 1,415 kg, total weight 2,080 kg, two 160-HP Walter Minor 6 III engines, maximum speed 275 km/h, minimum speed 85 km/h, maximum ceiling 4,900 m, maximum range 1,100 km, take-off run 400 m, landing run 280 m.

The *M.R.-2* was designed by Engineer *Radu Manicatide* and built by the *Uzinele de reparații material volant (U.R.M.V.-3)* of Brașov, being a variant of the *I.A.R.-814*.

In addition to the pilot, it carries five passengers. The ambulance variant takes two stretcher cases and an attendant.

The wings, with a single timber spar, are covered by plywood. The central wing section is made of metal. The fuselage, having a welded steel tube frame, is covered partially in wood and partially in fabric. The horizontal tail pieces are made of timber and the vertical ones have a metal frame and fabric covering. The electrically controlled retractable undercarriage has rubber shock-absorbers and mechanical brakes. The airscrews are of metal, with electrically adjusted pitch.





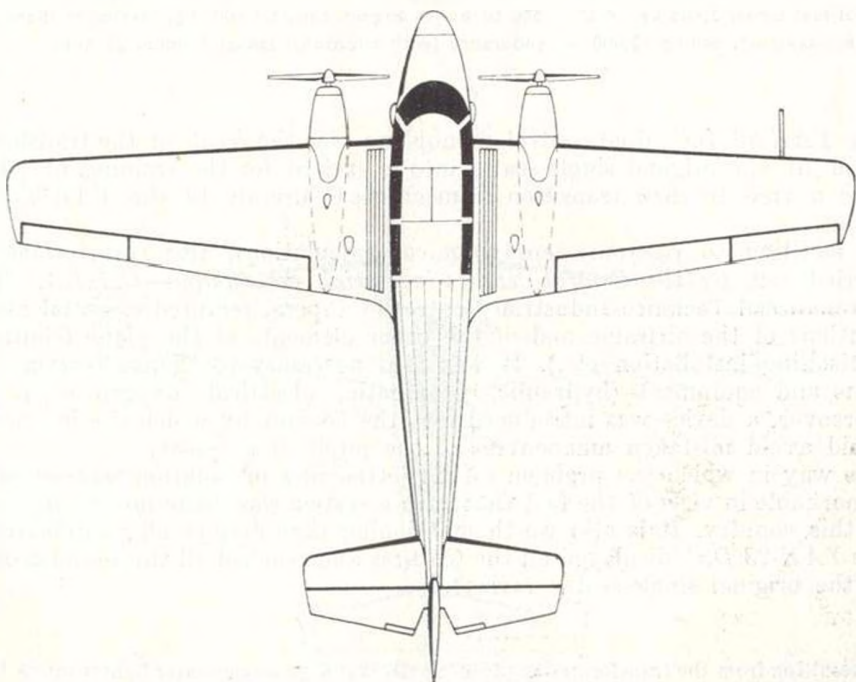
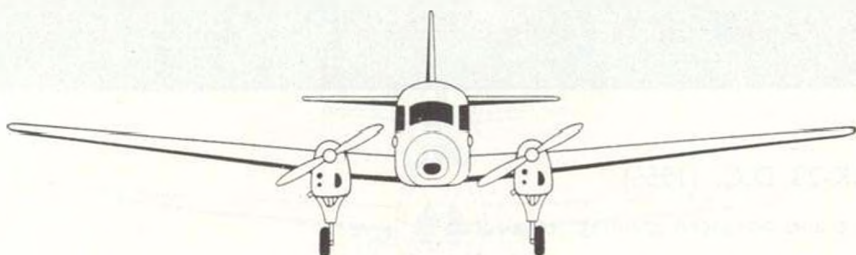
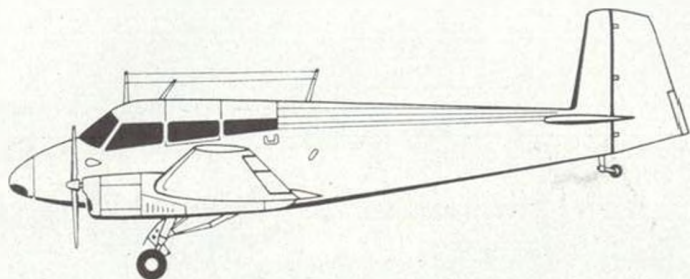

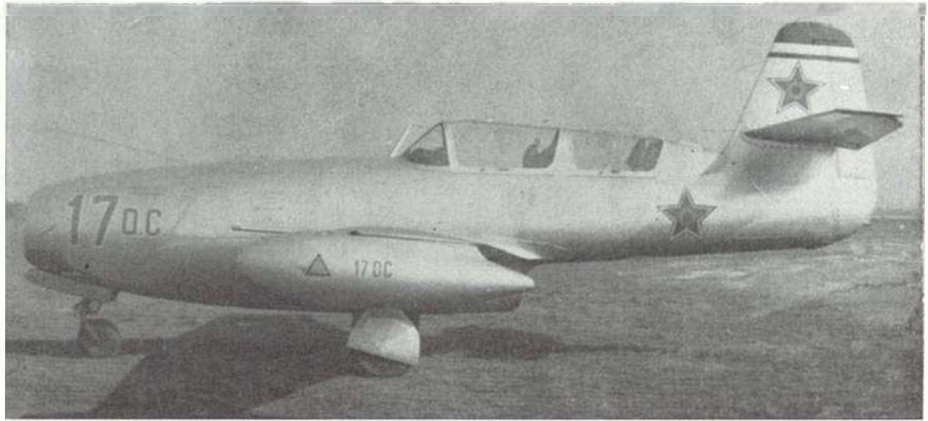

### YAK-23 D.C. (1956)

Basic and advanced training jet aircraft \*

Span 8.10 m, length 7.01 m, height 3.30 m, wing area 13.70 sq m, total weight (with additional fuel tanks) 3,405 kg. R.D. —500 turbo-jet engine, thrust 1,600 kg, maximum speed 890 km/h, maximum ceiling 12,000 m, endurance (with additional tanks) 1 hour, 25 min.

The *YAK-23 D.C.* dual-control monoplaner was the result of the transformation of the original single-seater into a variant for the training of pilots with a view to their transition from classical aircraft to the *YAK-23* jet plane.

In addition to rigorous aerodynamical calculations, this transformation, carried out by the *Centrul tehnico-industrial aeronautic — C.T.I.A.* (The Aeronautical Technico-Industrial Centre) of Pipera, required essential modifications of the airframe and of the other elements of the plane (controls, jettisoning installation etc.). It was also necessary to change certain systems and equipment (hydraulic, pneumatic, electrical, oxygen etc.).

Moreover, a device was introduced into the cockpit by which the instructor could avoid mistaken manoeuvres of the pupil, if necessary.

The way in which the problem of the jettisoning installation was solved is remarkable in view of the fact that such a system was made for the first time in this country. It is also worth mentioning that despite all modifications, the *YAK-23 D.C.* displayed all the features and reached all the performances of the original single-seater variant.

\* Resulting from the transformation of the Soviet *YAK-23* single-seater fighter into a two-seater variant.

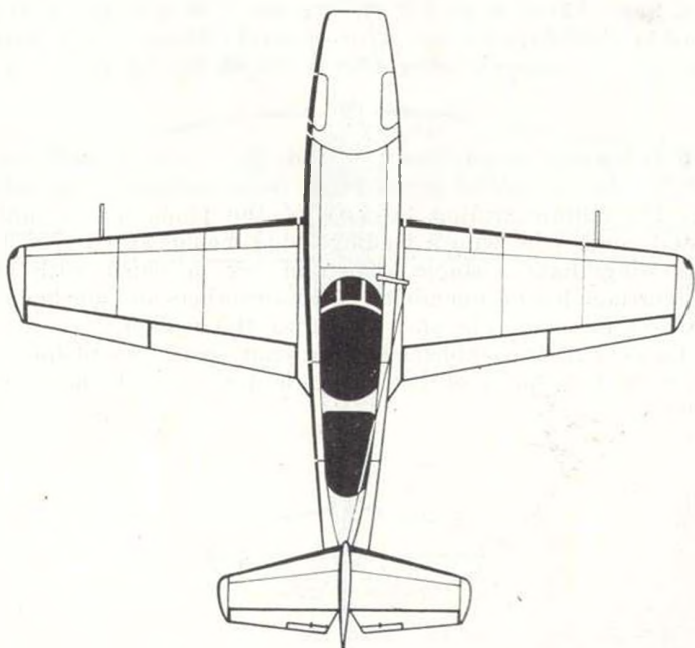
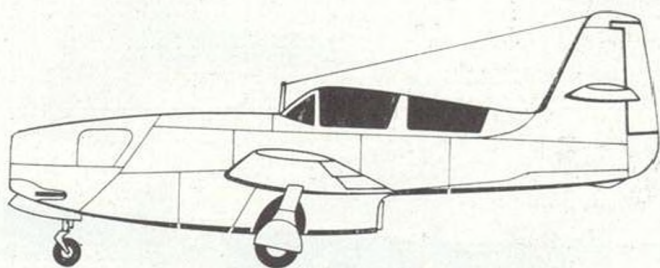



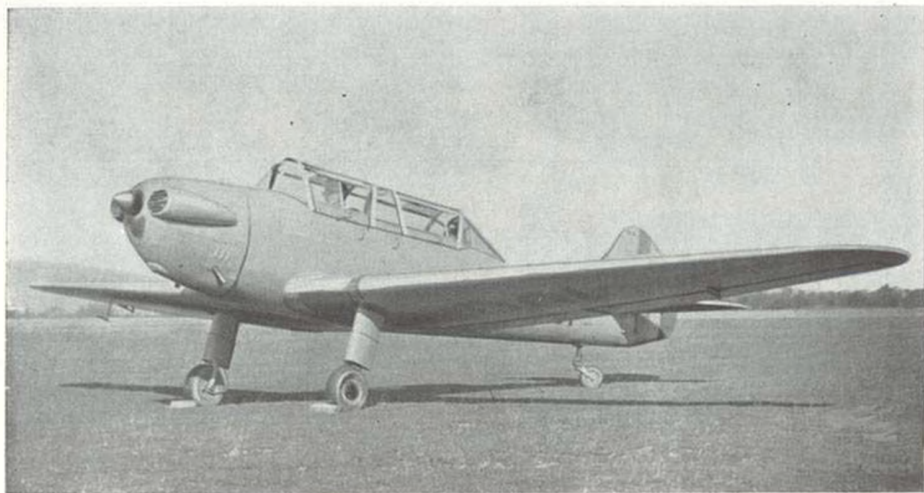

## R.G.-6 (1957)

Training aircraft

Span 10.50 m, length 7.50 m, height 2.62 m, wing area 14.50 sq m, empty weight 400 kg, total weight 650 kg, 75-HP Praga D engine, maximum speed 190 km/h, cruising speed 170 km/h, landing speed 65 km/h, maximum ceiling 4,800 m, take-off run 120 m, landing run 90 m.

The *R.G.-6* two-seater monoplane was made by a team headed by *Vladimir Novički* at the *Întreprinderea forestieră de industrializare a lemnului (IFIL)* of Reghin. The elliptic section fuselage of the plane has a timber frame and plywood cover (the wing's leading edge being also covered by plywood). The wings have a single spar and are provided with flaps. The fixed undercarriage has oil-pneumatic shock-absorbers and mechanical brakes. The tail wheel is castorable and linked to the rudder.

In 1957, *Vasile Petrila* established a national speed record for C-1a planes on a *R.G.-6*, with a speed of 183.28 km/h over a base measuring 3 km.

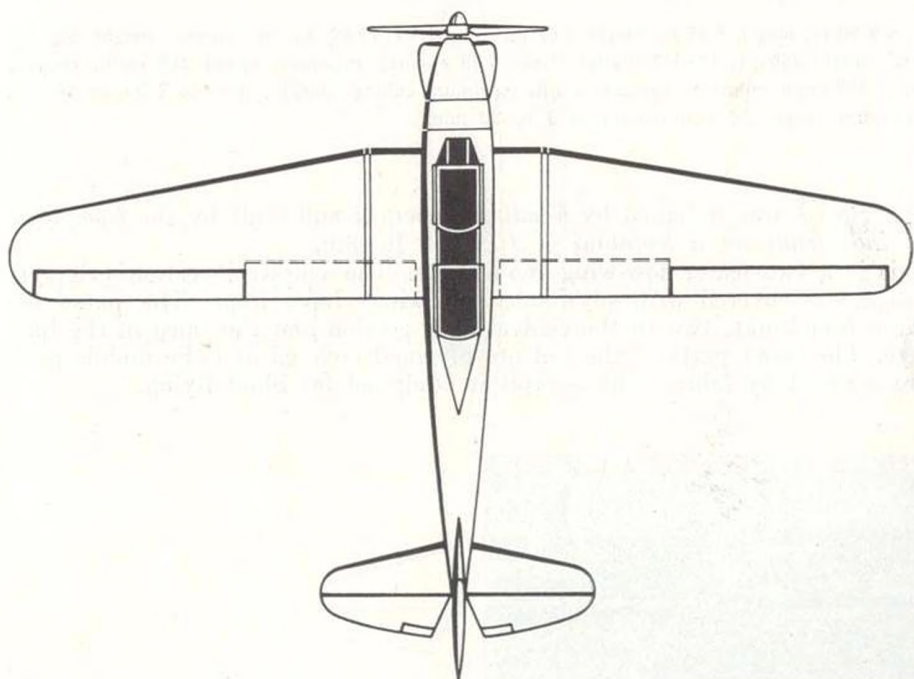
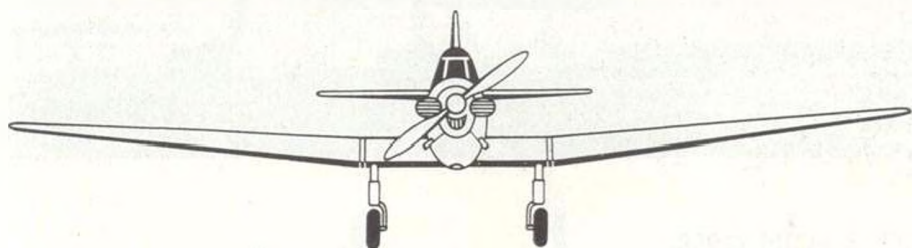
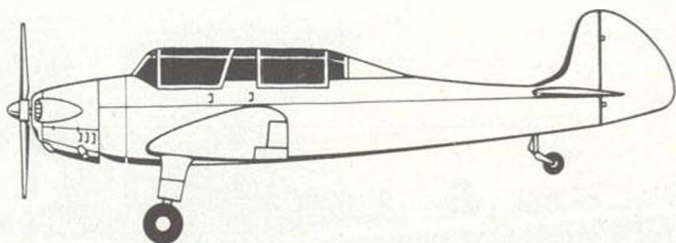



### R.G.-7 ŞOIM (1958)

Training and touring aircraft

Span 9.90 m, length 7.85 m, height 2.67 m, wing area 13.80 sq m, empty weight 520 kg, total weight 750 kg, 105-HP Walter Minor 4 III engine, maximum speed 215 km/h, cruising speed 195 km/h, minimum speed 65 km/h, maximum ceiling 5,000 m, climb to 3,000 m 14 min, maximum range 600 km, endurance 3 h, 30 min.

The *R.G.-7* was designed by *Vladimir Novički* and built by the *Complexul de industrializare a lemnului (C.I.L.)* of Reghin.

This is a two-seater low-wing monoplane. The elliptical section cell type fuselage is covered with plywood. The wings have flaps. The plane has three fuel tanks, two in the central wing section and the third in the fuselage. The fixed parts of the tail are plywood covered and the mobile parts are covered by fabric. The cockpit is equipped for blind flying.





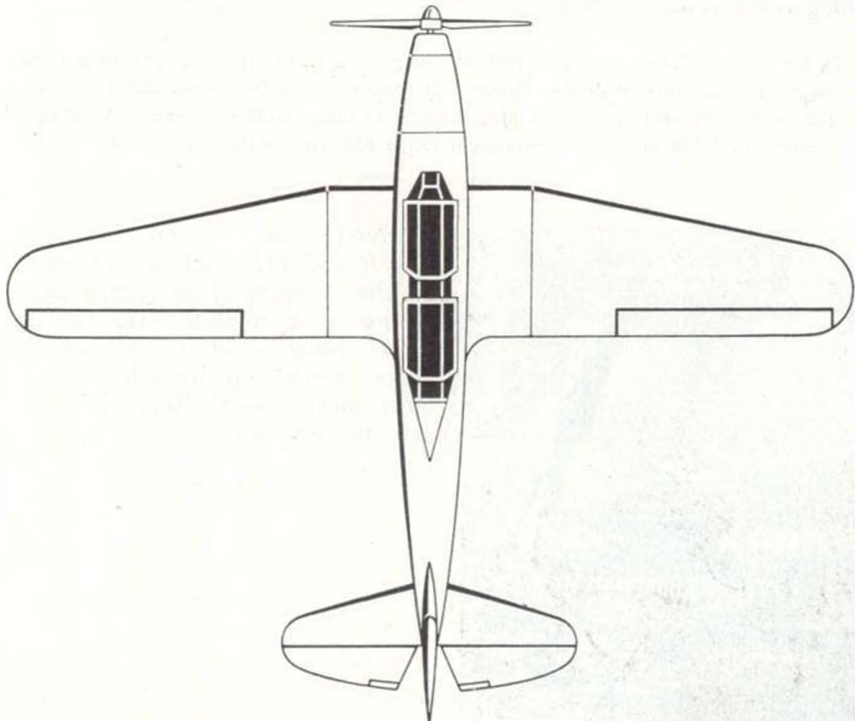
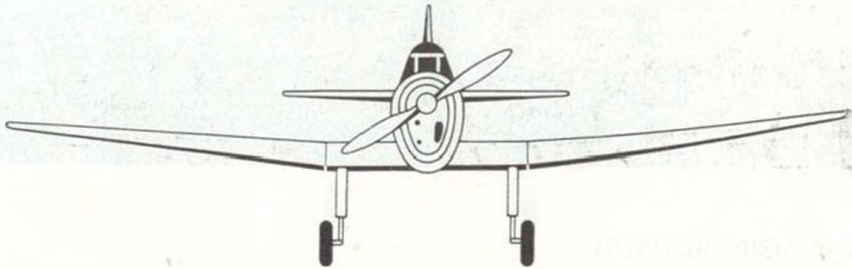
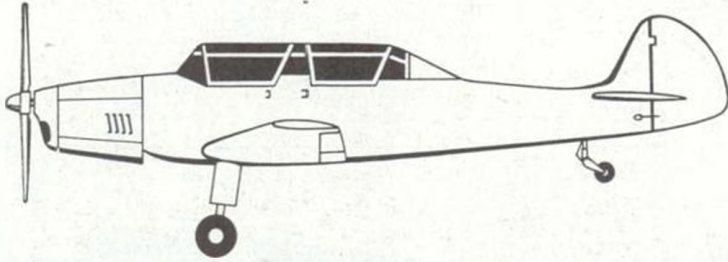

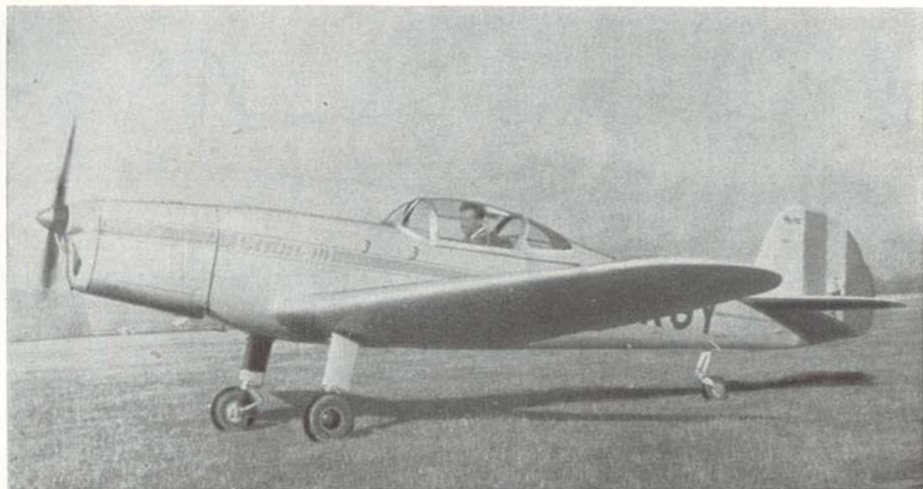

### R.G.-7 ȘOIM III (1959)

Training and aerobatics aircraft

Span 9.50 m, length 7.85 m, height 2.67 m, wing area 12.90 sq m, empty weight 482 kg, total weight 640 kg, 105-HP Walter Minor 4 III engine, maximum speed 251 km/h, cruising speed 200 km/h, minimum speed 55 km/h, maximum ceiling 5,300 m, climb to 1,000 m 5 min. 55 sec, climb to 3,000 m 12 min, maximum range 600 km, endurance 4 hours.



Derived from the *R.G.-7* two-seater, the *R.G.-7 III* single-seater was built at the *Combinatul de industrializare a lemnului* of Reghin after the design of *Vladimir Novîtchi*. The test flights were carried out by pilot *Constantin Manolache*, one of Romania's specialists in aerobatics.

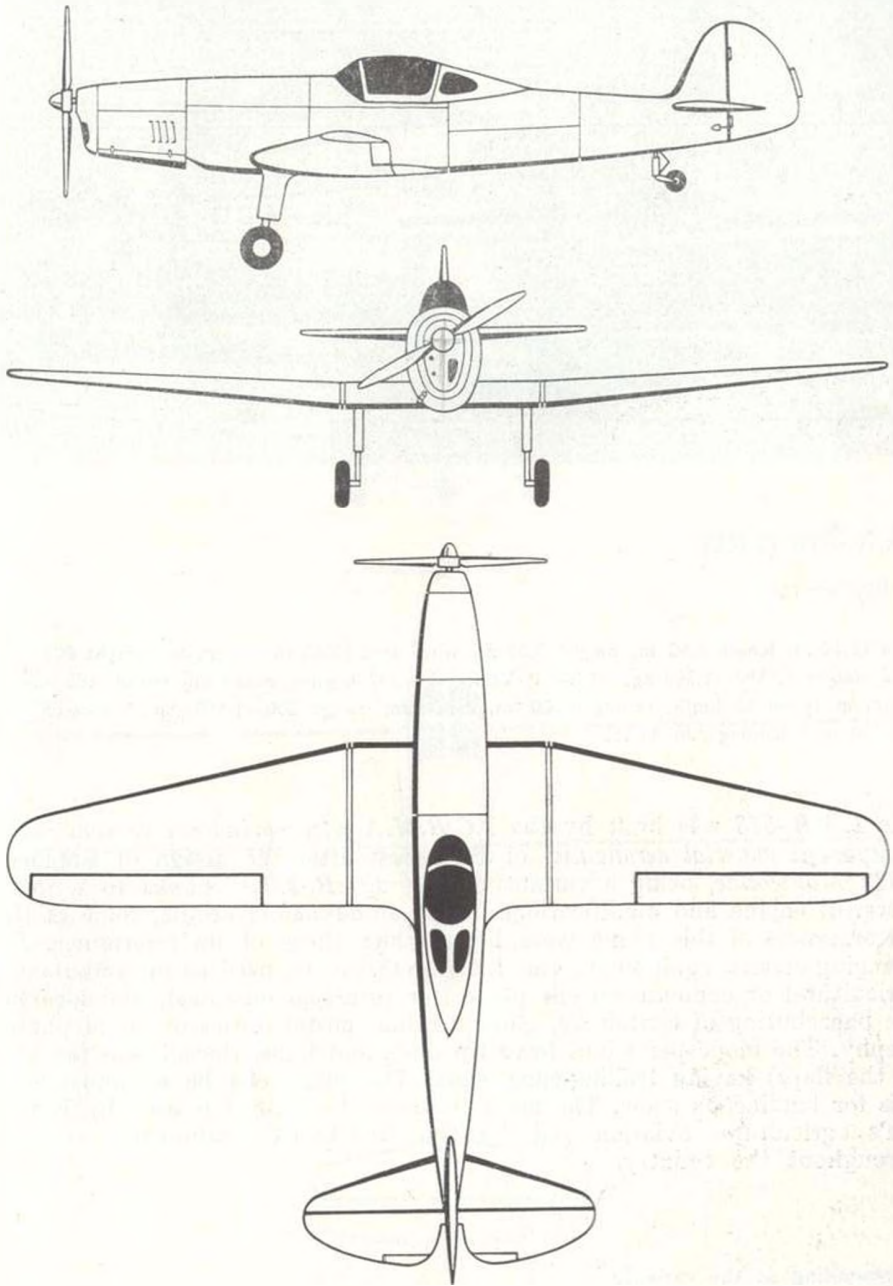





## I.A.R.-818 (1960)

Utility aircraft

Span 12.10 m, length 9.90 m, height 3.30 m, wing area 25.40 sq m, empty weight 805 kg, total weight 1,1180—1,300 kg, \* 170-HP Walter M. 337 engine, maximum speed 185 km/h, minimum speed 60 km/h, ceiling 4,000 m, maximum range 500—1,100 km, \* take-off run 80—100 m, \* landing run 40 m.

The *I.A.R.-818* was built by the *I.C.R.M.A. (Întreprinderea de construcții și reparații material aeronautic)* of Bucharest after the design of Engineer *Rudu Manicatide*, being a variant of the *I.A.R.-817*. Thanks to a more powerful engine and modifications in the aerodynamic profile, some of the performances of this plane were better than those of its forerunner. By changing certain equipments, the *I.A.R.-818* can be used as an ambulance, agricultural or communications plane (for principal missions), and also for the parachuting of containers, glider towing, postal duties or aerial photography. The monospar wings have tip discs and flaps, the ailerons (as well as the flaps) having trailing-edge slots. The plane can be equipped with skis for landing on snow. The mass-produced *I.A.R.-818* is used by Romania's agricultural aviation and by the *AVIASAN* (ambulance) stations throughout the country.

\* Depending on the variant.

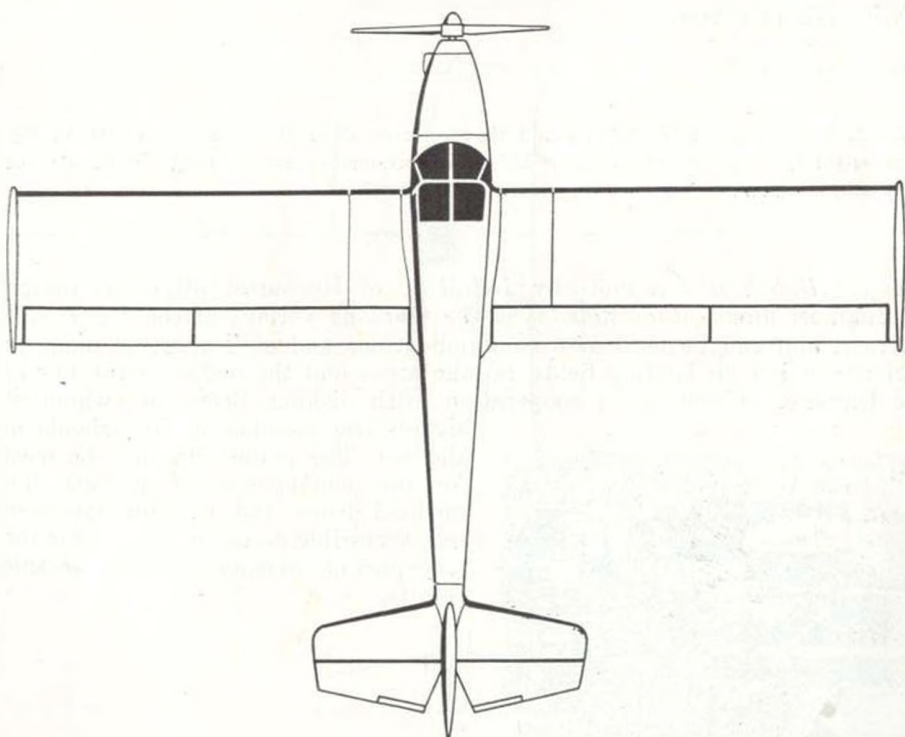
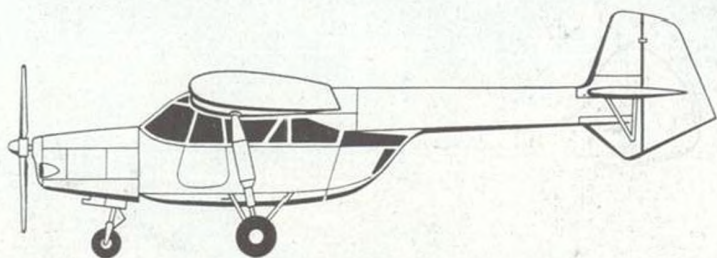



## I.A.R.-818 H (1964)

### Utility seaplane

Span 12.10 m, length 9.97 m, height 3.84, wing area 25.40 sq m, empty weight 880 kg, total weight 1,220 kg, 170-HP Walter M 337 engine, maximum speed 172 km/h, cruising speed 155 km/h, maximum ceiling 3,500 m, endurance 3—7 hours.

The *I.A.R.-818 H* was built by *I.R.M.A.* of Bucharest after the design of Engineer *Radu Manicatide*. It is the seaplane variant of the *I.A.R.-818* aircraft, and can be used as a communications and air-sea rescue plane in regions having no landing fields, in lake areas and the deltas as the one of the Danube, as well as for cooperation with fishing fleets, to whom it signals the presence of fish shoals in the sea. The plane can also be used for the conveyance of parcels and medical drugs and as ambulance in less accessible delta areas, and for the transport of passengers between seaside resorts.





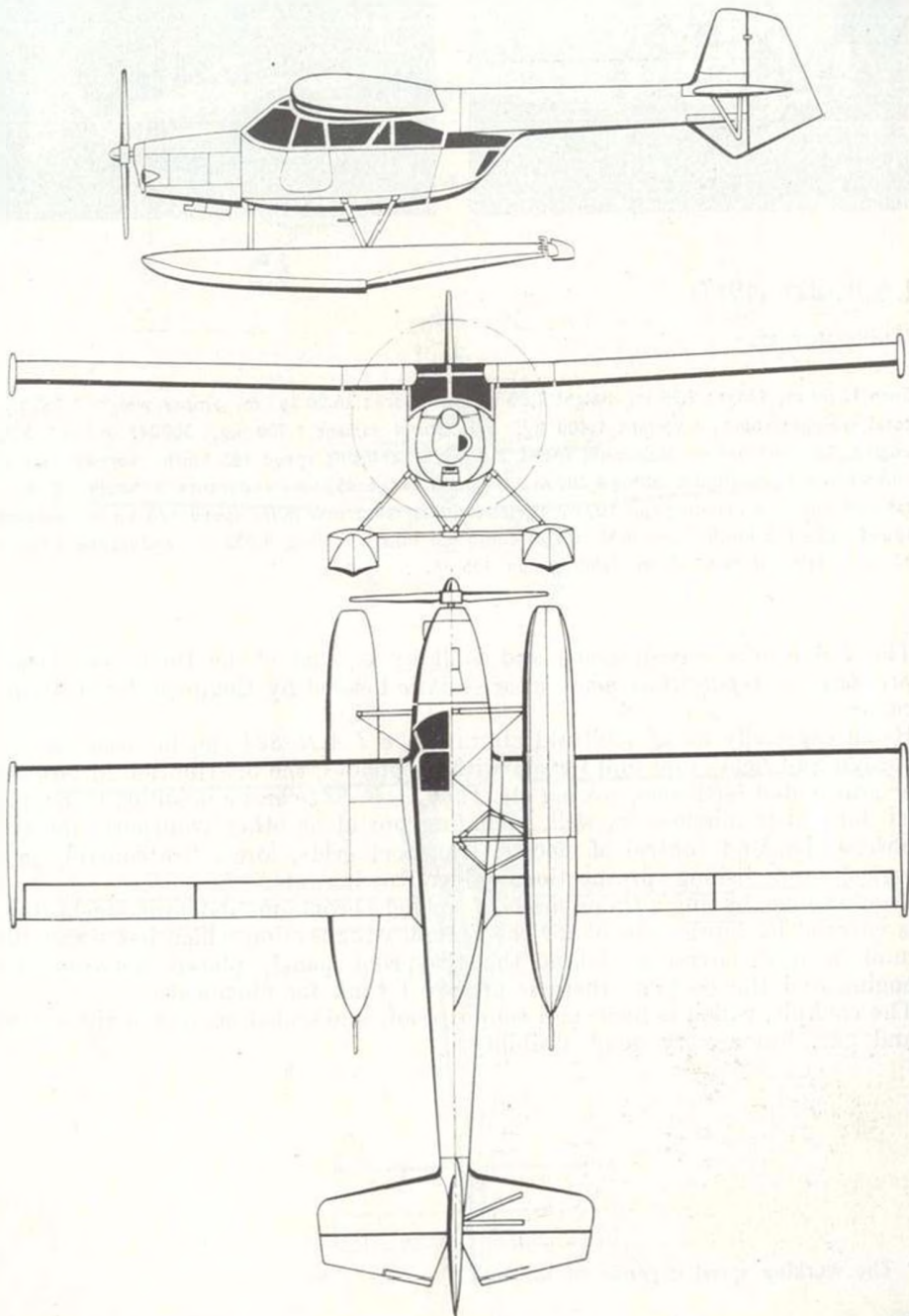



## I.A.R.-821 (1967)

### Utility aircraft

Span 12.80 m, length 9.20 m, height 2.80 m, wing area 26.00 sq m, empty weight 1.080 kg, total weight: *standard variant* 1,400 kg, *agricultural variant* 1,900 kg, 300-HP A.I.-14 R.F. engine. *Standard variant* maximum speed 215 km/h, cruising speed 185 km/h, vertical rate of climb 8 m.p.s., maximum ceiling 6,200 m, maximum range 450 km, endurance 2 hours 30 min, take-off run 60 m, landing run 100 m. *Agricultural variant*: maximum speed 170 km/h, working speed 120–155 km/h, \* vertical rate of climb 4.5 m.p.s., ceiling 4,000 m, endurance 2 hours 30 min, take-off run 135 m, landing run 135 m.

The *I.A.R.-821* was designed and built by a team of the Bucharest *Întreprinderea de reparații de material aeronautic* headed by Engineer Radu Manicatide.

Being especially an agricultural aircraft, the *I.A.R.-821* can be used for the spraying of field crops and forests with fungicides, the distribution of powder or granulated fertilizers, sowing etc. The *I.A.R.-821* can be modified or adapted for other missions as well, including postal or other transport, for the observation and control of electric transport grids, forest fire control, geological and fishing prospection, glider towing etc.

The fuselage, having a frame made of welded chrome-molibdenum steel tubes, is covered by fabric, except for the central wing section which has a duraluminium sheet covering. Behind the fire-proof panel, placed between the engine and the cockpit, there is an 800 l tank for chemicals.

The cockpit, which is heat- and sound-proof, and sealed against noxious dust and gas, has a very good visibility.

\* The working speed depends on the load.

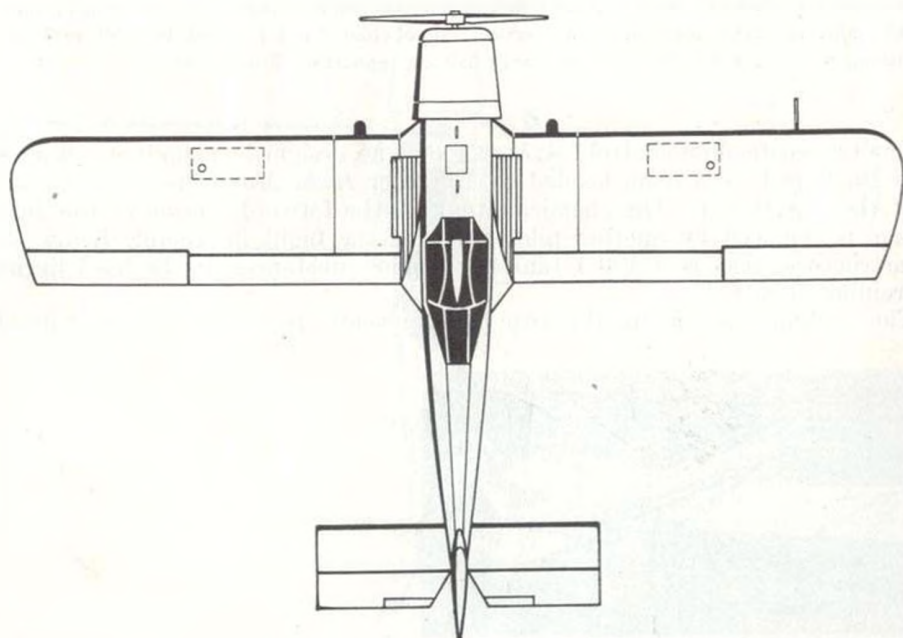
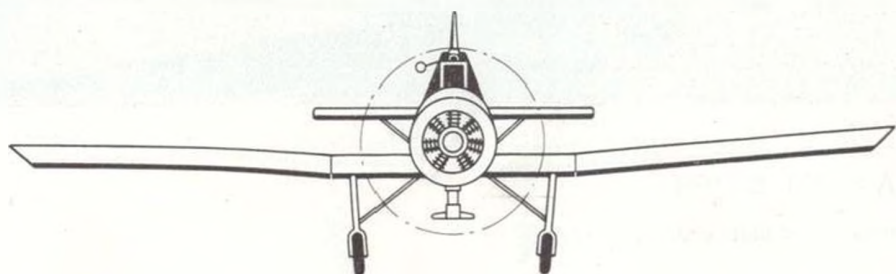
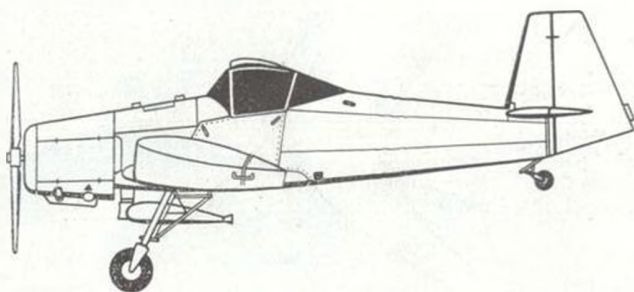





### I.A.R.-821 B (1968)

Primary and basic training aircraft

Span 12.80 m, length 9.20 m, height 2.80 m, wing area 26.00 sq m, empty weight 1,130 kg, total weight 1,500 kg, 300-HP A.I.-14 R.F. engine, maximum speed 220 km/h, cruising speed 185 km/h, minimum speed 60 km/h, vertical rate of climb 7 m.p.s., climb to 1,000 m 3 min, maximum ceiling 6,500 m, maximum range 650 km, endurance 3 hours 30 min.

The two-seater dual-control *I.A.R.-821 B* plane, designed and built at *I.R.M.A.* of Bucharest by a team headed by Engineer *Radu Manicatide*, is a variant of the *I.A.R.-821*. The chemicals tank in the forward section of the fuselage is replaced by another pilot seat, for the flight instructor. Below the instructor's seat is a 120 l tank for liquid substances to be used during training flights.

The cockpit, comprising the two tandem seats, is heat- and sound-proof.



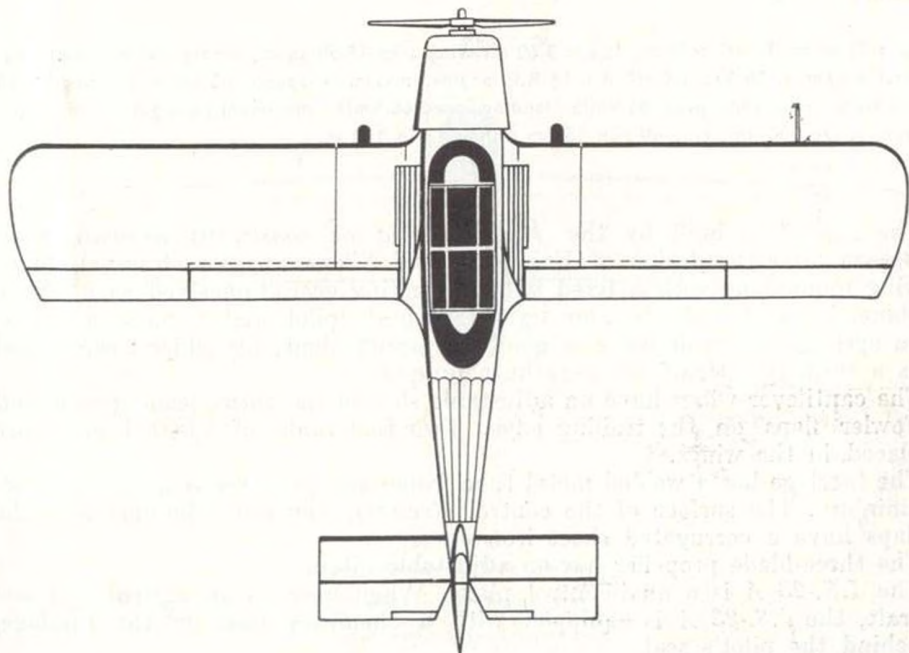
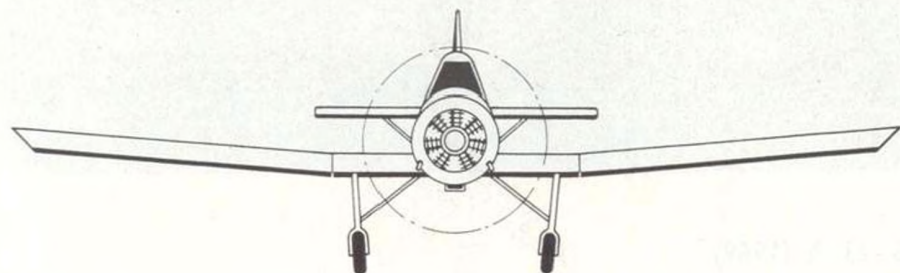
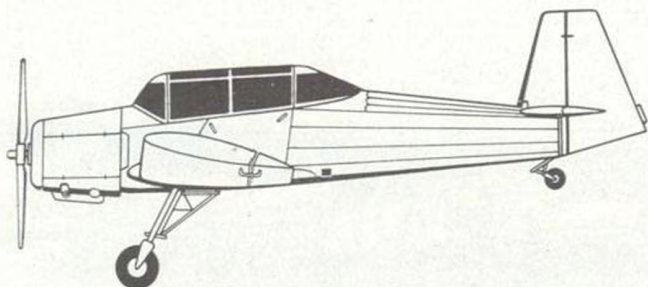



### I.S.-23 A (1969)

#### Utility aircraft

Span 12.40 m, length 9.10 m, height 3.60 m, wing area 19.50 sq m, empty weight 1,440 kg, total weight 2,100 kg, 300-HP A.I.-14 R.F. engine, maximum speed 205 km/h, cruising speed 180 km/h, minimum speed 85 km/h, landing speed 68 km/h, maximum ceiling 4,100 m, maximum range 600 km, take-off run 150 m, landing run 100 m.

The *I.S.-23 A*, built by the *Întreprinderea de construcții aeronautice* of Braşov after the design of Engineer *Iosif Şilimon*, is an all-metal, high-wing monoplane with a fixed tricycle landing gear. Conceived as a utility plane, it can be adapted for light transport (pilot and 5 passengers), as an agricultural, ambulance or goods transport plane, for glider towing, and as a training aircraft for parachute jumpers.

The cantilever wings have an adjustable slot on the entire leading edge and Fowler flaps on the trailing edge. Two fuel tanks of 1,000 l each are placed in the wings.

The fuselage has a welded metal tube frame and its cover is made of duraluminium. The surface of the controls (rudder, elevator, ailerons) and the flaps have a corrugated sheet iron cover.

The three-blade propeller has an adjustable pitch.

The *I.S.-23 A* is a dual-control plane. When used as an agricultural aircraft, the *I.S.-23 A* is equipped with a chemicals tank in the fuselage, behind the pilot's seat.



I. S.-23 A

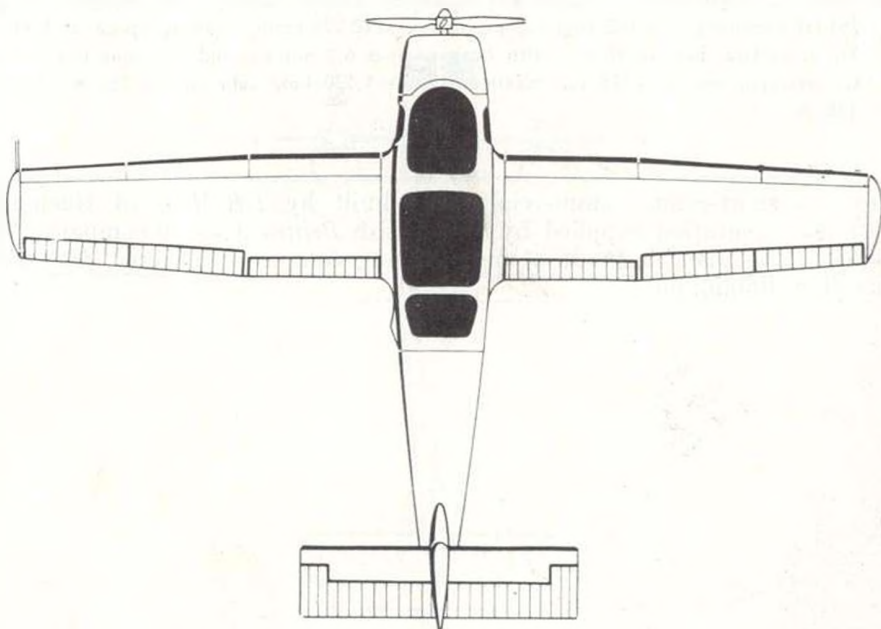
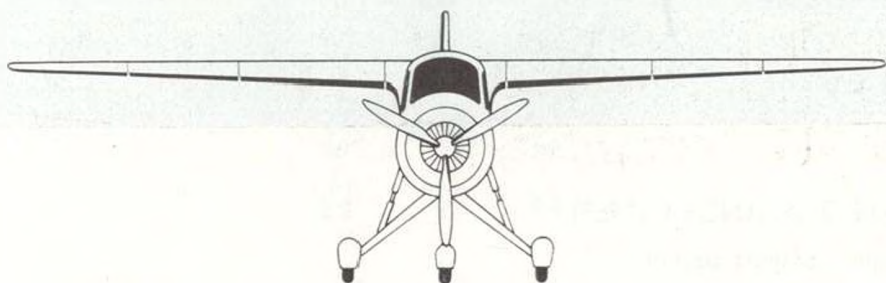
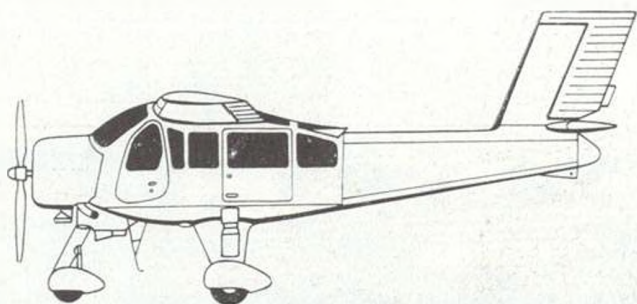



### B.N.-2 ISLANDER (1969)

Light transport aircraft

Span 14.92 m, length 10.90 m, height 4.16 m, empty weight 1,590 kg, total weight 2,590 kg, two 264-HP Lycoming O-540-E engines, maximum speed 270 km/h, cruising speed at 1,980 m 252 km/h, vertical rate of climb: with both engines 6.2 m.p.s., and with one engine 1.25 m.p.s., maximum ceiling 6,100 m, maximum range 1,130 km, take-off run 265 m, landing run 128 m.

This is a short-range commercial plane built by *I.R.M.A.* of Bucharest after documentation supplied by the British *Britten Norman* company. The frame of the plane is made of metal, being completely covered with anti-corrosive aluminium.

B. N.-2 ISLANDER

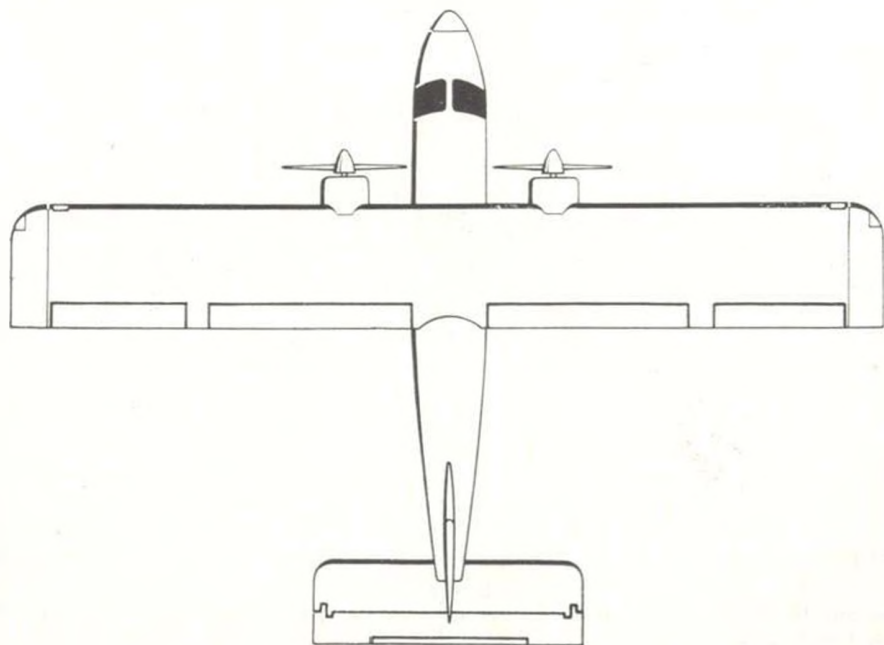
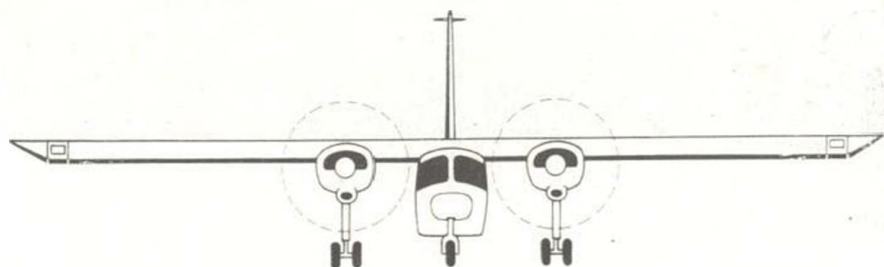
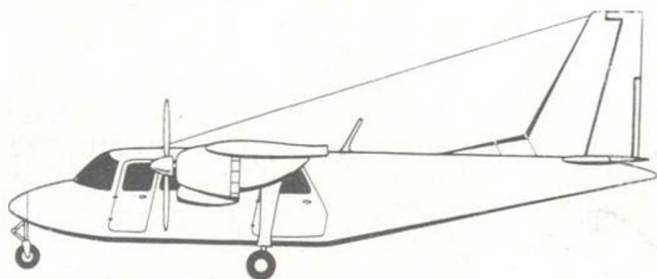





## I.A.R.-822 (1970)

### Agricultural aircraft

Span 12.80 m, length 9.40 m, height 2.80 m, wing area 26.00 sq m, empty weight 1,120 kg, total weight 1,900 kg, 290-HP Lycoming IO-540 G1 D5 engine, maximum permitted speed 230 km/h, working speed 120-160 km/h, minimum speed 65 km/h, maximum ceiling 4,500 m, maximum range 350 km, endurance 2 h 20 min.

The *I.A.R.-822* was built by *I.R.M.A.* of Bucharest after a design made at the *Institutul de mecanica fluidelor și construcții aerospațiale* by a team headed by Engineer *Radu Manicatide*. This is a plane built especially for agricultural operations. It is a mixed construction low-wing monoplane. The frame of the fuselage is made of welded chrome-molybdenum steel tubes. The forward section of the fuselage is covered with duraluminium panel and the rearward section with fabric. An 800 l tank for liquid or solid chemicals is placed in the fuselage between the cockpit and the fire-proof panel.

The wings, with a frame made of timber spars and ribs, are covered with plywood and fabric (on the plywood).

The frame of the tail unit is made of wood, the fixed fin and stabilizer being covered with plywood, and the rudder and elevator with fabric.

The *I.A.R.-822* agricultural aircraft is used for the distribution of chemical fertilizers (solid or liquid); the protection of crops by chemical spraying or dusting; sowing; the control of agricultural land and forests.

During the year 1973 an all-metal version of this aircraft was built, under the heading *I.A.R.-826*.

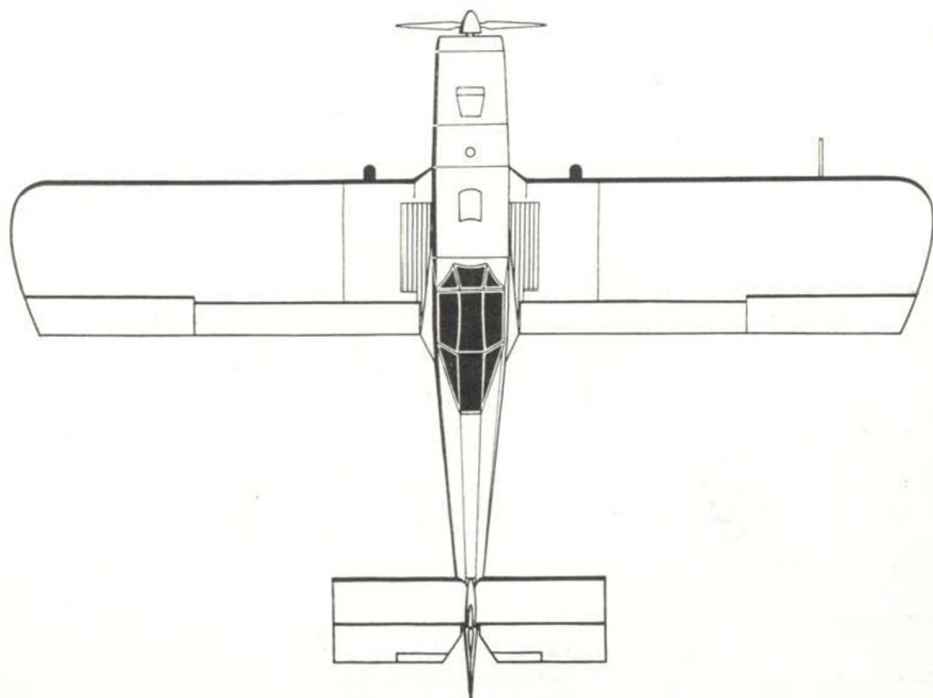



## I.A.R.-824 (1971)

### Utility aircraft

Span 12.40 m, length 9.20 m, height 3.30 m, empty weight 1,240 kg, total weight 1,900 kg, payload 660 kg, 290-HP Lycoming IO-540 G1D5 engine, maximum speed 200 km/h, cruising speed 180 km/h, minimum speed 75 km/h, service ceiling 3,000 m, take-off run 190 m, landing run 110 m, maximum range (with 30-minute reserve) 800 km.

Designed by a team headed by Eng. *Iosif Şilimon* and built at the *Întreprinderea de construcții aeronautice (I.C.A.)* of Braşov, the *I.A.R.-824* is a multi-purpose utility machine and can be equipped for various missions: passenger transport (6 places), light freight transport, ambulance, para-jump training platform, glider towing and aerial photo work. The *I.A.R.-824* is an all-metal machine made of light alloys. The wing (NACA 642-415 foil) is placed over the fuselage; it is a one-piece structure with two spars, ribs, and stringers. The flaps are electrically actuated; the double ailerons have differential deflection in combination with the flaps. The monocoque fuselage has frames, longitudinal stringers and integral covering, access to the cabin being provided by two lateral doors, one on each side, plus a sliding door on the left. The fixed three-wheel landing gear has the frontal castor controlled by the rudder pedals. The landing gear has hydro-pneumatic shock-absorbers and hydraulic brakes.

The metal tail unit contains a controlled rudder trimmer and its stabilizer is adjustable in flight.

The engine's cowlings are of metal and fibreglass. The aircraft has a 24 V electric system for feeding the dashboard, position lights, landing projector and flap control device. A 400 Hz converter feeds the gyroscopic apparatus, and 360 channel Bendix COMM RT-221 assures radio communications.



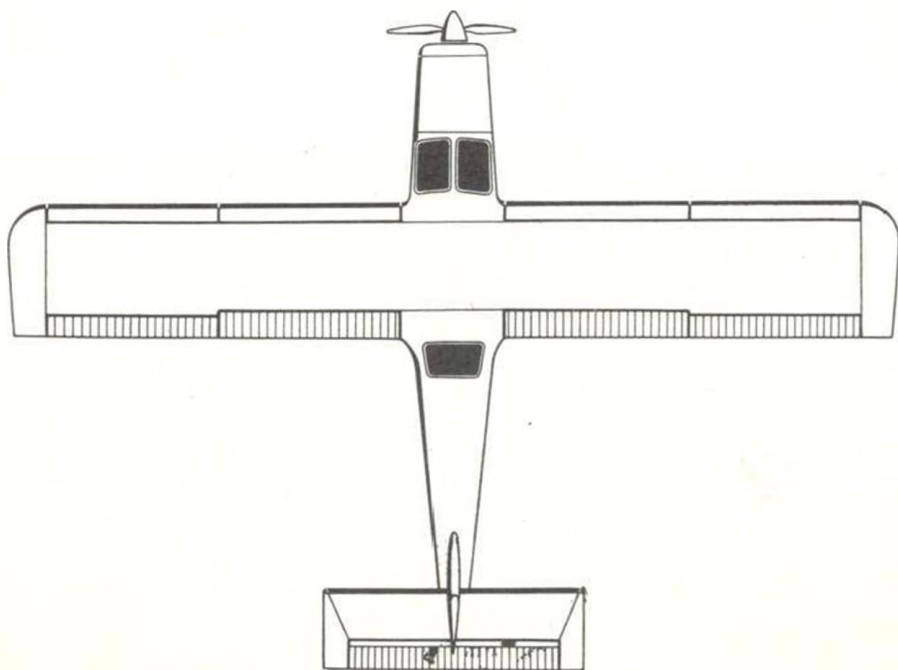
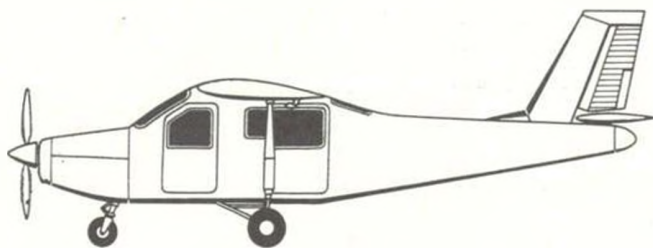

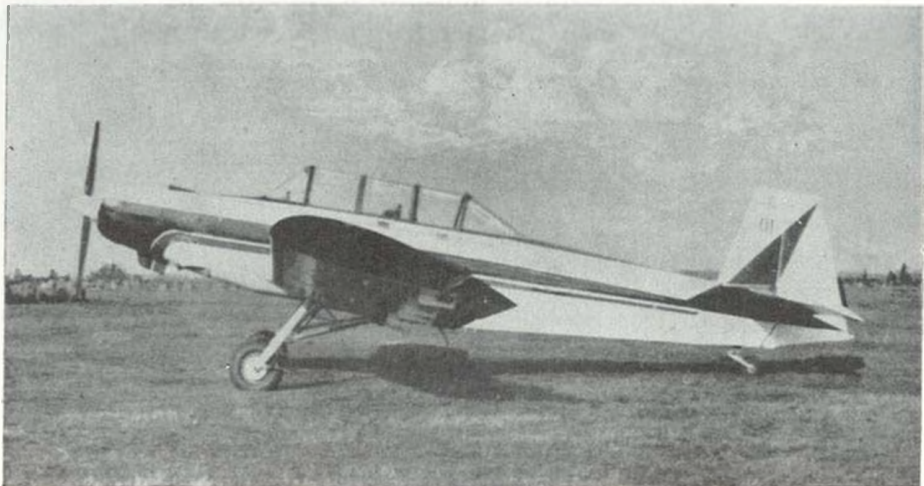

### I.A.R.-822 B (1973)

Primary and basic training aircraft

Being a variant of I.A.R.-822 (1971), only the different data are tabulated: empty weight 1,180 kg, total weight 1,550 kg, cruising speed 220 km/h, minimum speed 60 km/h, maximum ceiling 7,000 m, endurance 5 h.

This variant was made by a team of the *Întreprinderea de reparat material volant (I.R.M.A)* of Bucharest.

It is a tandem two-seater, modifications consisting in the creation of room for the pupil in front of the pilot (now instructor) where the chemicals tank was.

The cockpit offers perfect visibility at taxi roll and during flight.

The fuselage is aluminium covered, and the controls and trimmer are electrically actuated.

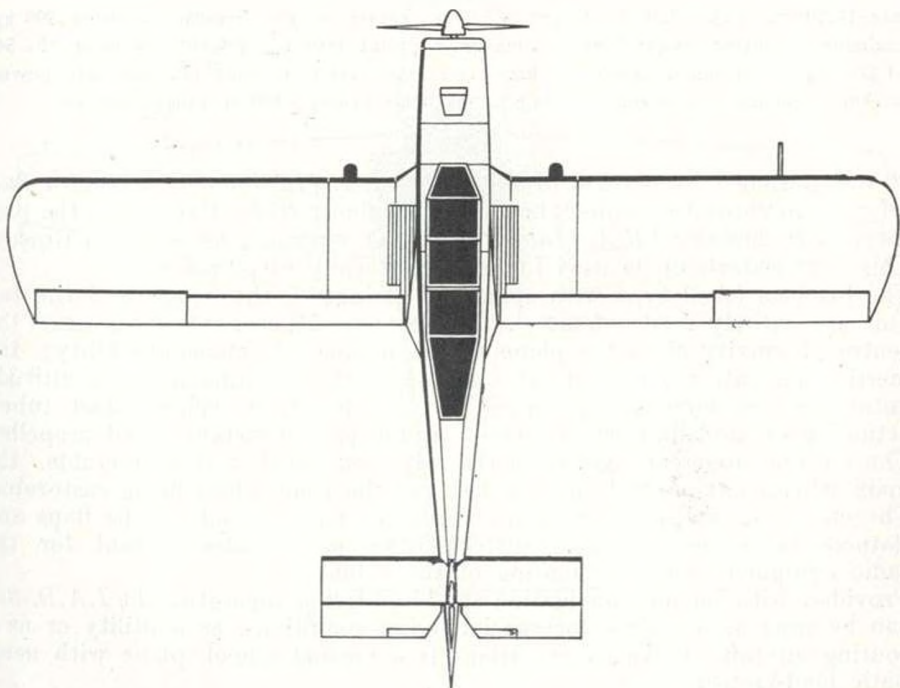
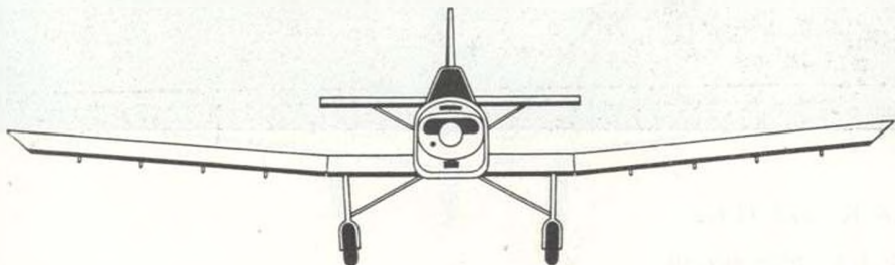
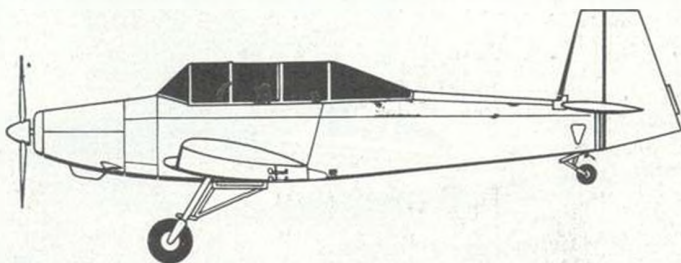





### I.A.R.- 823 (1973)

Multi-purpose aircraft

Span 10.00 m, length 8.24 m, height 2.52 m, empty weight (standard variant) 900 kg, maximum permitted weight 1,500 kg, maximum payload 600 kg, 290-HP Lycoming 10-540 G1 D5 engine, maximum speed 310 km/h, maximum cruising speed (75 per cent power) 300 km/h, vertical rate of climb 7.5 m.p.s., maximum ceiling 5,600 m, range 1,800 km.

It was designed by a team of the *I.M.F.C.A. (Institutul de mecanica fluidelor și construcții aerospațiale)* headed by Engineer *Radu Manicatide*; the prototype was made by *I.C.A. (Intreprinderea de construcții aeronautice)* Brașov. This four-seater can be used for a great variety of purposes.

The fuselage (shell type with spars and stringers), the wings, and the tail unit are entirely made of metal. The concentration of loading near the centre of gravity gives the plane a high degree of manoeuvrability; the inertia moments are limited. The engine, with fuel injection and altitude automatic trimming, is suspended on a support of welded steel tubes, actioning a two-blade Hartzell metal variable pitch constant speed propeller. The tricycle undercarriage is electrically controlled and retractable, the main wheels having hydraulic brakes and the front wheel being castorable. The electrical system of the plane starts the engine, controls the flaps and flatners, feeds the navigation instruments and provides current for the radio equipment and the lighting of the cabin.

Provided with modern navigation and blind flying apparatus, the *I.A.R.-823* can be used as a trainer for special flying conditions, as a utility or as a touring aircraft; its two-seater variant is a normal school plane with aerobatic load-factors.

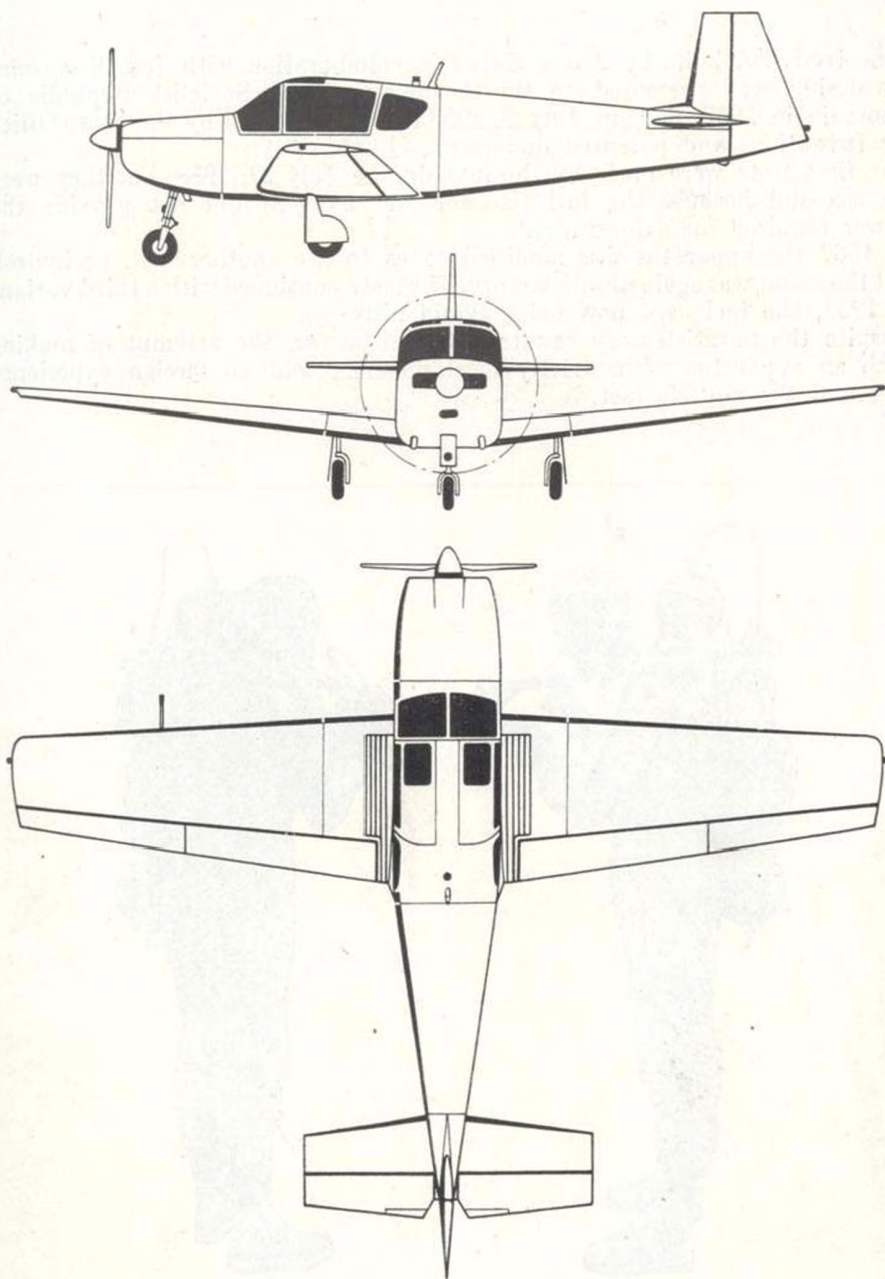

## PORTABLE EXPERIMENTAL APPARATUS FOR INDIVIDUAL FLYING

Conceived and built by *Justin Capră* in collaboration with *Ion Munteanu*, the design was presented to the Academy of the Socialist Republic of Romania in 1957, and on July 8, 1958 it was registered by the State Office for Inventions and patented under No. 41,711.

The first tests were made by the inventor on July 27, 1958, but they were unsuccessful because the fuel (alcohol and oxygen) did not provide the power required for a long flight.

In 1967 the apparatus was modified so as to use another fuel, perhydrol, but the result was again unsatisfactory. The tests continued with a third variant in 1968, the fuel used now being liquid nitrogen.

Despite the unsatisfactory results obtained so far, the attempt of making such an apparatus with strictly local means — and no foreign experience — remains a notable fact.

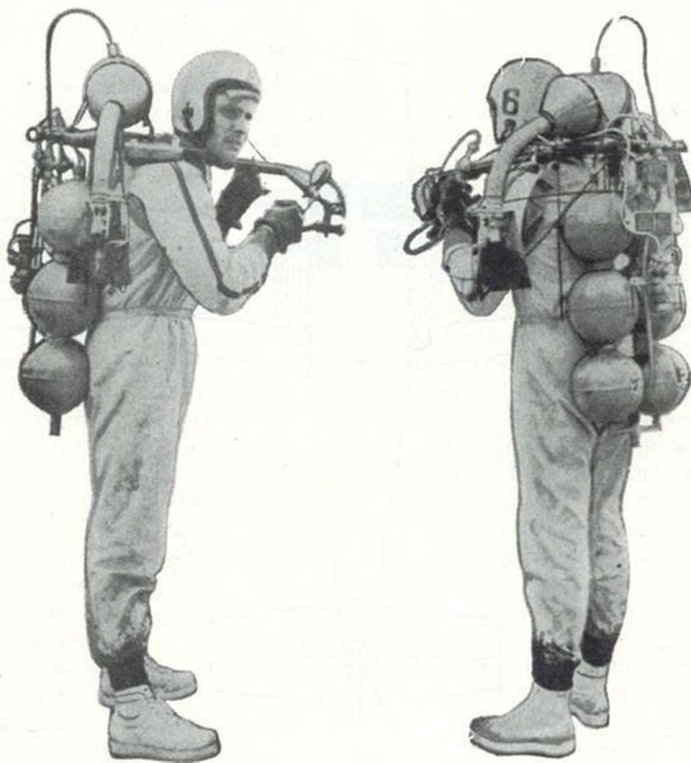



# HELICOPTERS

11

The following information is for your information only. It is not intended to be used as a basis for any action. It is the property of the Department of Defense and is loaned to you for your information only. It is to be returned to the Department of Defense upon request. It is not to be distributed outside your organization. It is not to be used for any purpose other than that for which it was provided. It is not to be used in any way that would reflect unfavorably on the Department of Defense or the United States Government. It is not to be used in any way that would be detrimental to the national defense. It is not to be used in any way that would be in violation of any law, regulation, or executive order. It is not to be used in any way that would be in violation of any policy or procedure of the Department of Defense. It is not to be used in any way that would be in violation of any contract or agreement. It is not to be used in any way that would be in violation of any other applicable law, regulation, or executive order. It is not to be used in any way that would be in violation of any other applicable policy or procedure. It is not to be used in any way that would be in violation of any other applicable contract or agreement. It is not to be used in any way that would be in violation of any other applicable law, regulation, or executive order. It is not to be used in any way that would be in violation of any other applicable policy or procedure. It is not to be used in any way that would be in violation of any other applicable contract or agreement.

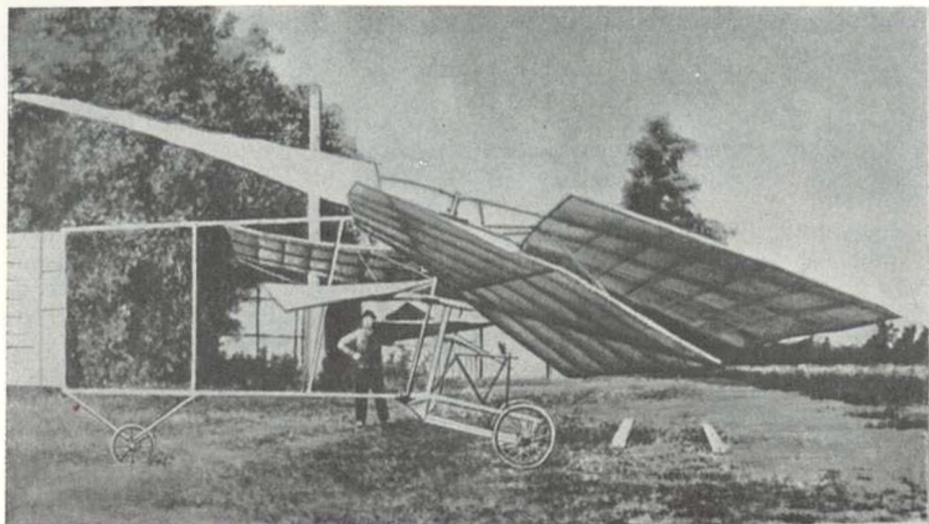

### The VUIA No. 1 Helicopter (1918)

Rotor diameter 6.50 m (2 groups of rotors), rotor disk area 32.00 sq m, total weight of helicopter 120 kg.

Designed and built by *Traian Vuia*, the *Vuia Nr. 1* Helicopter was an experimental machine with two groups of rotors, each group having two superimposed rotors with two blades, each rotating in opposite directions. The two groups of rotors were placed at the end of a metal frame made of steel and duraluminium tubes.

The helicopter moved horizontally by dipping the axis of the rotors; in this position the rotors provided both sustentation and propulsion. Both groups of rotors were coupled to the same shaft by transmission gears. The frame of the blades was made of metal and was similar to that of ordinary wings, the cover being of cloth. The controls, rudder and elevator were in the rear part of the helicopter.

The *Vuia Nr. 1* Helicopter had no engine. The rotors were moved by human power. The helicopter was tested in 1920 on the field of Juvisy. The blades rotated at a speed of 37 rotations per minute, equivalent to a sustaining power of 57 kg on the soil. During this test the rotors were powered by means of pedals actioned by cyclist *Gaston Dégy*.

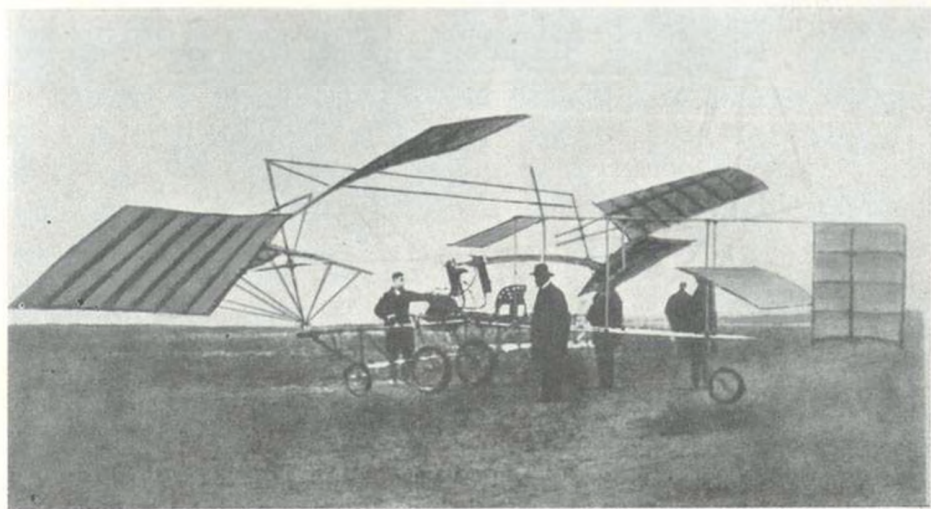

The VUIA No. 2 Helicopter (1921)

The second helicopter built by *Traian Vuia* had rotors of the same size and structural features as the *Vuia Nr. 1*. Vuia mounted an 8-HP engine on this helicopter. The first trials were made on March 18, 1922, on the field of Juvisy by the French pilot *Laurent*. During these experimental flights, only a few take-offs were carried out because the strip was very small. Afterwards Vuia took his helicopter to the field of Issy-les-Moulineaux where, after a few attempts, he realized that the engine could not provide the power needed for the take-off of the helicopter. He therefore replaced it with a 16-HP four in-line cylinder *Anzani* engine and also made some structural changes, for instance the replacement of the cloth-shell of the rotor blades with a timber covering. The test flights were resumed in the autumn of 1925, the helicopter being first piloted by *Laurent* and afterwards by Vuia's friend and co-worker *Marcel Yvonneau*. Placed over winter in a hangar at Issy-les-Moulineaux, the helicopter was found there one day almost completely destroyed. This, together with the lack of financial means, put an end to the highly interesting helicopter developments of Traian Vuia.





### C.O.-2 (1938)

#### Experimental helicopter

The rotor diameter 8.00 m, diameter of the anti-torque propeller 1.80 m, length 7.30 m, height 3.20 m, total area of the rotor blades 5.76 m, number of rotor revolutions 188 r.p.m., total weight 410 kg, 90-HP Pobjoy-Niagara engine, reduction rate 19.40, horizontal calculated speed 132 km/h.

In 1934 Major *Cristea Constantinescu* (B.Sc., Eng.) designed an auto-gyro-helicopter, called *C.O.-1*, with a pusher airscrew and two co-axial rotors. Having tested a model of the aircraft and being dissatisfied with the over-complicated construction of the two rotors Eng. Constantinescu designed the *C.O.-2* helicopter. In 1938 the finalized design was submitted to the Air and Navy Ministry, after the successful testing of the helicopter's mock-up in the wind tunnel of the Polytechnical Institute of Bucharest. One of the rotors of the helicopter, built to size and attached to the engine, successfully passed ground tests on the proving stand before a commission of the Ministry, giving the results specified by the design.

Although the *C.O.-2* helicopter was not completed because of lack of funds, its design was a valuable advance, the main point of interest residing in the original conception and the new structural solution found for it (two co-axial rotors, anti-torque propeller, aerodynamic cockpit etc.). Unlike the helicopters built and tested at the time (Breguet-Dorand and Focke-Wulf F.W. 61), the *C.O.-2* helicopter, although designed more than 30 years ago, was very similar to the helicopter models built today.

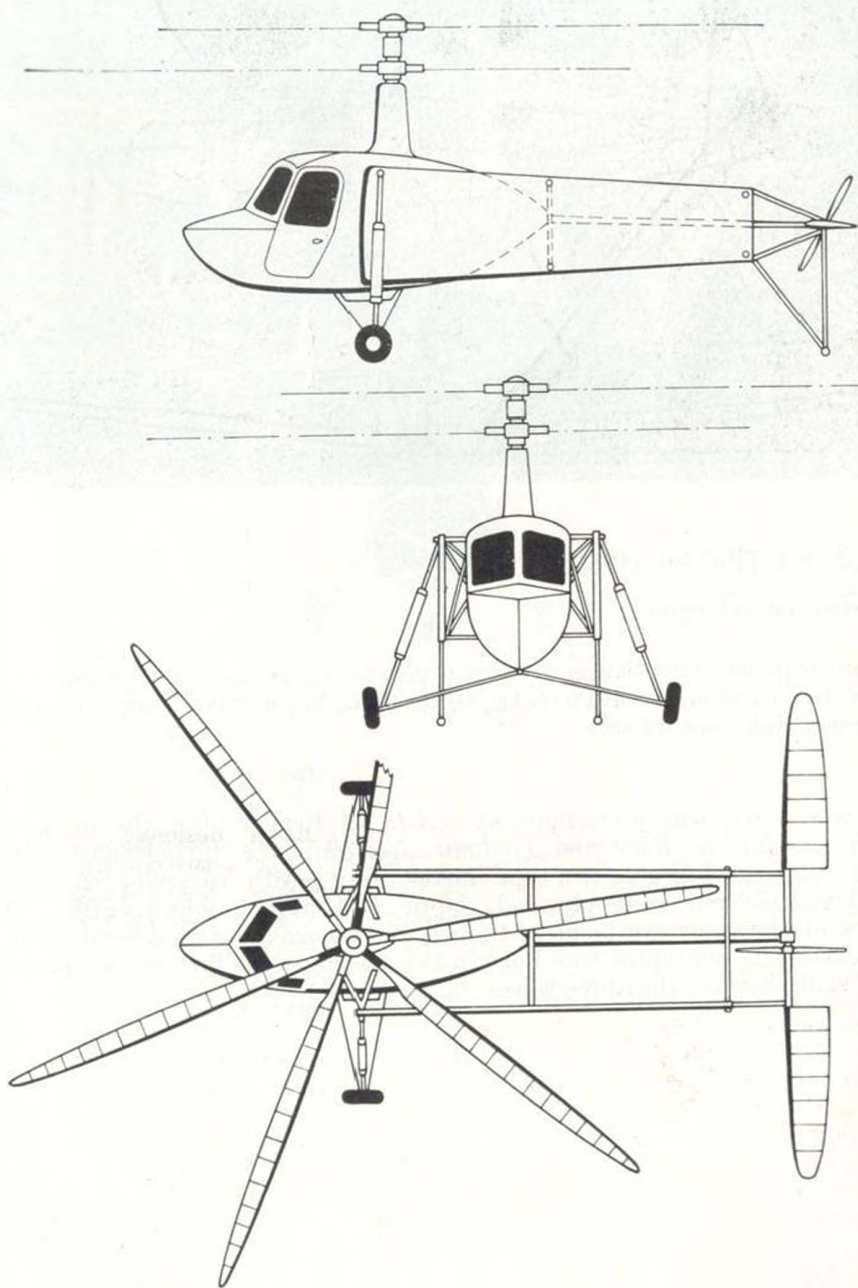



### R.G.-8 H1 ȚÎNȚAR (1960)

Experimental helicopter

Diameter of the main rotor 10.50 m, diameter of the anti-torque propeller 1.80 m, total length 8.99 m, height 2.50 m, total weight 660 kg, payload 188 kg, 105-HP Walter Minor 4 III engine, maximum (rated) speed 136 km/h.

The *R.G.-8 H1* helicopter, built by *C.I.L.* of Reghin after the design of Engineer *Gheorghe Rado* and *Vladimir Novîțchi*, is a mixed construction the fuselage having a lattice-type metal frame with two wooden spars, and being covered with plywood, fabric and duraluminium sheets. The blades of the rotor are made of timber, and so are those of the anti-torque propeller. The helicopter was built in two variants, the first being equipped with skids besides the three-wheel landing gear.



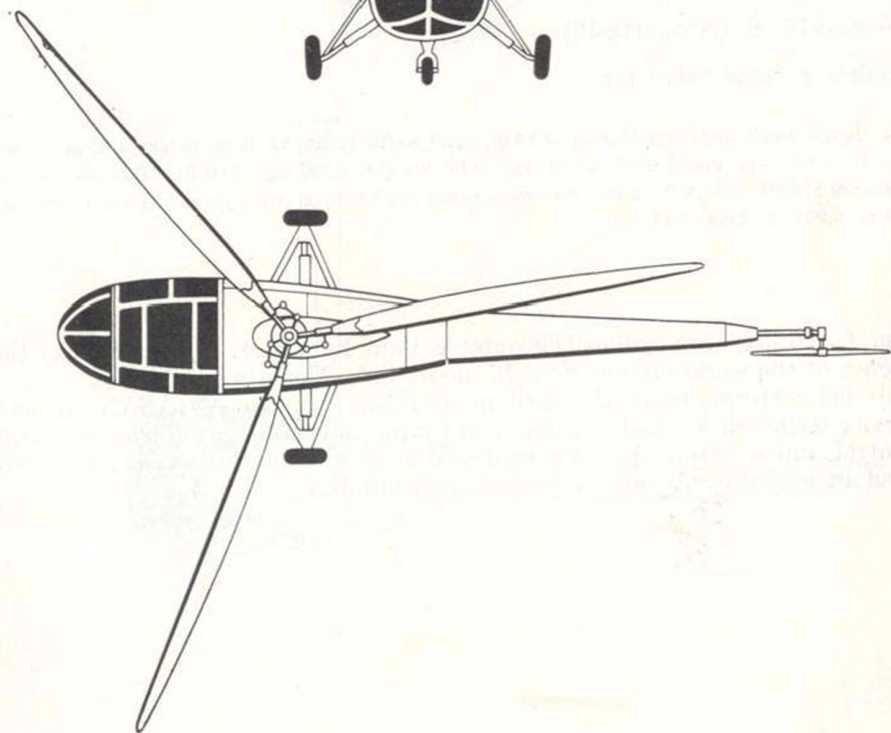
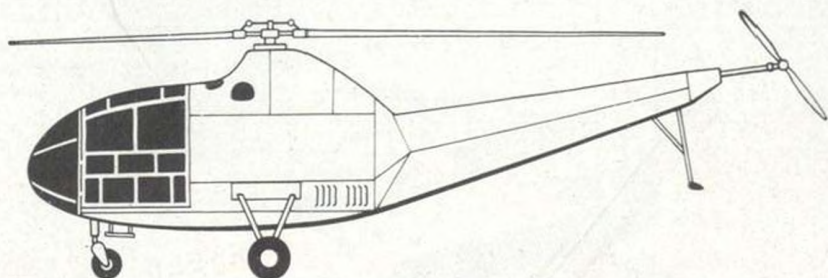



### I.A.R.-316 B (Alouette-III) — (1972)

Multiple purpose helicopter

Total length (including rotor blades) 12.84 m, total width (ditto) 11.02 m, height 3.00 m, empty weight 1,122 kg, useful load 1,078 kg, total weight 2,200 kg, TURBOMECA-Artouste-III engine of 570 HP at 33,500 r.p.m., maximum speed 210 km/h, cruising speed 185 km/h, absolute ceiling 5,900 m, range 530 km.

The *I.A.R.-316 B* medium helicopter is built by *I.C.A.* of Braşov after the licence of the world-famous French model *S.A.-Alouette III*. This helicopter is currently used in Romania by the *AVIASAN* (health service aviation) central station, and by the Militia (police) highway traffic control units. Also, specially equipped machines of this type are widely used in agricultural and sea-rescue applications.

I.A.R.-316 B (Alouette-III)

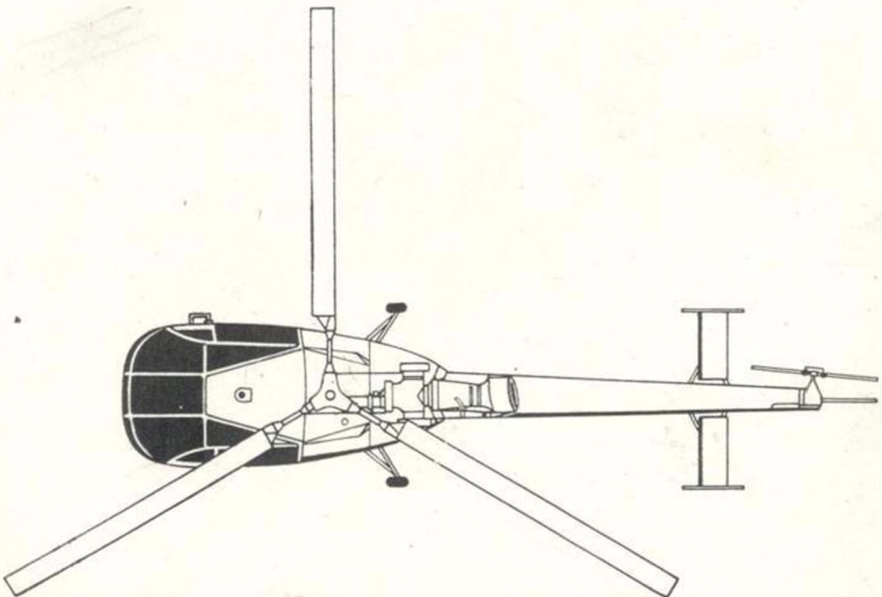
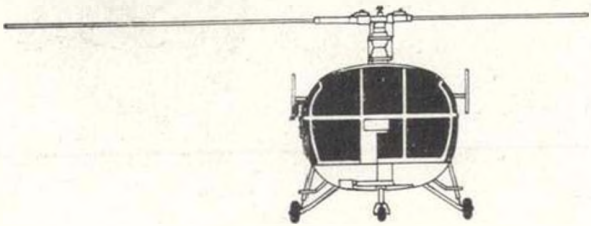
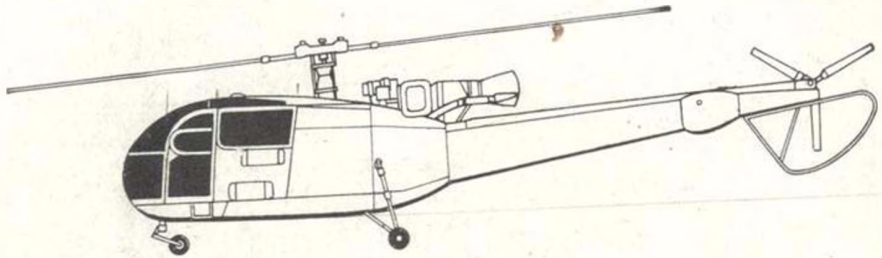





Faint, illegible text, possibly a title or a list of items, located in the middle section of the page.



GLIDERS

---

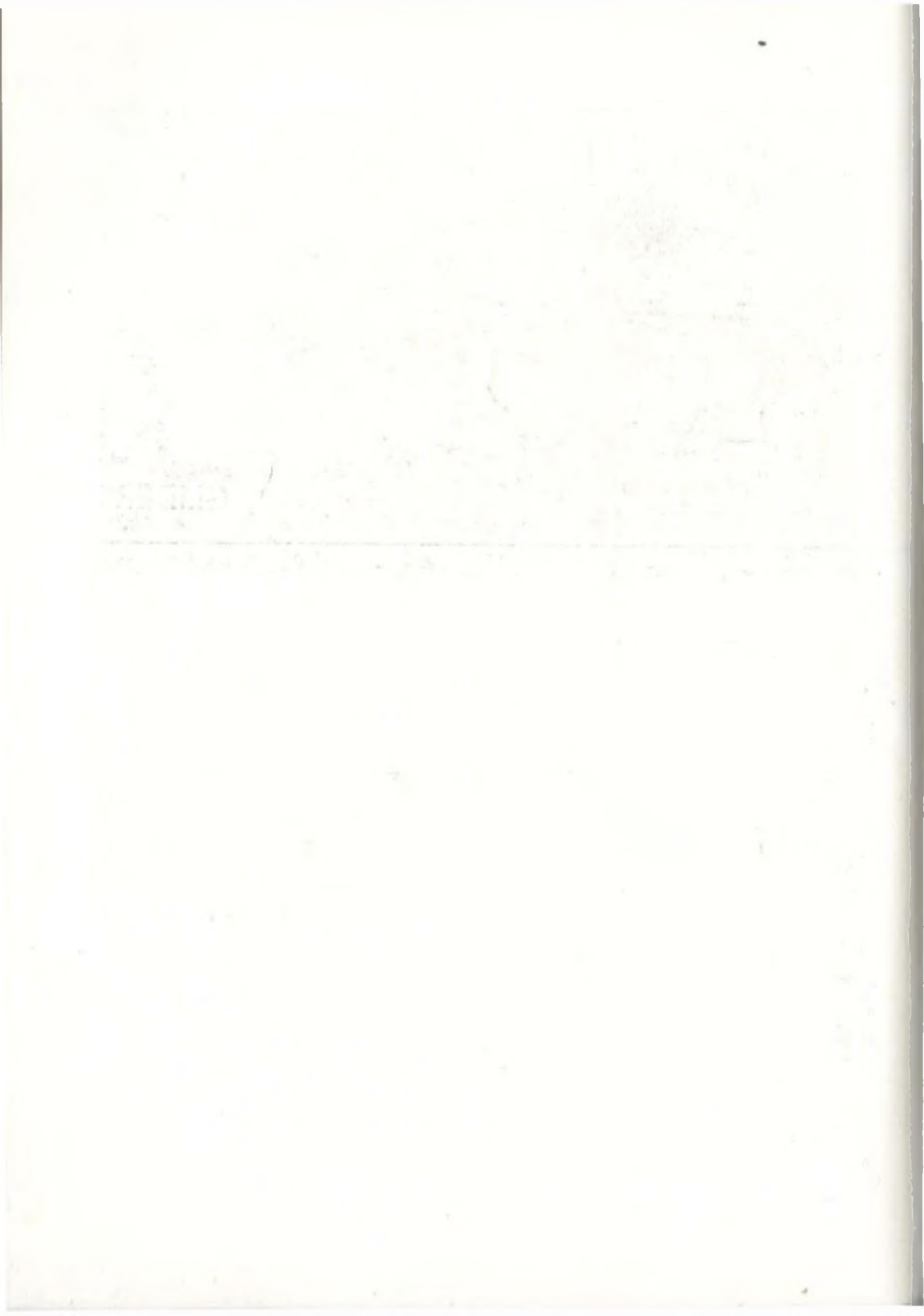



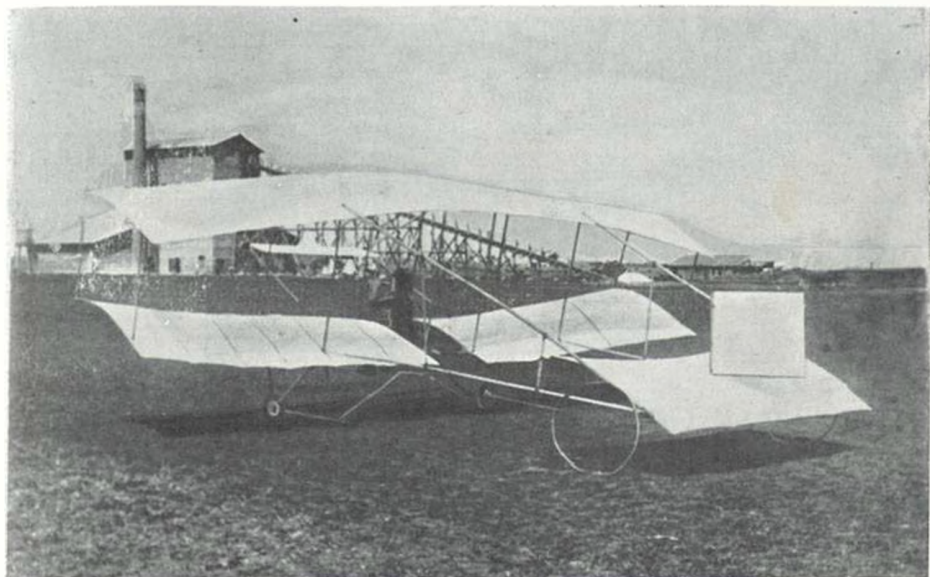

### THE GLIDER OF HENRI AUGUST (1909)

Span 7.00 m, length 9.20 m, wing area 22.35 sq m, empty weight 16.50 kg.

This glider was built in 1909 by young *Henri August*, quite rightly considered one of the pioneers of gliding in Romania. Being the result of experiments made with scale models, the glider was a double decker, with a metal frame made of welded steel tubes and partially covered with fabric.

The test flights were made on a field near the village of Pantelimon, on the outskirts of Bucharest. Towed by a motor-car, the glider took off easily and had a good stability. Shortly afterwards the glider was destroyed under the wreckage of a warehouse used by Henri August as a hangar, and which collapsed during a storm.

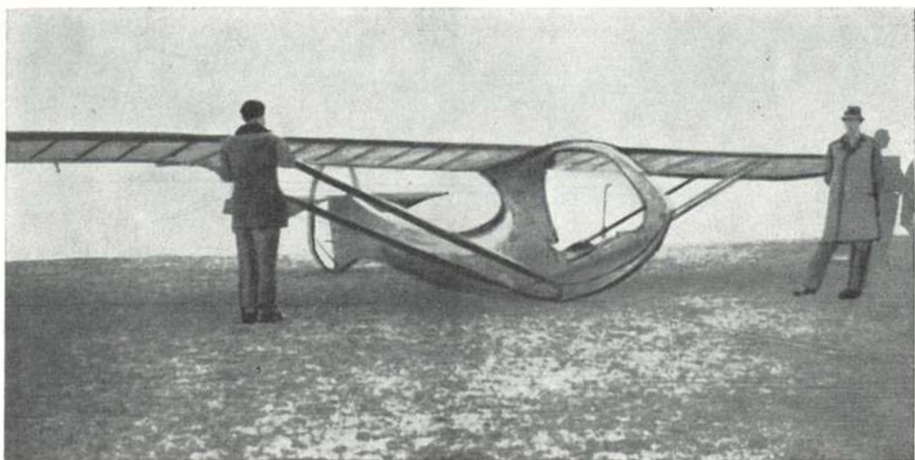

## G.E.P. (1939)

### Basic training glider

Span 10.00 m, length 5.55 m, empty weight 70 kg, total weight 140 kg, lift drag ratio 11.00, minimum sinking speed 1.00 m/sec, maximum permitted tow speed: winch 70 km/h.

The *G.E.P.* was designed and built by *George Popoiu*. The main feature of this glider was the simple fuselage made entirely of plywood. The frame of the wings was made of timber and the cover of fabric. The simplicity of the structure and the unsophisticated material needed for it made it possible to manufacture the *G.E.P.* in any gliding centre.

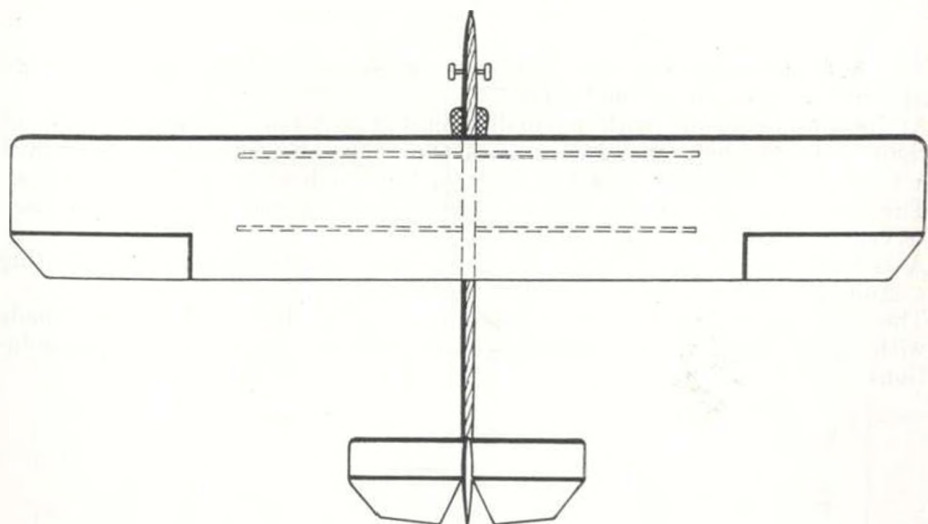
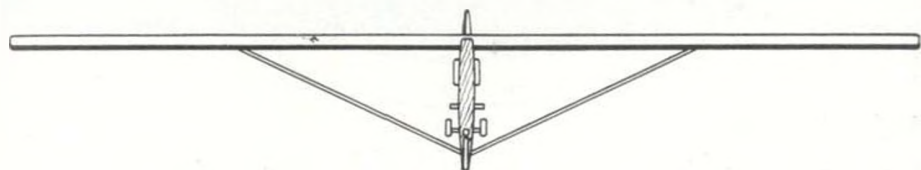
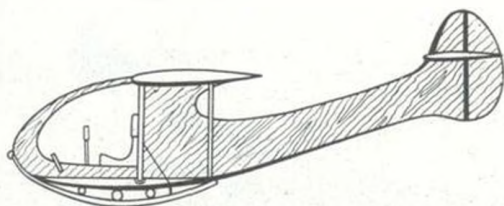



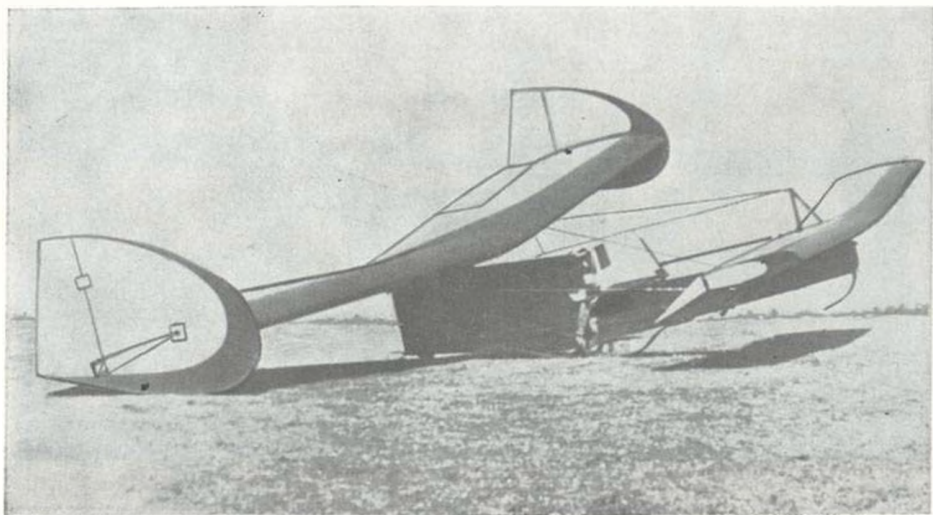

### R.M.-10 (1943)

#### Experimental sailplane

Span of the main wing 6.00 m, span of the front wing 3.00 m, wing area 9.00 sq m, empty weight 60 kg, total weight 130 kg.

The *R.M.-10* experimental sailplane, designed and built by Engineer *Radu Manicatide*, had an original form.

At its tips the wing (with a small aspect ratio) had a marginal disc at right angle to the transversal axis of the sailplane. Each of the discs had a fixed part, designed to act as a fin, and a mobile part, acting as a rudder. The two rudders could be controlled separately as well, in which case they served as aerodynamic brakes.

A shorter wing (canard) was placed in front of the fuselage, comprising a stabilizer and an elevator.

The conclusions drawn upon examination of the films of the flights made with the *R.M.-10* at the Sinpetru gliding centre confirmed the original solutions applied in this formula of sailplane construction.

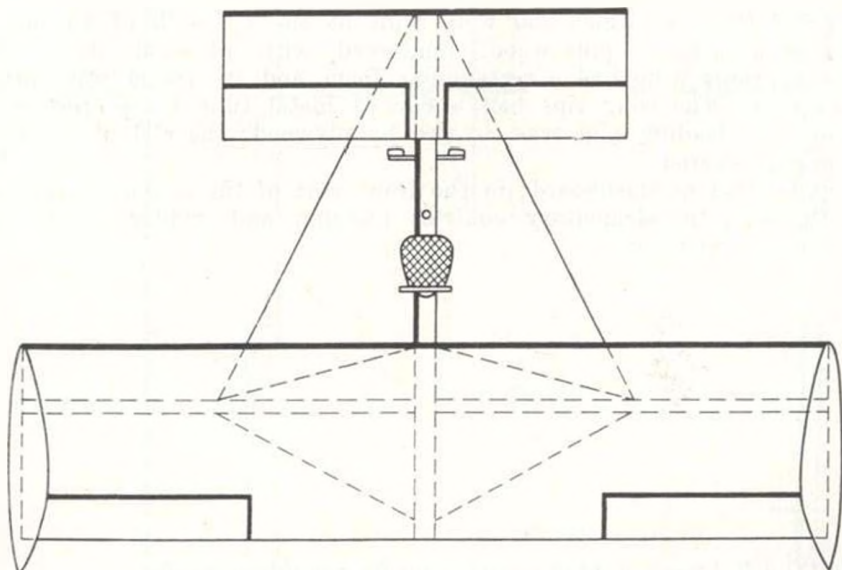
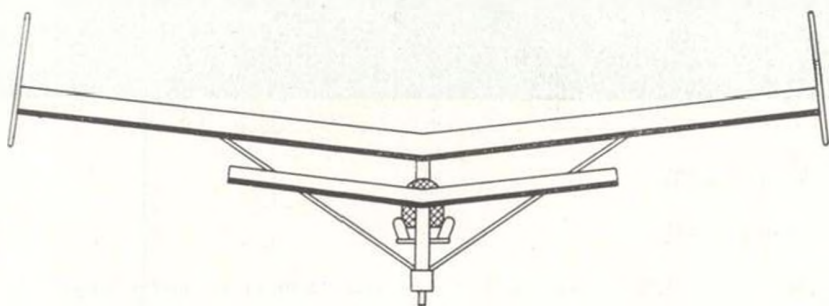
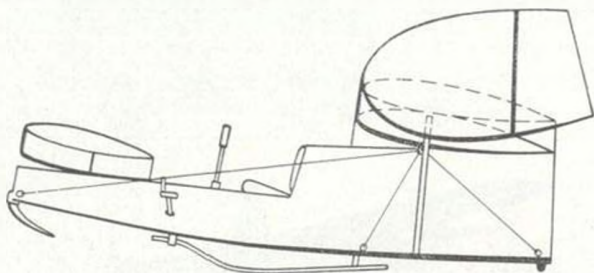

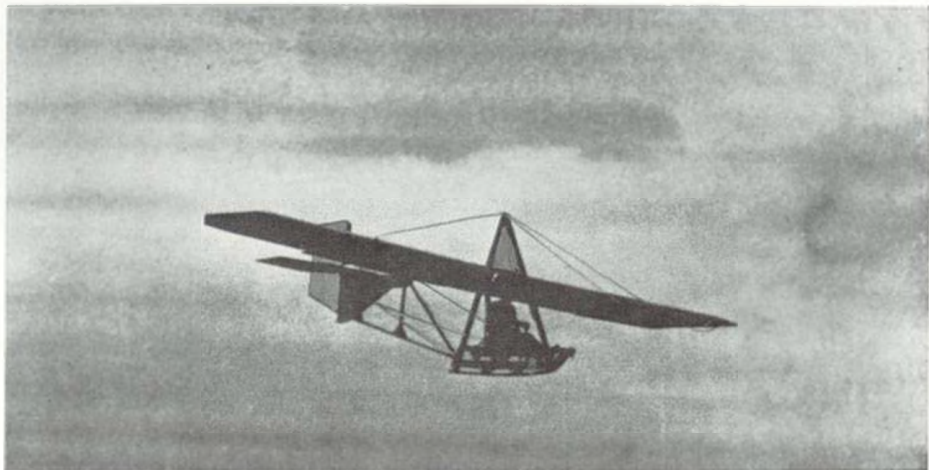

### I.C.A.R.-1 (1943)

Basic training glider

Span 10.78 m, length 5.70 m, height 2.39 m, wing area 15.40 sq m, empty weight 115 kg  
total weight 200 kg.

The *I.C.A.R.-1*,\* of which 250 were built at the *I.C.A.R.* of Bucharest, had a frame made of pine wood, reinforced with plywood struts. The constant profile wing had a rectangular form and its frame was formed of two spars. The wing tips had a curved metal tube for protection on landing. The leading edge was covered by plywood; the rest of the glider was fabric covered.

The glider had no dashboard; in the front part of the cockpit there were only the seat, the elementary controls (column and rudder pedals) and the tow rope releaser.

\* The *I.C.A.R.-1* was a modified variant of the German *Grünau-9* glider.



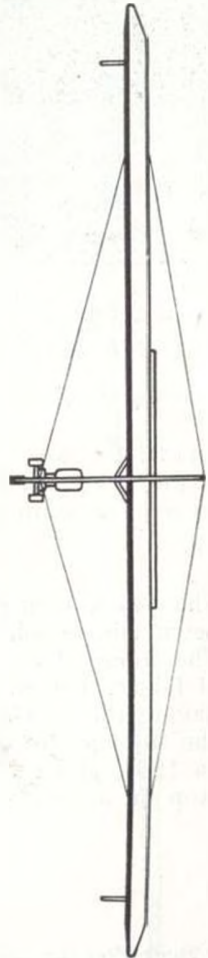
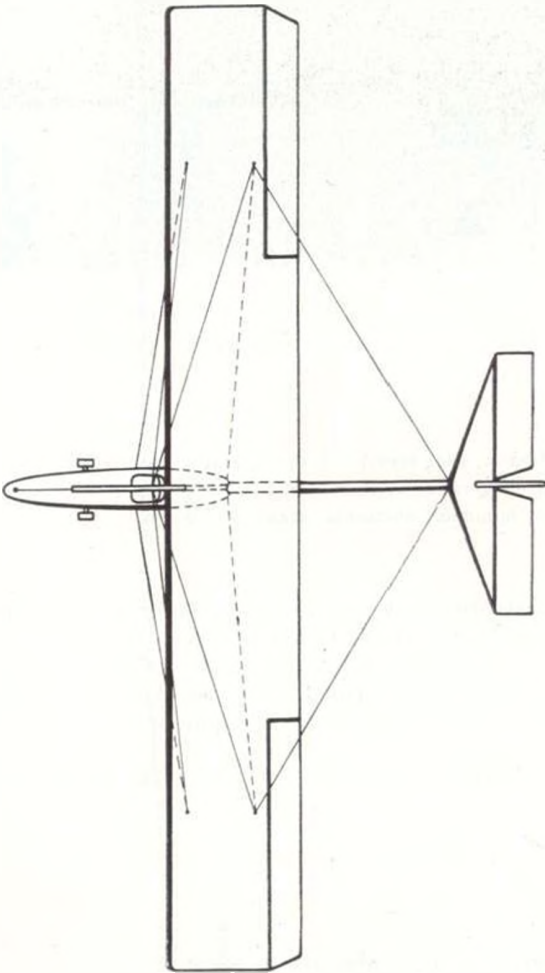
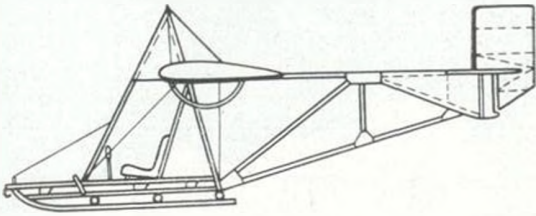

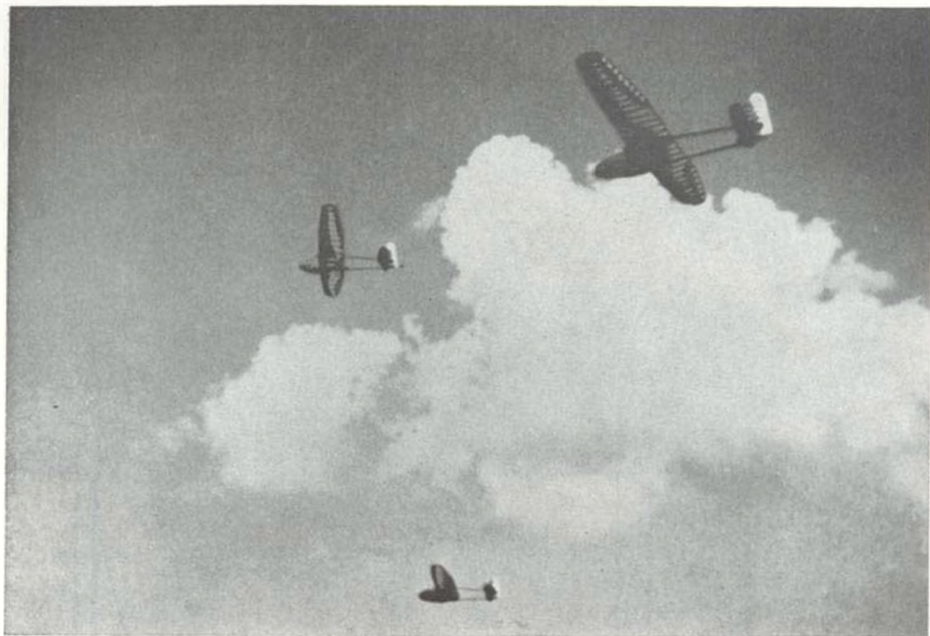

## SALAMANDRA (1943)

Training glider \*

Span 12.50 m, length 6.45 m, height 1.95 m, wing area 16.95 sq m, aspect ratio 9.20, empty weight 110 kg, total weight 195 kg, lift-drag ratio 15.00, minimum sinking speed 0.83 m/sec, maximum horizontal speed 53.3 km/h, minimum horizontal speed 38.5 km/h.

The *Salamandra* glider was mass-produced in the workshops of the Sinpetru gliding school under the guidance of the Polish Engineer *W. Kasprzyk*. The frame of the wing and tail unit was made of timber and the cover of fabric. The frame of the fuselage was formed of an uncovered gridiron, having the cockpit in front. The wings and the tail unit were linked to the fuselage by special webs.

In 1943, glider pilot *Gheorghe Brăescu* succeeded in flying 23 hours non-stop on a *Salamandra* glider.

\* Built after the design of the Polish glider of the same name.

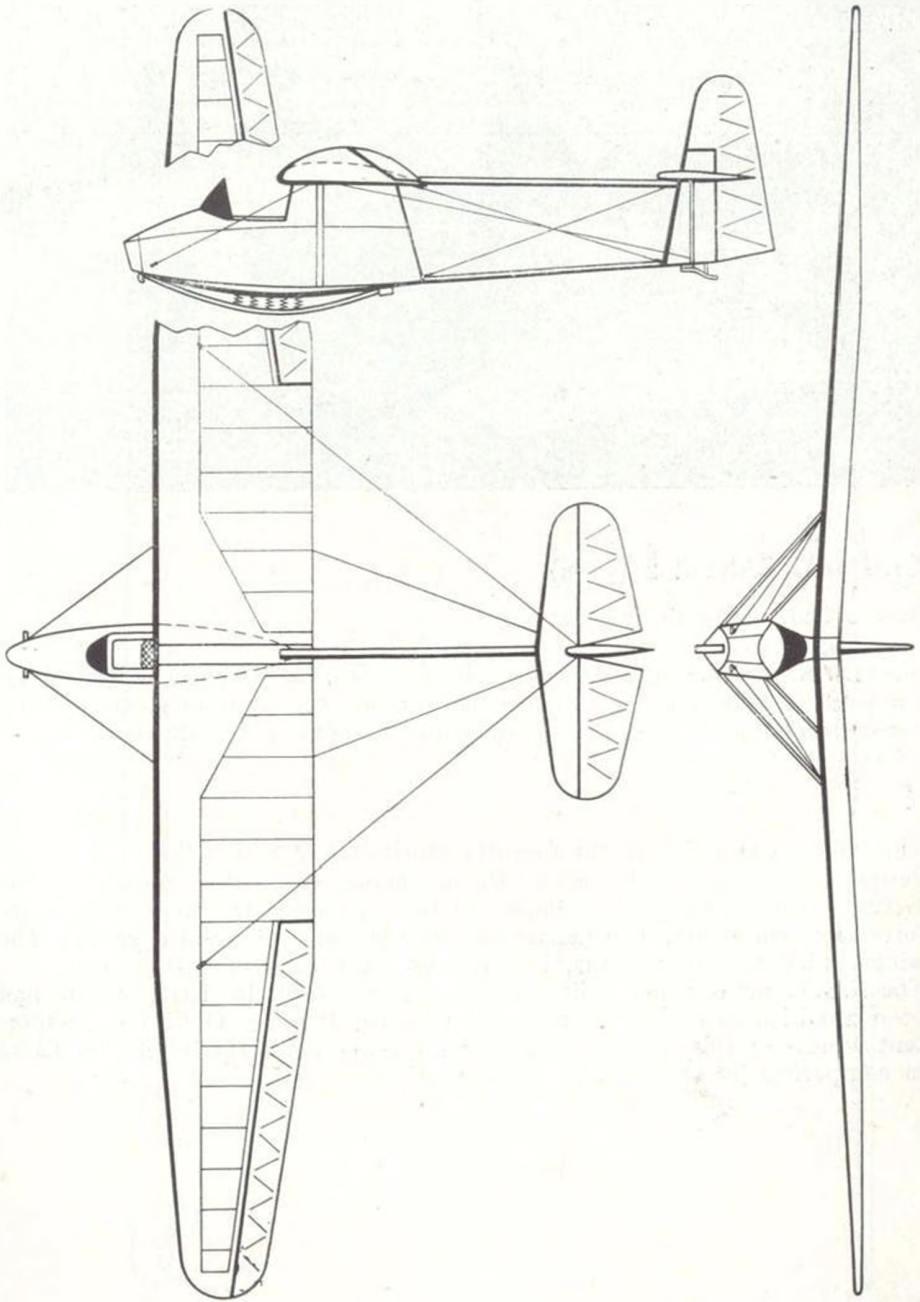



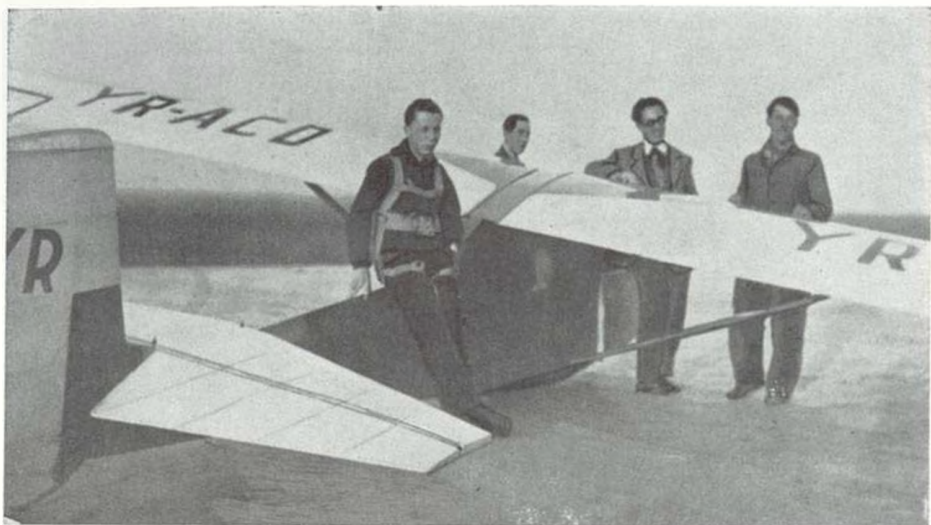

## GRÜNAU BABY-II B (1946)

Basic and advanced training glider

Span 13.57 m, length 6.09 m, height 1.38 m, wing area 14.20 sq m, empty weight 165 kg, total weight 255 kg, wing loading 16.9 kg/sq m, lift-drag ratio 17.00, maximum permitted towing speed : winch 80 km/h, aeroplane 90 km/h, maximum permitted diving speed 200 km/h, minimum sinking speed 0.87 m/sec.

This glider was built by the aircraft factories *S.E.T.* and *I.C.A.R.* after the design of Engineer *Alexandru Marcu*, being a modified variant of the German *Grünau Baby-II B* glider. It was a one-seater high wing reinforced by two struts. The hexagonal fuselage had a plywood covering. The wings, with a timber frame, had *Schepp-Hirth* aerodynamic brakes. The *S.E.T.* factory had built a *Grünau Baby-II A* in 1934, which had been modified in certain respects by *Valentin Popescu*. One of the important results of this improvement was the reduction of the weight by 12 kg in comparison to the original German glider.

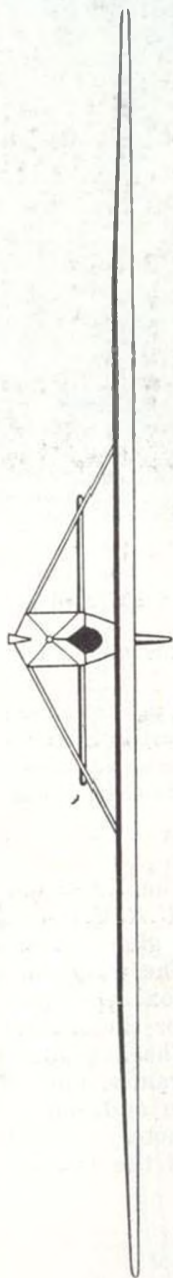
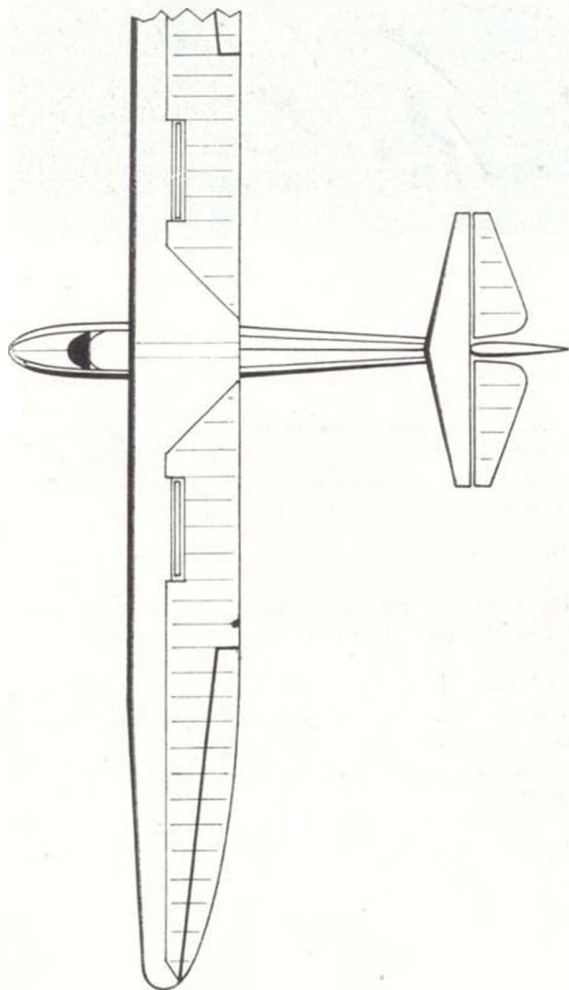
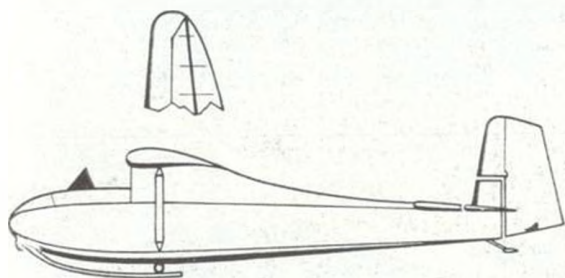

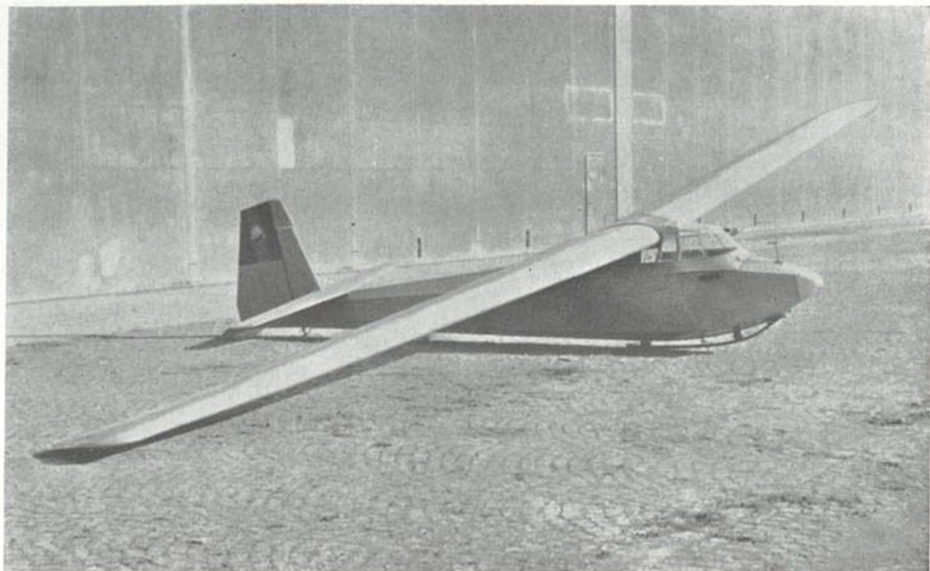

## I.S.-2 (1949)

### Advanced training glider

Span 12.30 m, length 6.54 m, height 1.56 m, wing area 14.70 sq m, empty weight 160 kg, total weight 250 kg, wing loading 17.00 kg/sq m, maximum lift-drag ratio 20.00, maximum permitted speed 180 km/h, maximum admitted towing speed: winch 80 km/h, aeroplane 110 km/h, minimum horizontal speed 42 km/h, minimum sinking speed 0.77 m/sec.

The *I.S.-2* one-seater, built by the *Uzinele de reparații material volant (U.R.M.V.-3)* of Brașov after the design of Engineer *Iosif Șilimon*, was a glider of mixed construction.

The wing, having differential ailerons, had the frame formed of a principal box type spar and a false (torsion) spar and was covered by fabric, except for the leading edge, which had a plywood covering.

The hexagonal fuselage was made of longitudinal stringers and transversal frames, and was covered by plywood.

In addition to the instruments (turn and bank indicator, speedometer, altimeter, and rate of climb indicator), the dashboard also had the releaser of the towing rope.



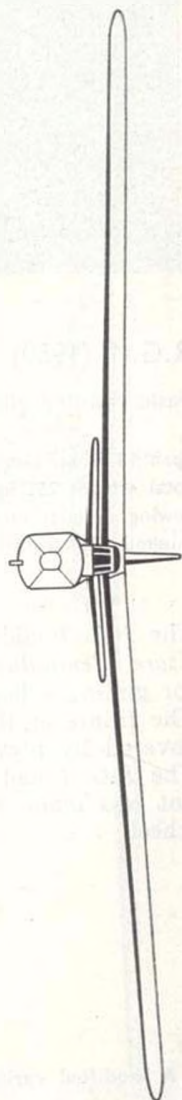
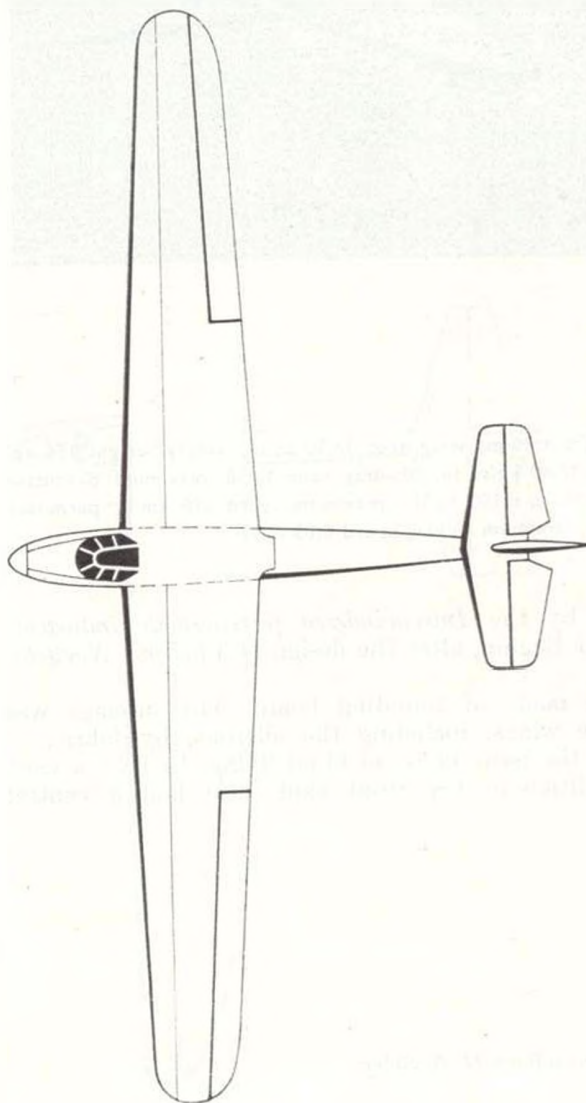
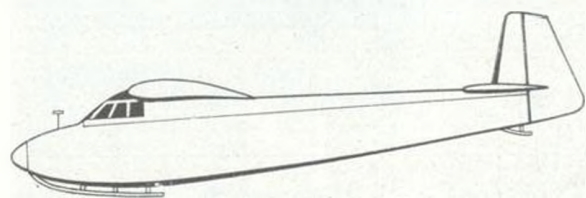

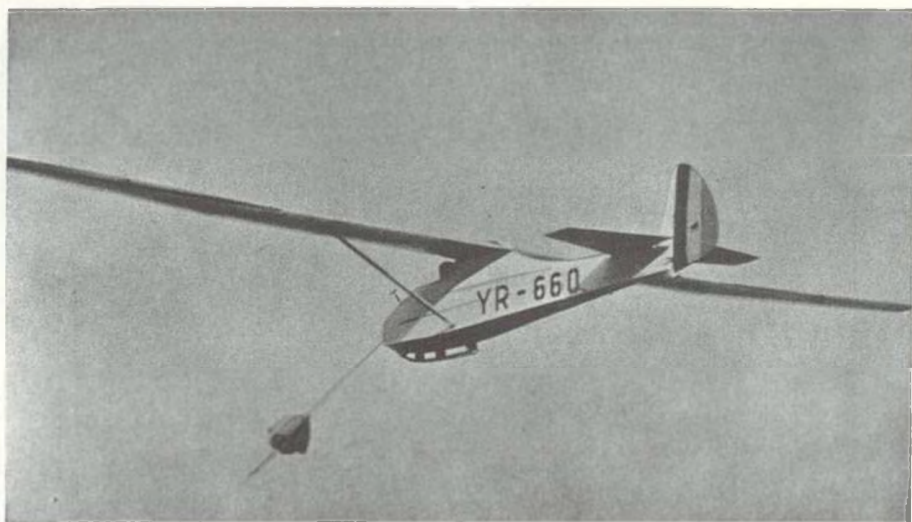

### R.G.-1 (1950)

Basic training glider \*

Span 13.50 m, length 6.19 m, height 1.40 m, wing area 14.20 sq m, empty weight 156 kg, total weight 251 kg, wing loading 17.60 kg/sq m, lift-drag ratio 18.50, maximum permitted towing speed: winch 85 km/h, aeroplane 100 km/h, maximum speed 210 km/h, permitted minimum horizontal speed 50 km/h, minimum sinking speed 0.85 m/sec.

The *R.G.-1* glider was built by the *Întreprinderea forestieră de industrializare a lemnului (I.F.I.L.)* of Reghin, after the design of *Vladimir Novîchi*, for gliding schools.

The frame of the glider was made of sounding board. The fuselage was covered by plywood and the wings, including the ailerons, by fabric. The *R.G.-1* had controls for the basic phase of blind flying. In 1953 a variant was made which, in addition to the front skid, also had a central wheel.

\* A modified variant of the *Grünau-Baby-II B* glider.

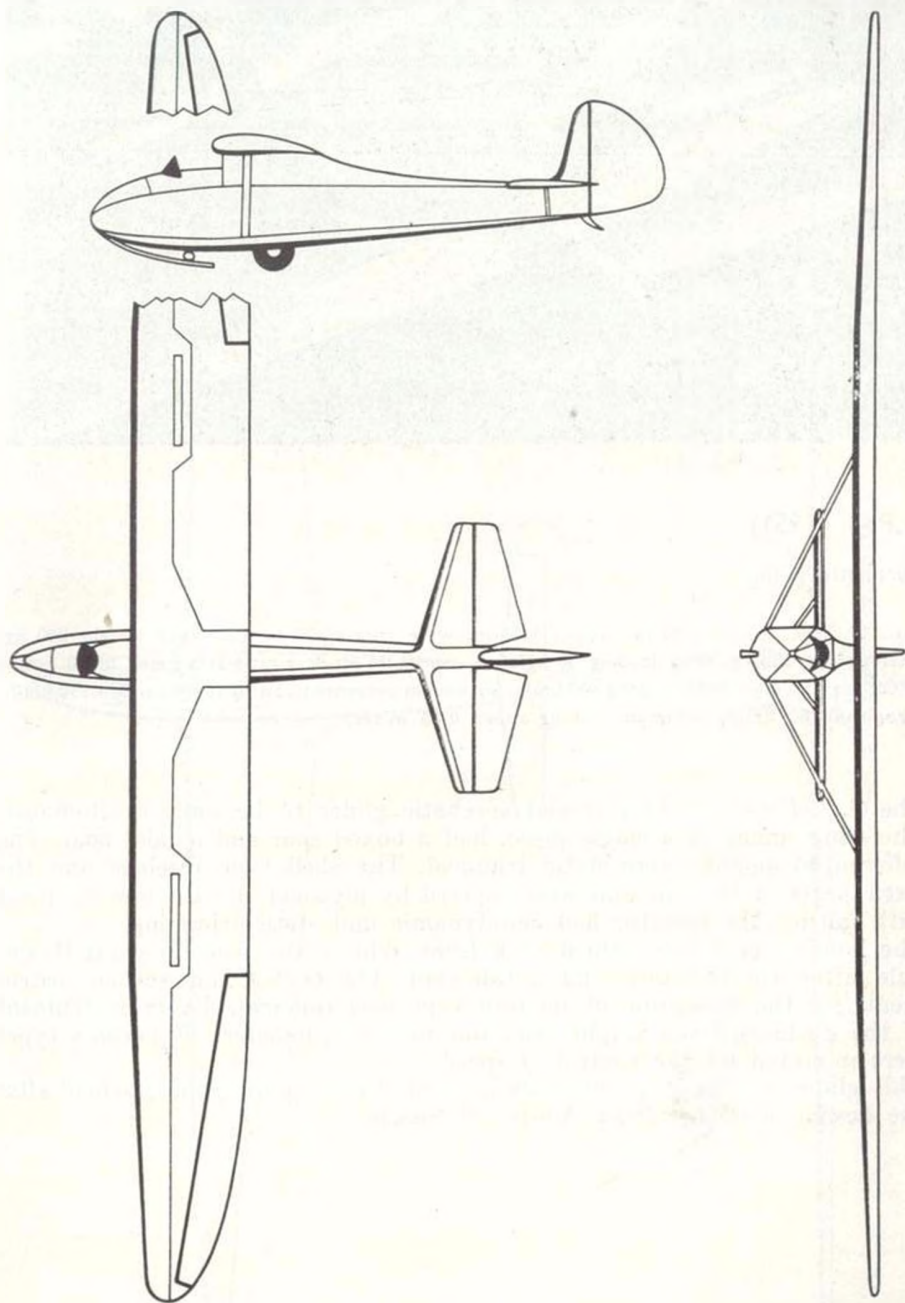



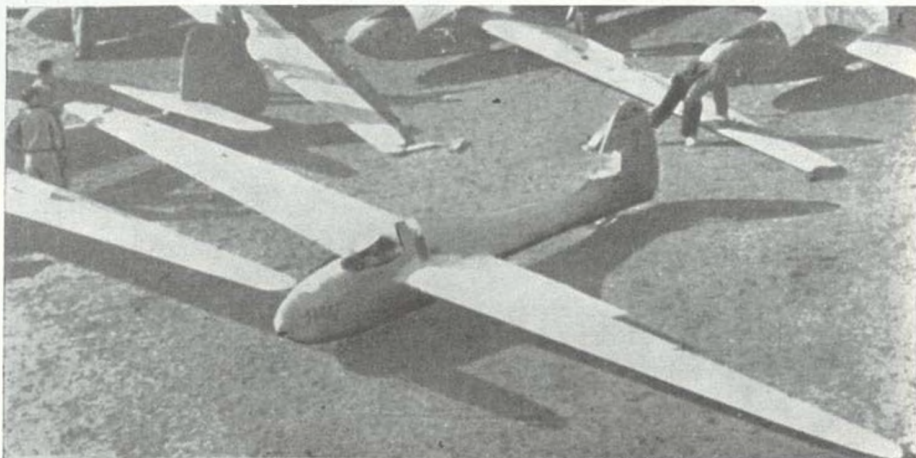

## O.P.-1 (1951)

### Aerobatic glider

Span 11.78 m, length 5.60 m, height 1.50 m, wing area 10.70 sq m, empty weight 240 kg, total weight 320 kg, wing loading 30 kg/sq m, optimum lift-drag ratio at a speed of 80 km/h : 25.00, maximum permitted speed 400 km/h, maximum permitted towing speed : winch 130 km/h, aeroplane 180 km/h, minimum sinking speed 0.85 m/sec.

The *O.P.-1* was the first special aerobatic glider to be built in Romania. The wing, made of a single piece, had a boxed spar and a false spar. The differential ailerons were static trimmed. The shell type fuselage and the fixed parts of the tail unit were covered by plywood and the moving parts with fabric. The elevator had aerodynamic and static trimming.

The landing gear was formed of a front skid, a two wheel bogie (jettisonable after the take-off), and a tail skid. The *O.P.-1* had special instruments for the measuring of its prototype performances. Every instrument of the dashboard was duplicated, and four speedometers of various types were mounted for the control of speed.

This glider was built in the workshops of the Sinpetru gliding school after the design of *Ovidiu Popa*, Master of Sports.

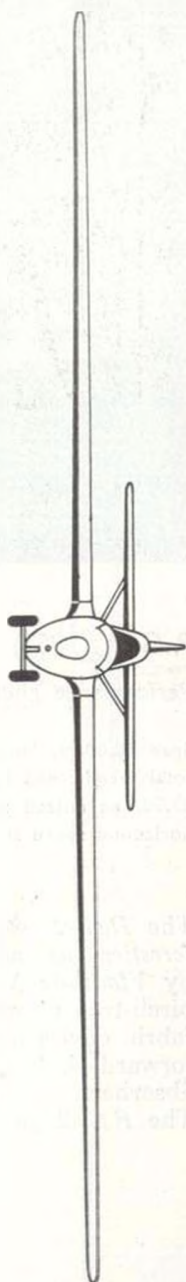
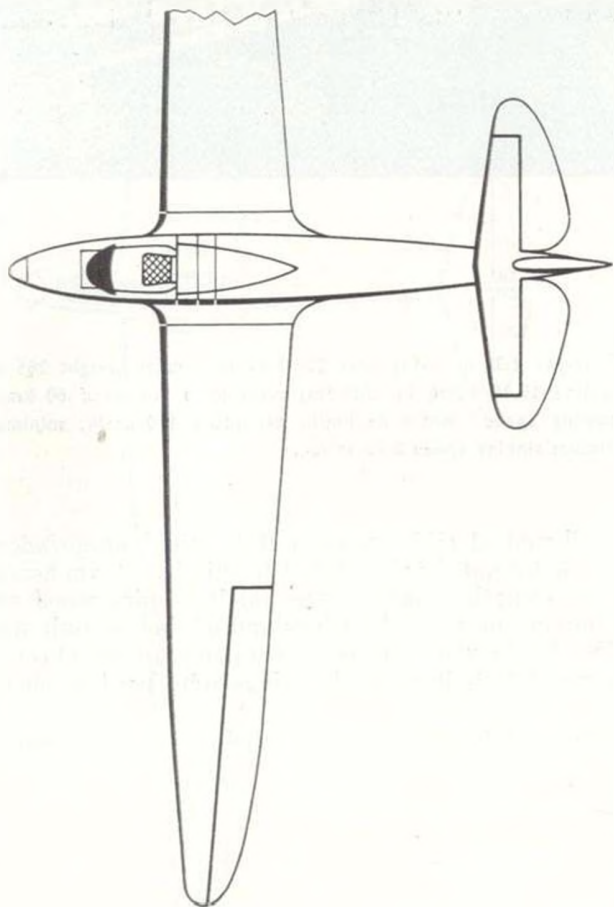
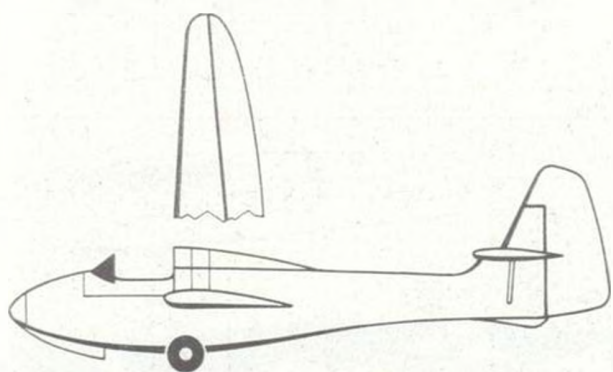

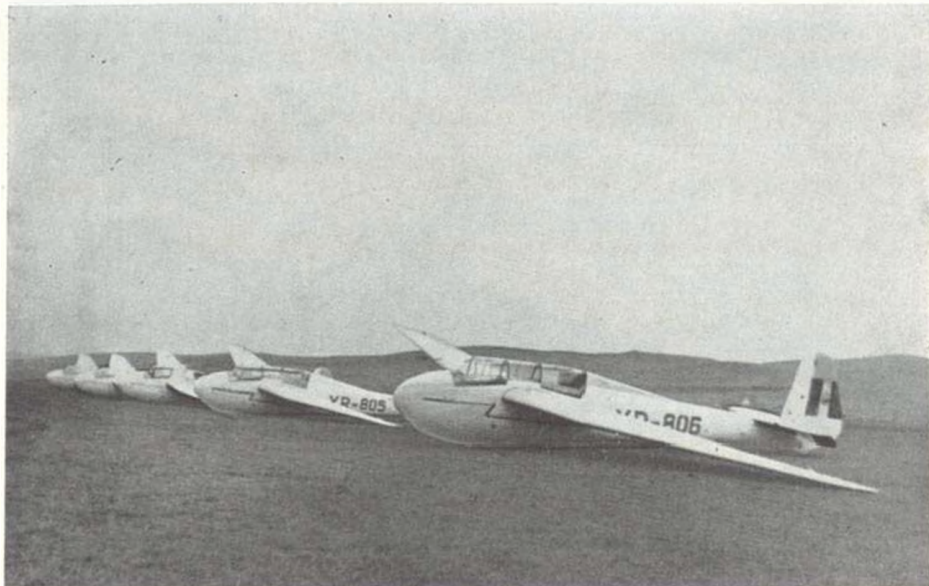

## R.G.-2 (1952)

Performance glider \*

Span 18.00 m, length 8.01 m, height 2.30 m, wing area 22.07 sq m, empty weight 285 kg, total weight 465 kg, wing loading 19.10 kg/sq m, lift-drag ratio at a speed of 60 km/h: 23.50, permitted maximum towing speed: winch 85 km/h, aeroplane 110 km/h, minimum horizontal speed 50 km/h, minimum sinking speed 0.70 m/sec.

The *R.G.-2* two-seater dual-control glider was built by the *Întreprinderea forestieră de industrializare a lemnului (I.F.I.L.)* of Reghin by a team headed by *Vladimir Novîţchi*. The strength elements were made of pine wood and birch-tree plywood. The moving parts of the wings and of the tail unit were fabric covered. The undercarriage was formed of two balloon tyre wheels, a forward skid and an ash wood tail skid. Rubber rings were used as shock-absorbers.

The *R.G.-2* glider was also used for towed flight dual-control training.

\* A modified variant of the *D.F.S.-Kranich* glider.



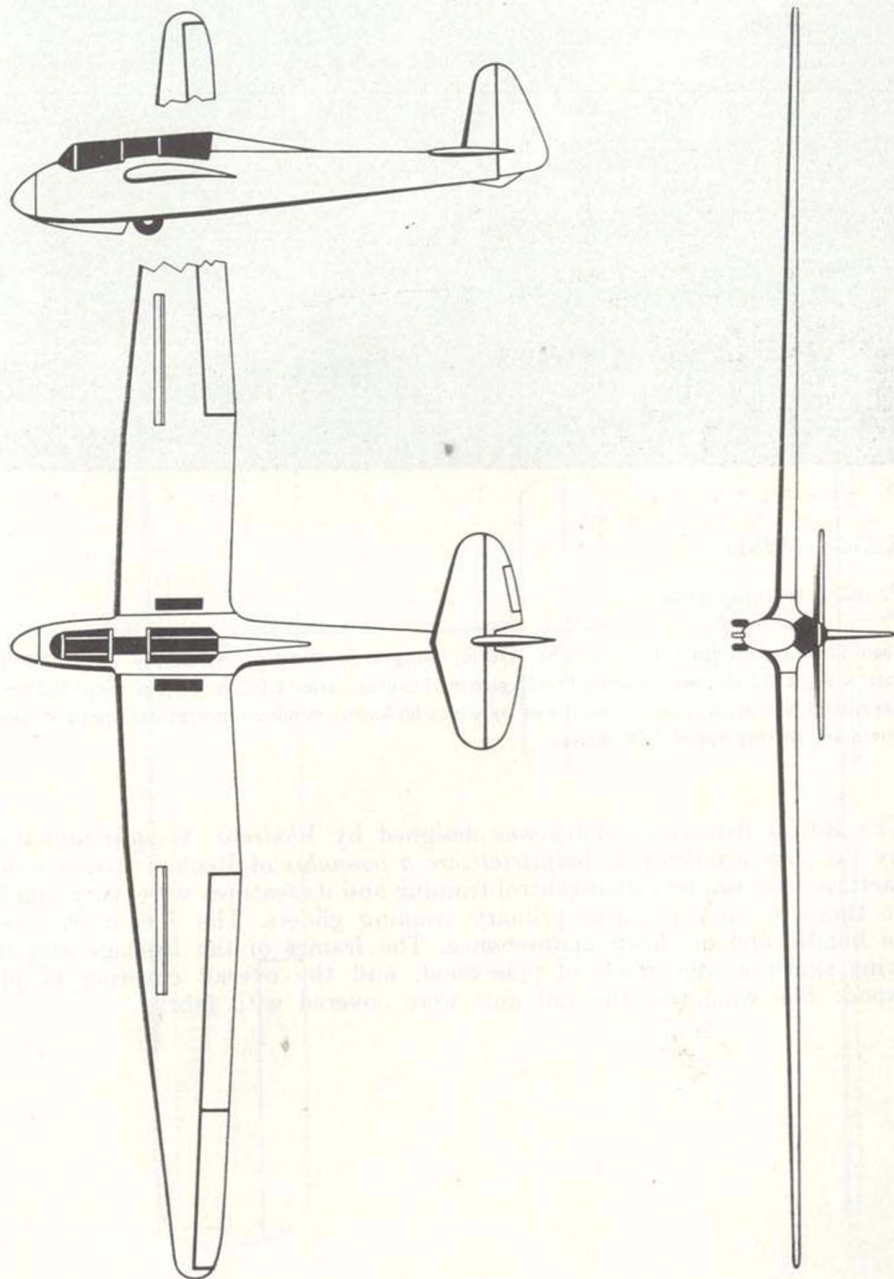

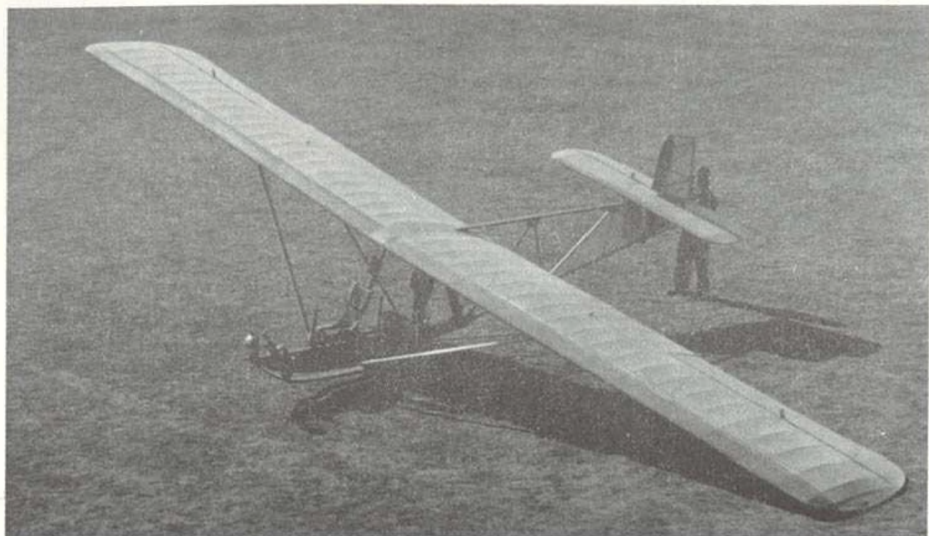

### R.G.-3 (1953)

Primary training glider

Span 12.60 m, length 6.80 m, height 1.70 m, wing area 19.90 sq m, empty weight 150 kg, total weight 310 kg, wing loading 14.40 kg/sq m, lift-drag ratio 16.00, maximum speed 165 km/h, permitted maximum speed when towed by winch 80 km/h, minimum horizontal speed 44 km/h, minimum sinking speed 1.00 m/sec.

The *R.G.-3* two-seater glider was designed by *Vladimir Novitchi* and built by the *Întreprinderea de industrializare a lemnului* of Reghin. It was manufactured for primary dual-control training and its features were very similar to those of the one-seater primary training gliders. The *R.G.-3* was easy to handle and of cheap maintenance. The frames of the fuselage and the wing skeleton were made of pine-wood, and the overall covering of plywood. The wing and the tail unit were covered with fabric.

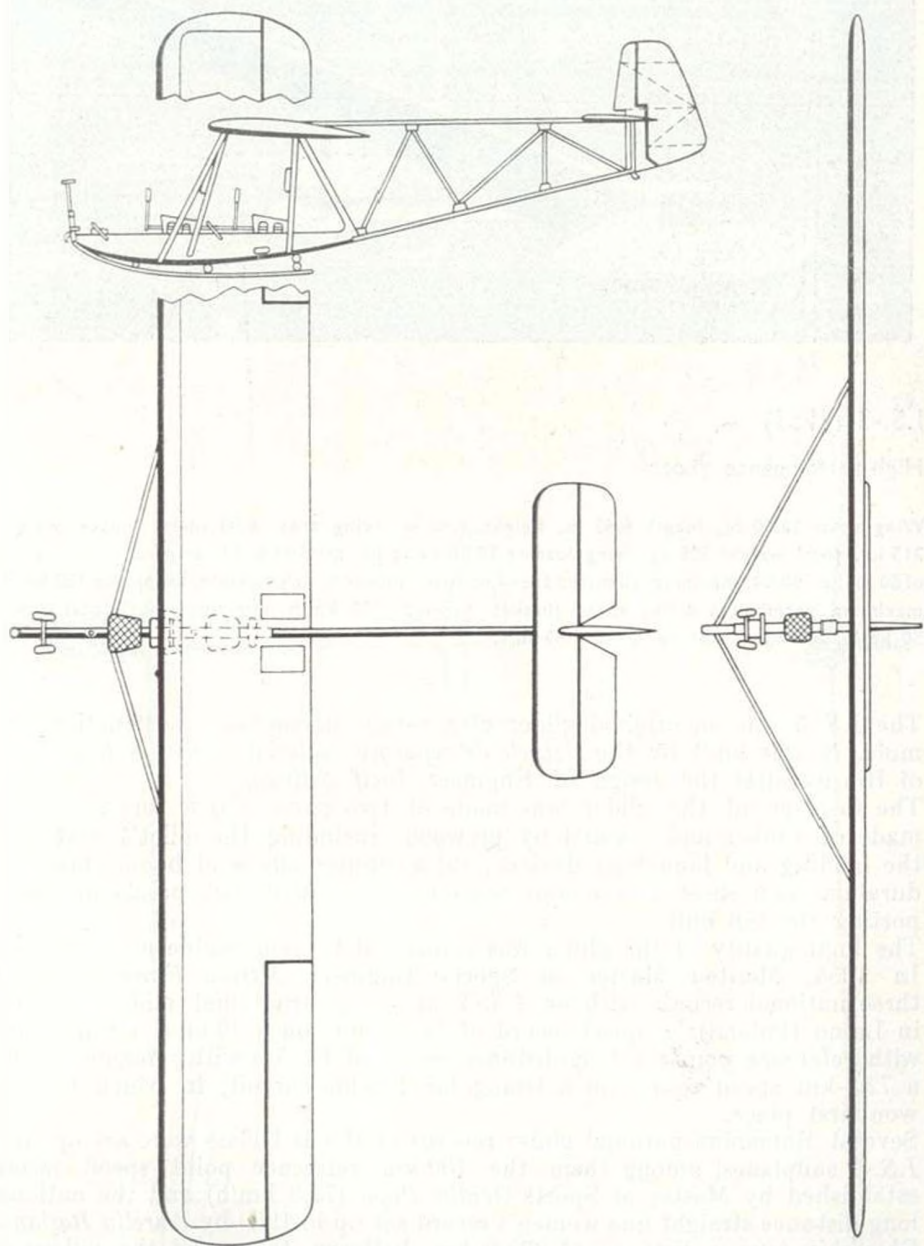



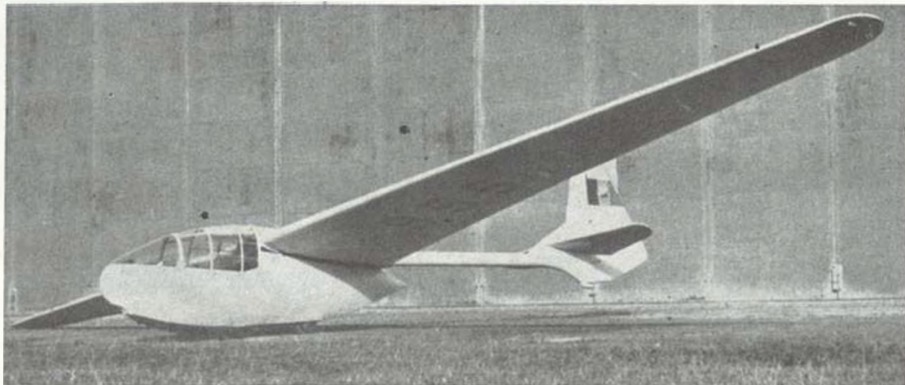

### I.S.-3 (1953)

High-performance glider

Wing span 16.00 m, length 6.45 m, height 1.43 m, wing area 16.00 sq m, empty weight 215 kg, total weight 305 kg, wing loading 19.10 kg/sq m, maximum lift-drag ratio at a speed of 80 km/h : 30.00, maximum admitted speed on tow : motor winch 90 km/h, aeroplane 120 km/h, maximum permissible diving speed (brakes opened) 200 km/h, minimum horizontal speed 50 km/h, minimum sinking speed 0.65 m/s.

The *I.S.-3* was an original glider of a rather uncommon construction formula. It was built by the *Uzinele de reparații material volant (U.R.M.V.-3)* of Brașov after the design of Engineer *Iosif Șilimon*.

The fuselage of the glider was made of two parts: (a) a forward shell, made of timber and covered by plywood, including the pilot's seat and the landing and launching devices; (b) a tubular all-metal boom (made of duraluminium sheet of 1.5 mm) fixed to the shell in two points and supporting the tail unit.

The high quality of the glider was confirmed by remarkable performances. In 1954, Merited Master of Sports Engineer *Mircea Finescu* set up three national records with an *I.S.-3* at an international gliding contest in Lesno (Poland): a speed record of 74.5 km/h on a 300-km straight line with reference point; a long-distance record of 305-km with reference point; a 72.3-km speed record on a triangular 100-km circuit, in which he also won first place.

Several Romanian national glider records of the D-1 class were set up with *I.S.-3* sailplanes, among them the 100 km reference point speed record established by Master of Sports *Ovidiu Popa* (72.3 km/h) and the national long-distance straight line women's record set up in 1963 by *Aurelia Roșianu-Gheorghiu* over a distance of 325.6 km, between Jassy and the village of Cuza Vodă.

INTERPRIND: REA CONSTRUCTII AERONAUTICE  
BIBLIOTECA  
NR. ....  
TEHNICA  
- BRASOV -

I. S.-3

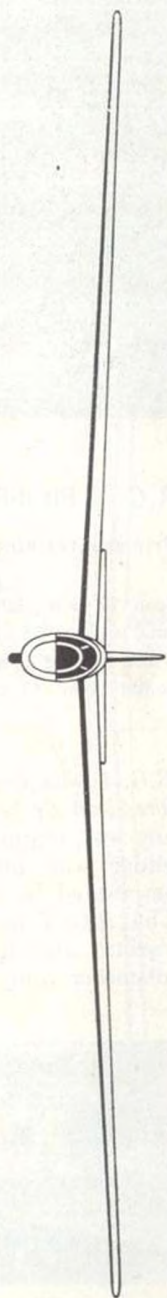
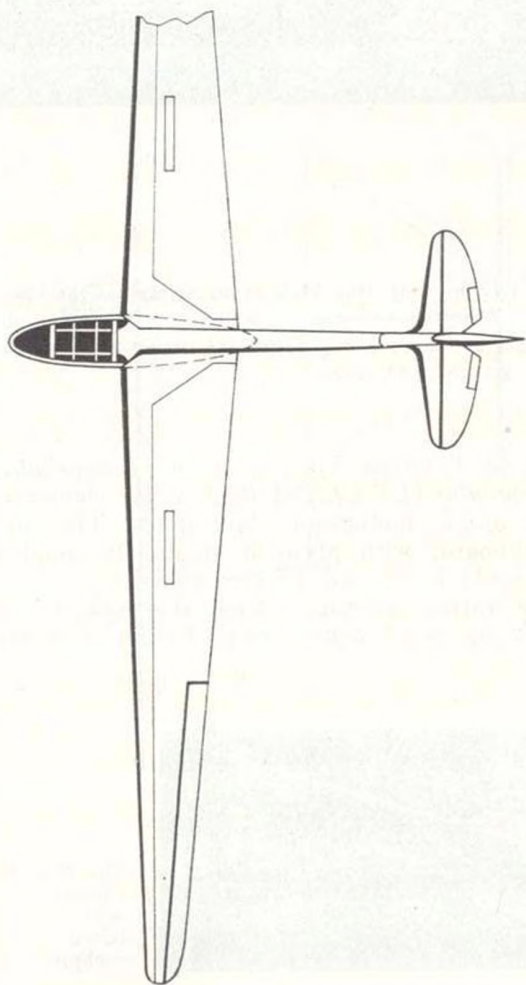
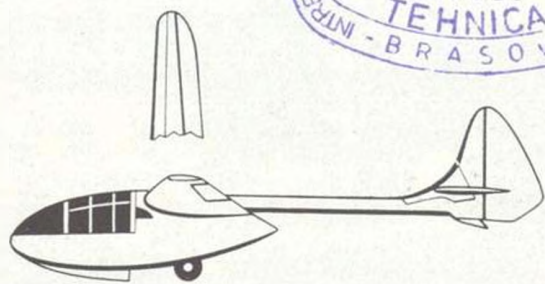



### R.G.-4 PIONIER (1954)

Primary training glider

Span 10.45 m, length 5.75 m, height 1.20 m, wing area 14.80 sq m, empty weight 100 kg, total weight 188 kg, load wing loading 12.70 kg/sq m, lift-drag ratio 14.50, maximum permitted winch towing speed 90 km/h, maximum permitted diving speed 165 km/h, minimum horizontal speed 40 km/h, minimum sinking speed 0.90 m/sec.

*R.G.-4* was designed and built by *Vladimir Novitchi* at the *Întreprinderea forestieră de industrializare a lemnului (I.F.I.L.)* of *Reghin*, for elementary one-seat training and for slope and/or motorwinch launchings. The entire glider was built of sounding board, with plywood struts. It could be assembled in 20 minutes and could be carried by two persons.

The *R.G.-4* was also built in a variant having a removable cockpit. This variant also had elementary flying instruments: rate of climb indicator, altimeter and speedometer.



The *R.G.-4* variant with faired cockpit.



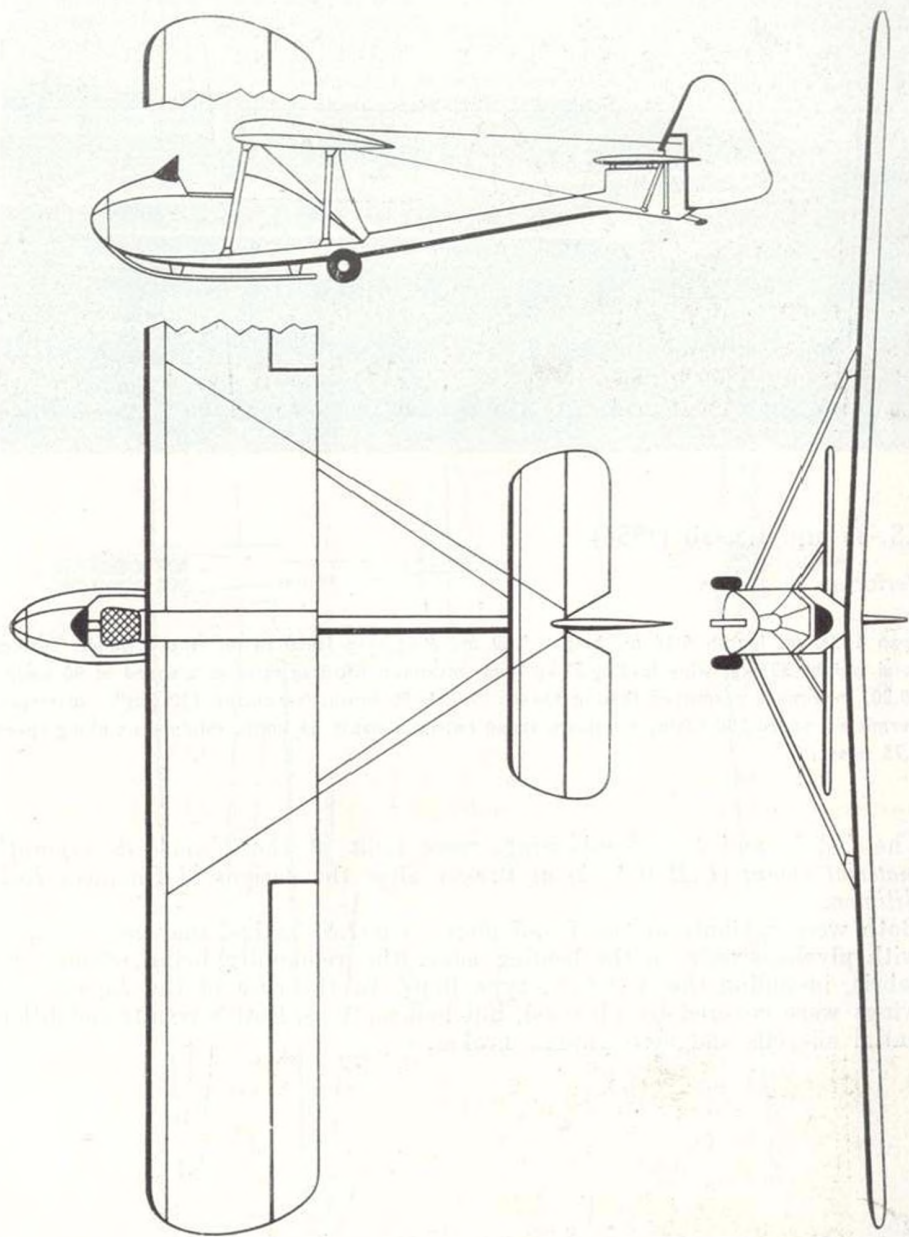

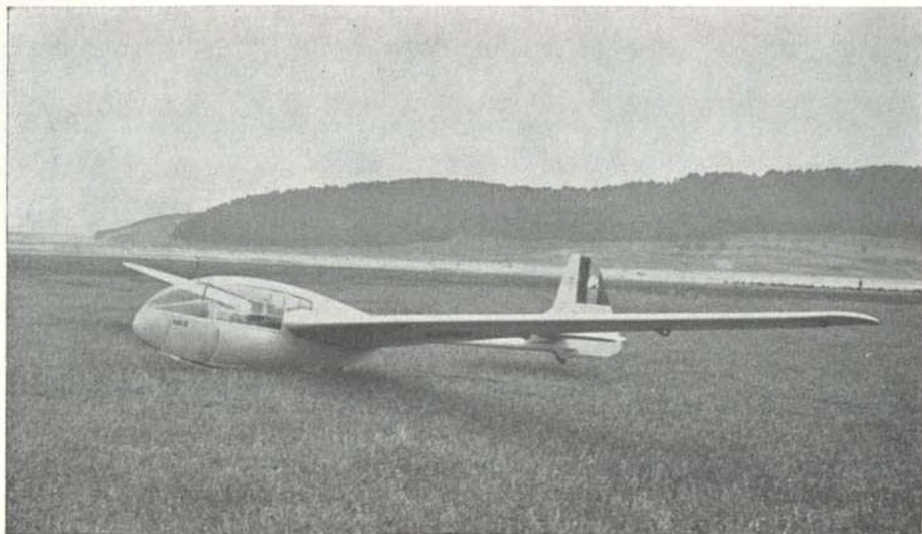

### I.S.-3a and I.S.-3b (1954)

#### Performance gliders

Span 16.00 m, length 6.66 m, height 1.60 m, wing area 16.00 sq m, empty weight 245 kg, total weight 335 kg, wing loading 21 kg/sq m, maximum lift-drag ratio at a speed of 90 km/h: 28.20, maximum permitted towing speed: winch 90 km/h, aeroplane 120 km/h, maximum permitted speed 180 km/h, minimum speed (without flaps) 65 km/h, minimum sinking speed 0.75 m/sec.

The *I.S.-3a* and *I.S.-3b* mid-wings were built at the *Uzinele de reparații material volant (U.R.M.V.-3)* of Brașov after the designs of Engineer *Iosif Șilimon*.

Both were variants of the *I.S.-3* glider. The *I.S.-3a* had the wings covered with plywood only on the leading edge, the remainder being covered by fabric, including the *N.A.C.A.* type flaps. In the case of the *I.S.-3b*, the wings were covered by plywood, but had no flaps. Both variants had differential ailerons and aerodynamic brakes.

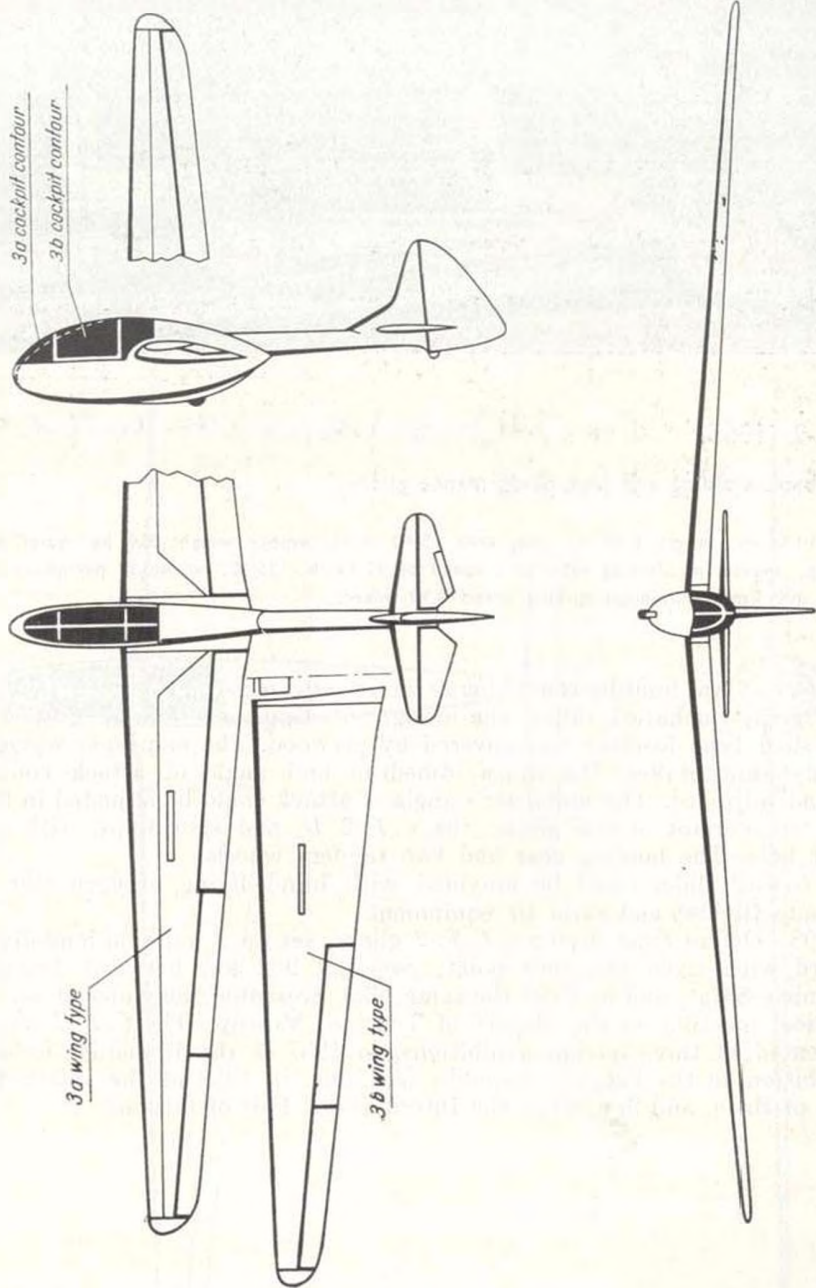



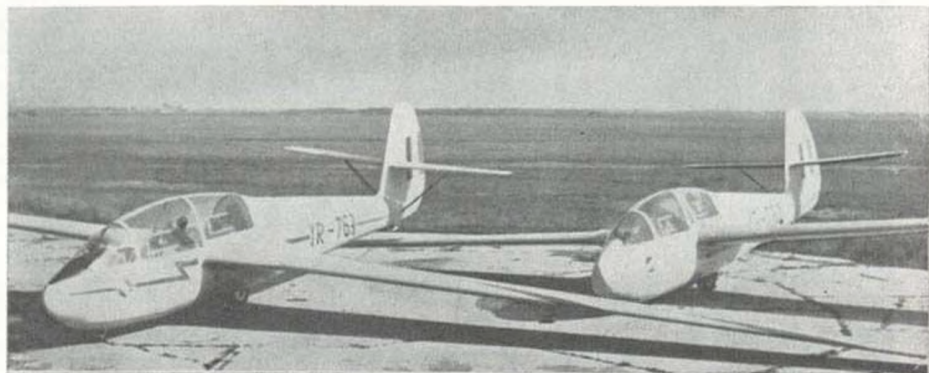

### C.T.-2 (1955)

Aerobatic training and high-performance glider

Span 14.60 m, length 8.00 m, wing area 15.40 sq m, empty weight 350 kg, total weight 540 kg, maximum lift-drag ratio at a speed of 95 km/h: 25.00, maximum permitted diving speed 300 km/h, minimum sinking speed 0.90 m/sec.

The *C.T.-2* was built by the *Atelierele de reparații material volant (A.R.M.V-2)* of Pipera, Bucharest, after the design of Engineer *Traian Costăchescu*. The shell type fuselage was covered by plywood. The monospar wings had aerodynamic brakes. The wings' dihedral and angle of attack could be ground adjusted. The stabilizer's angle of attack could be adjusted in flight. The last variant of this glider, the *C.T.-2 B*, had split flaps, with a circular hole. The landing gear had two tandem wheels.

The *C.T.-2* glider could be provided with blind flying, oxygen (for high altitude flights) and radio t/r equipment.

In 1957 *Ovidiu Popa*, flying a *C.T.-2* glider, set up a national long-distance record with fixed reference point, covering 202 km between Jassy and Rimnicu Sărat, and in 1958 the same pilot presented the glider at an aeronautical meeting on the airport of Tushino, Moscow. The *C.T.-2* was also presented at three foreign exhibitions, in 1957 at the Romanian industrial exhibition in the People's Republic of China, in 1959 at the International Fair of Brno, and in 1960 at the International Fair of Poznan.

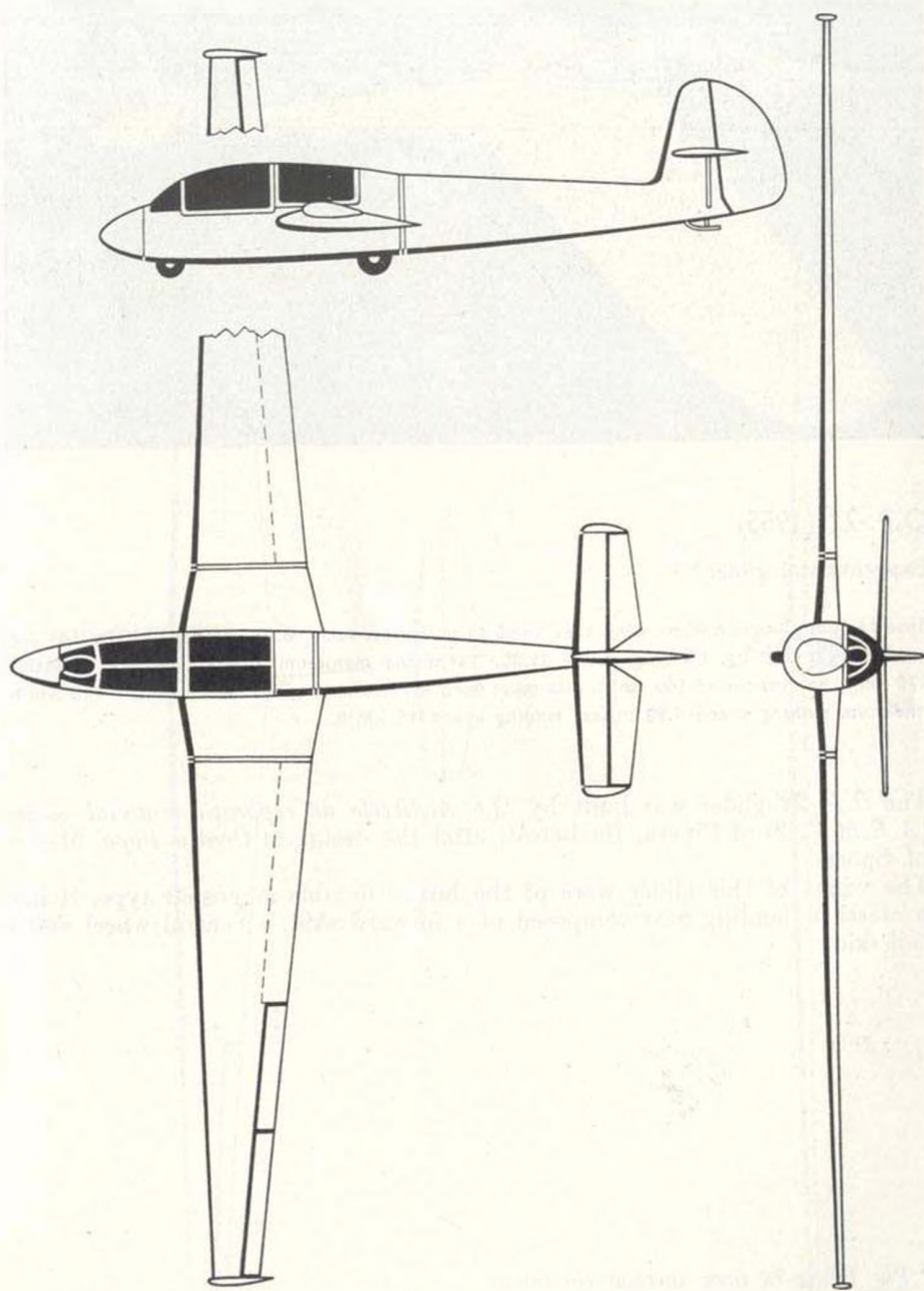



### O.P.-22 (1955)

Experimental glider \*

Span 16.00 m, length 6.00 m, wing area 14.00 sq m, aspect ratio 18.03, empty weight 165 kg, total weight 255 kg, lift-drag ratio 31.00, permitted maximum speed: in quiet weather 170 km/h, in gusty wind 140 km/h, maximum permitted towing speed by aeroplane 110 km/h, minimum sinking speed 0.90 m/sec, landing speed 45 km/h.

The *O.P.-22* glider was built by the *Atelierele de reparatii material volant (A.R.M.V.-2)* of Pipera, Bucharest, after the design of *Ovidiu Popa*, Master of Sports.

The wings of this glider were of the boxed flexible monospar type. It had a classical landing gear composed of a forward skid, a central wheel and a tail-skid.

\* For flying in poor thermal conditions.



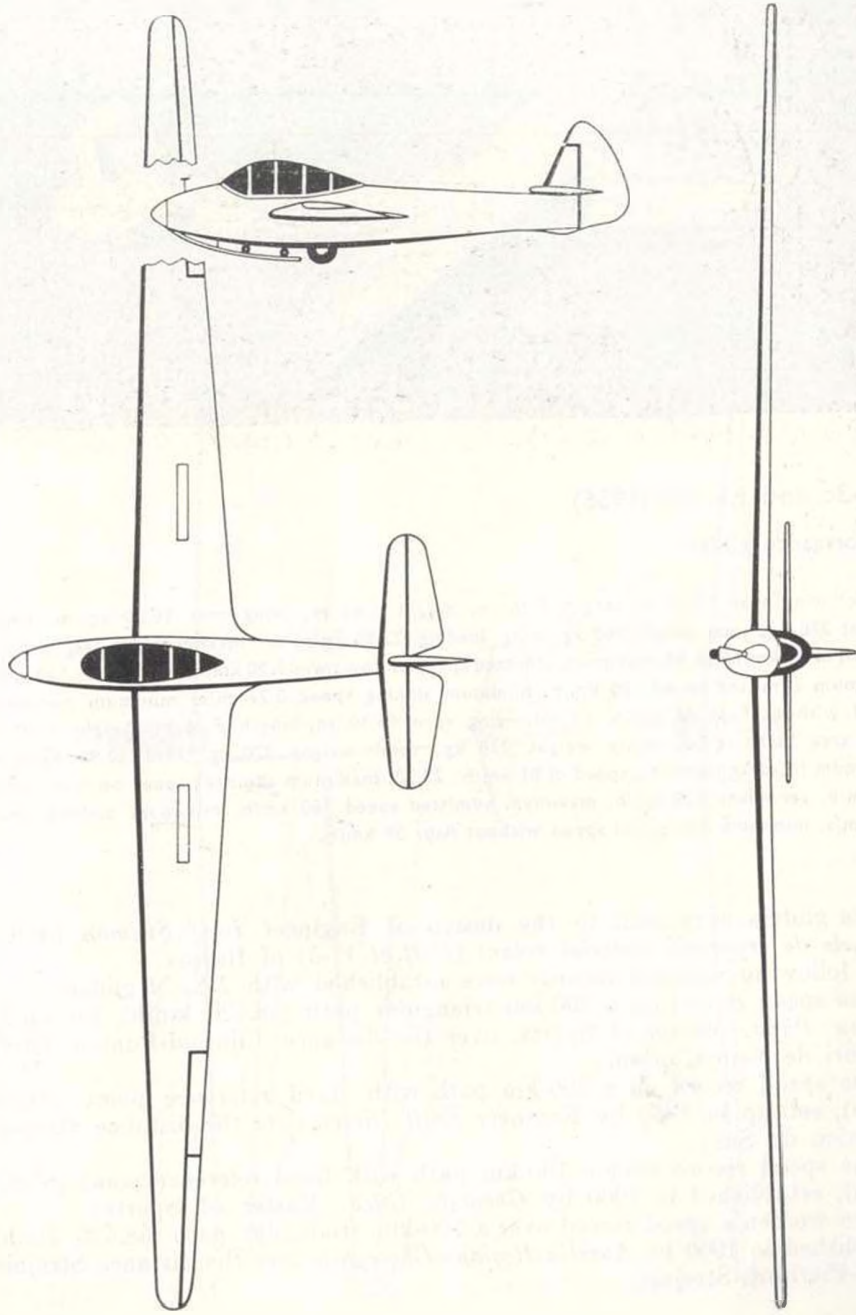



### I.S.-3c and I.S.-3d (1956)

#### Performance gliders

*I.S.-3c*: wing span 17.00 m, length 7.26 m, height 1.60 m, wing area 16.00 sq m, empty weight 270 kg, total weight 360 kg, wing loading 22.50 kg/sq m, maximum lift-drag ratio at a speed of 81 km/h : 26.90, maximum admitted speed on tow : winch 90 km/h, aeroplane 120 km/h, maximum admitted speed 180 km/h, minimum sinking speed 0.77 m/s, minimum horizontal speed without flaps 61 km/h. *I.S.-3d*: wing span 15.30 m, length 7.26 m, height 1.60 m, wing area 15.30 sq m, empty weight 230 kg, total weight 320 kg, load 20.90 kg/sq m, maximum lift-drag ratio at a speed of 81 km/h : 25.30, maximum admitted speed on tow : winch 90 km/h, aeroplane 120 km/h, maximum admitted speed 180 km/h, minimum sinking speed 0.77 m/s, minimum horizontal speed without flaps 59 km/h.

These gliders were built to the design of Engineer *Iosif Şilimon* by the *Uzinele de reparații material volant (U.R.M.V.-3)* of Braşov.

The following national records were established with *I.S.-3d* gliders:

- the speed record on a 200-km triangular path (48.420 km/h), set up by *Ovidiu Popa*, Master of Sports, over the distance Clinceni-Puntea Greci-Roşiori de Vede-Clinceni;
- the speed record on a 200-km path with fixed reference point (59.040 km/h), set up in 1960 by Engineer *Emil Iliescu* over the distance Strejnic-Rimnicu de Sus;
- the speed record over a 100 km path with fixed reference point (83.820 km/h), established in 1960 by *Gheorghe Gilcă*, Master of Sports;
- the women's speed record over a 100-km triangular path (48.425 km/h), established in 1960 by *Aurelia Roşianu-Gheorghiu* over the distance Strejnic-Mizil-Fierbinţi-Strejnic.

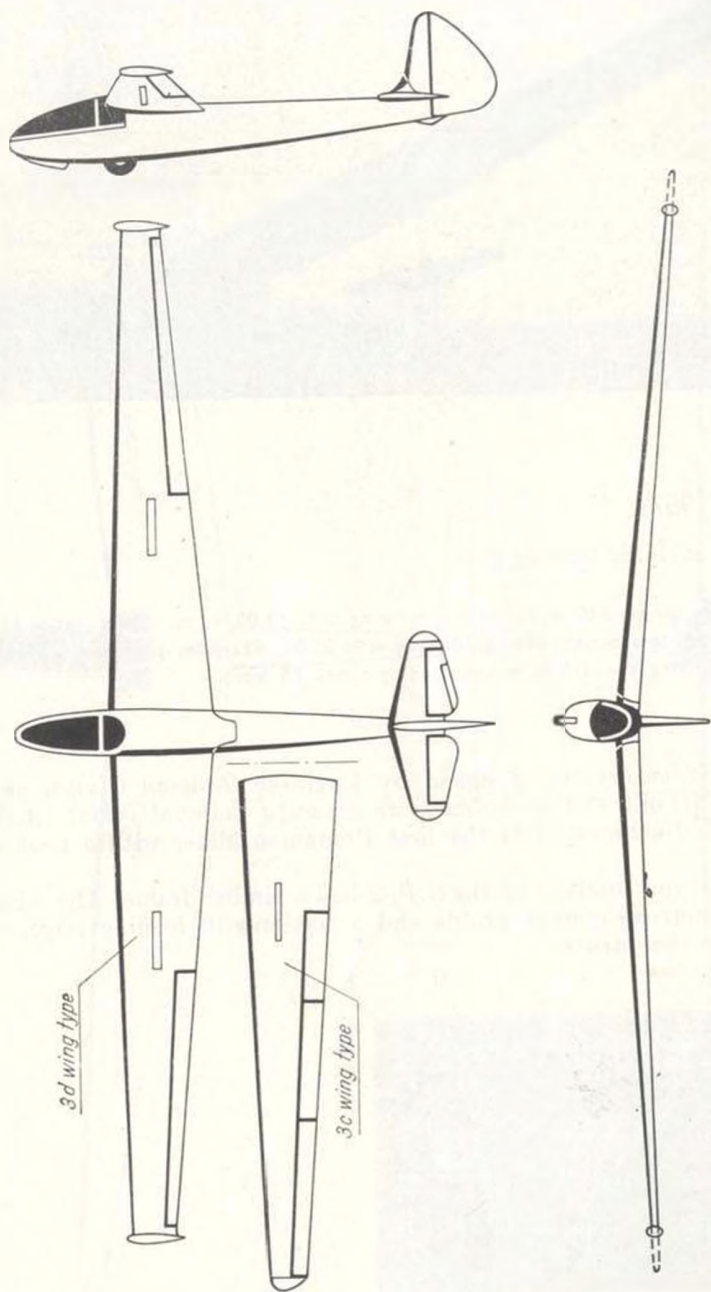





### G.P.-2 (1957)

Basic and advanced training glider

Span 16.00 m, length 8.00 m, height 2.20 m, wing area 18.00 sq m, aspect ratio 14.22, empty weight 330 kg, total weight 510 kg, lift-drag ratio 25.00, maximum permitted speed 220 km/h, minimum sinking speed 0.80 m/sec, landing speed 65 km/h.

The *G.P.-2* two-seater, designed by Engineer *Octavian Giuncu* and *Ovidiu Popa*, and built at the *Atelierele de reparații material volant (A.R.M.V.-2)* of Pipera, Bucharest, was the first Romanian glider with a negative boom wing.

The shell type fuselage of the *G.P.-2* had a timber frame. The wing, having an asymmetrical convex profile and a torsion-stiff leading edge, was reinforced by two struts.



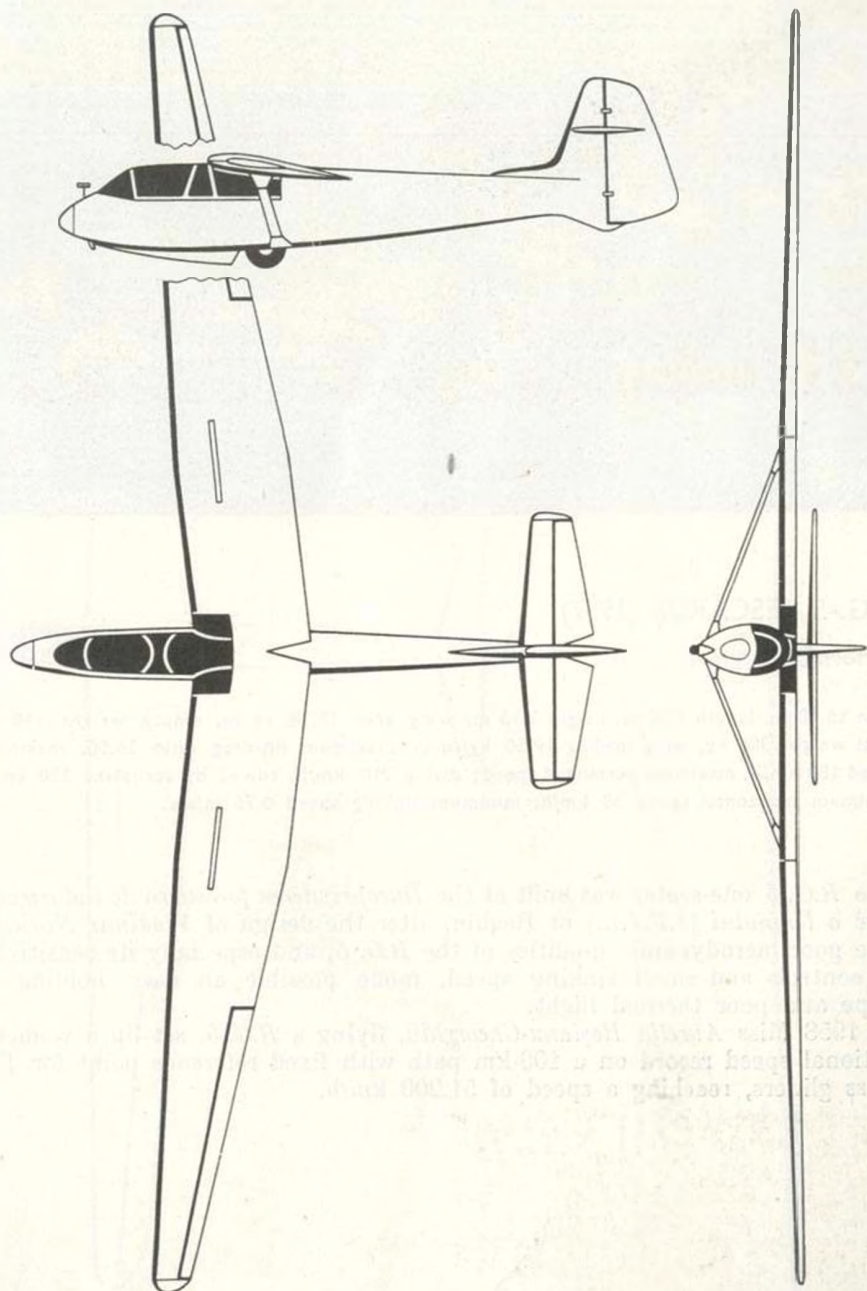



### R.G.-5 PESCĂRUȘ (1957)

Performance glider

Span 15.10 m, length 7.38 m, height 2.15 m, wing area 17.28 sq m, empty weight 210 kg, total weight 300 kg, wing loading 19.50 kg/sq m, maximum lift-drag ratio 26.00, maximum speed 180 km/h, maximum permitted speed: diving 210 km/h, towed by aeroplane 120 km/h, minimum horizontal speed 50 km/h, minimum sinking speed 0.76 m/sec.

The *R.G.-5* one-seater was built at the *Întreprinderea forestieră de industrializare a lemnului (I.F.I.L.)* of Reghin, after the design of *Vladimir Novîtchi*. The good aerodynamic qualities of the *R.G.-5*, and especially its sensitivity to controls and small sinking speed, made possible an easy holding in slope and poor thermal flight.

In 1958 Miss *Aurelia Roșianu-Gheorghiu*, flying a *R.G.-5*, set up a women's national speed record on a 100-km path with fixed reference point for D1-class gliders, reaching a speed of 51.200 km/h.



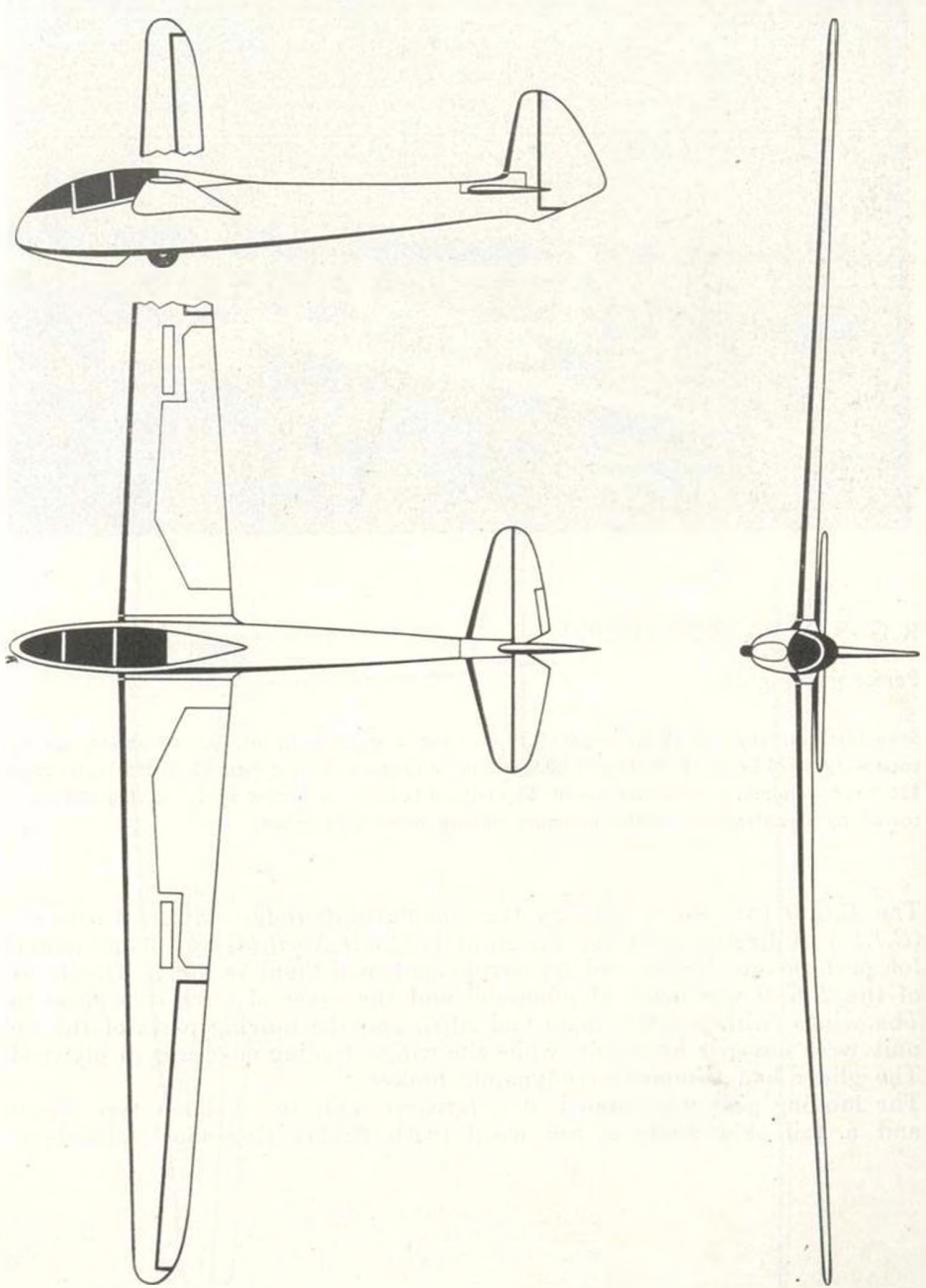

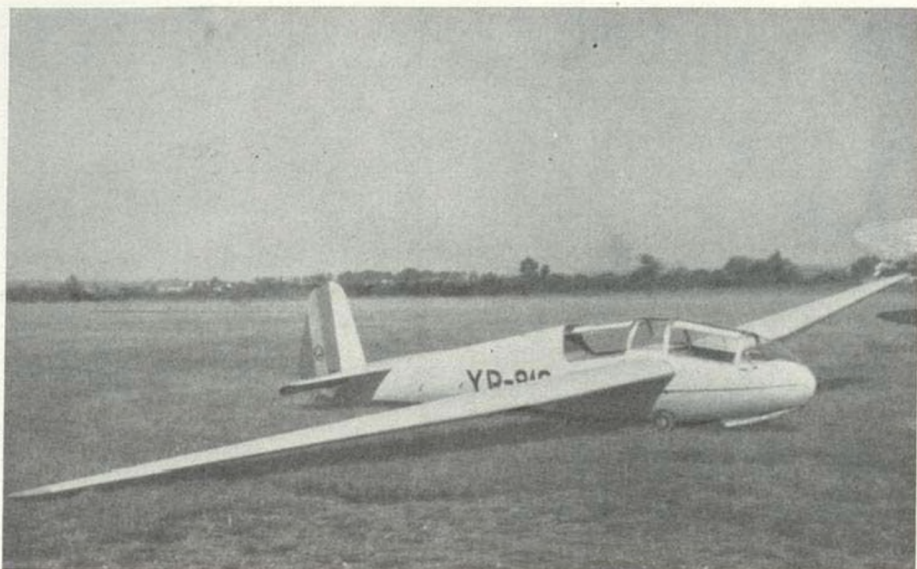

## R.G.-9 ALBATROS (1958)

### Performance glider

Span 16.45 m, length 7.98 m, height 1.29 m, wing area 22.16 sq m, empty weight 290 kg, total weight 470 kg, wing loading 23.50 kg/sq m, maximum lift-drag ratio 25.00, maximum speed 180 km/h, minimum horizontal speed 55 km/h, maximum permitted speed: diving 210 km/h, towed by aeroplane 110 km/h, minimum sinking speed 0.85 m/sec.

The *R.G.-9* two-seater, built by the *Complexul de industrializare a lemnului (C.I.L.)* of Reghin after the design of *Vladimir Novitchi*, was manufactured for performance flights and for aeroplane-towed flight training. The frame of the *R.G.-9* was made of pinewood and the cover of birch-tree plywood. The wings (with wooden spars and ribs), and the moving parts of the tail unit were covered by fabric, while the wings' leading edge was of plywood. The glider had trimmed aerodynamic brakes.

The landing gear was formed of a forward skid, two balloon tyre wheels and a tail skid made of ash wood (with rubber ring shock absorbers).

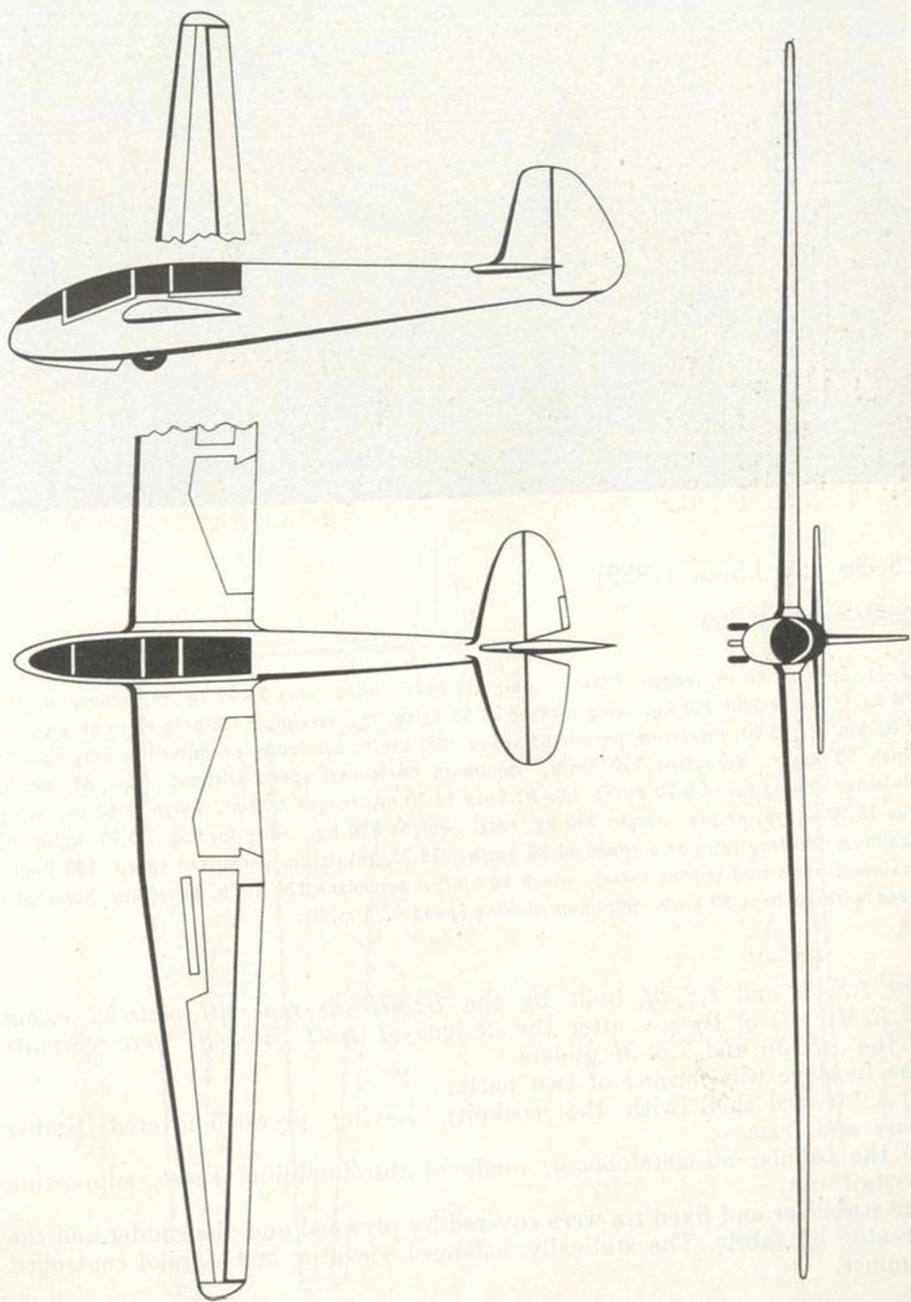



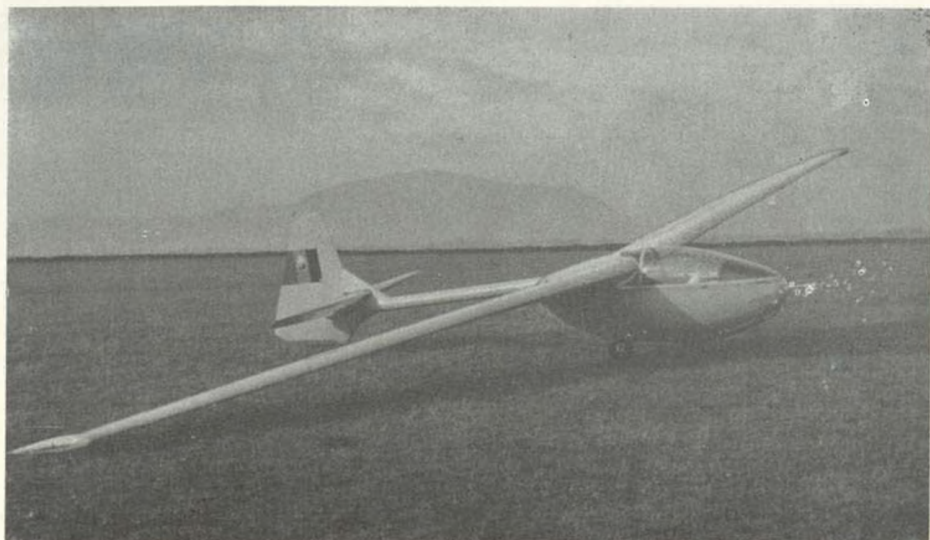

### I.S.-3e and I.S.-3f (1959)

#### Performance gliders

*I.S.-3e*: Span 17.00 m, length 7.00 m, height 1.60 m, wing area 16.00 sq m, empty weight 270 kg, total weight 360 kg, wing loading 22.50 kg/sq m, maximum lift-drag ratio at a speed of 82 km/h: 28.90, maximum permitted speed 180 km/h, maximum permitted towing speed: winch 90 km/h, aeroplane 120 km/h, minimum horizontal speed without flaps 61 km/h, minimum sinking speed 0.70 m/sec. *I.S.-3f*: Span 15.30 m, length 7.00 m, height 1.60 m, wing area 15.30 sq m, empty weight 230 kg, total weight 320 kg, wing loading 20.90 kg/sq m, maximum lift-drag ratio at a speed of 82 km/h: 28.20, maximum permitted speed 180 km/h, maximum permitted towing speed: winch 90 km/h, aeroplane 120 km/h, minimum horizontal speed without flaps 59 km/h, minimum sinking speed 0.75 m/sec.

The *I.S.-3e* and *I.S.-3f*, built by the *Uzinele de reparații material volant (U.R.M.V.-3)* of Braşov after the designs of *Iosif Şilimon*, were variants of the *I.S.-3a* and *I.S.-3b* gliders.

The fuselage was formed of two parts:

- (a) a forward shell (with the cockpit), having plywood-covered timber spars and frames;
- (b) the tubular all-metal boom, made of duraluminium sheet, supporting the tail unit.

The stabilizer and fixed fin were covered by plywood and the rudder and the elevator by fabric. The statically balanced elevator had a pilot-controlled trimmer.

I. S.-3 e and I. S.-3

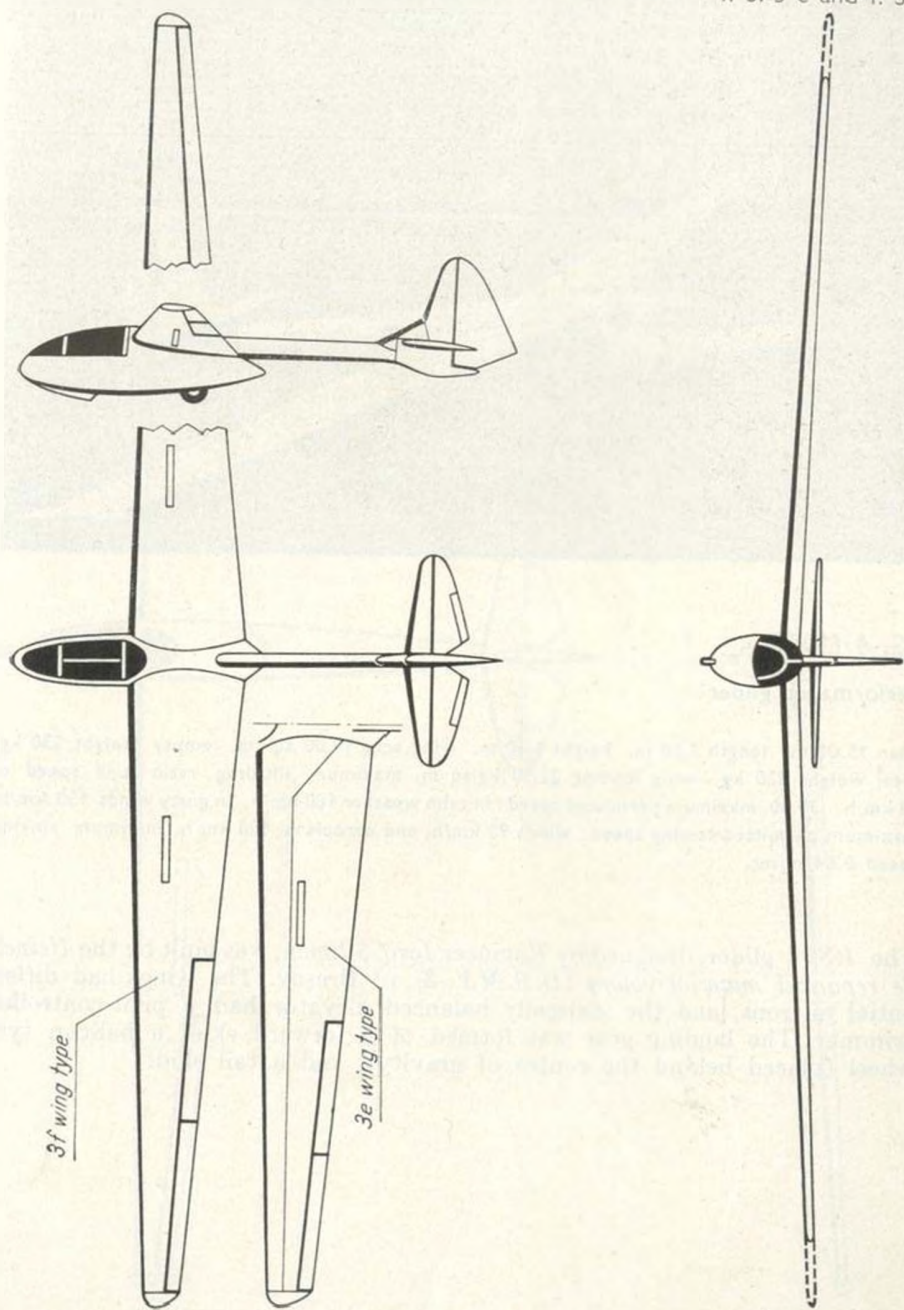



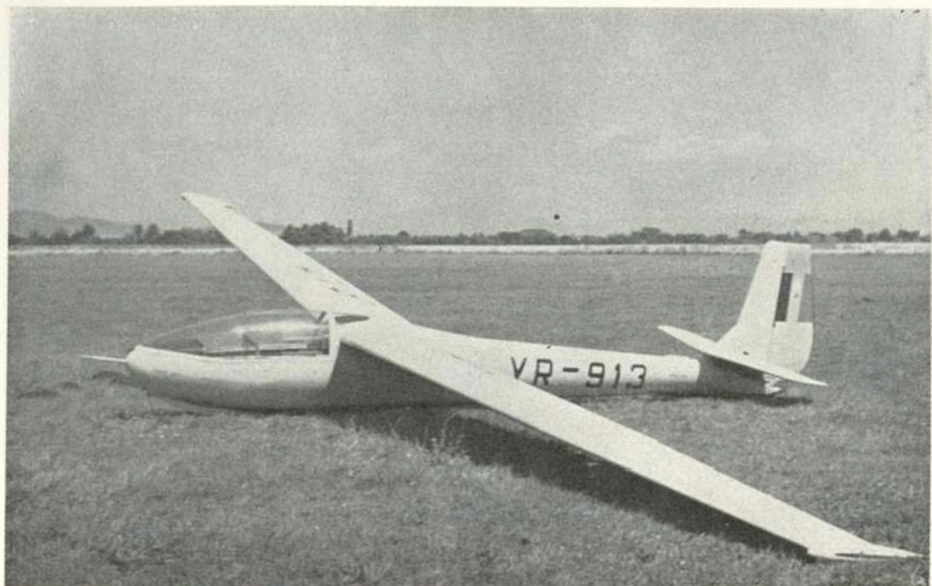

### I.S.-4 (1959)

#### Performance glider

Span 15.00 m, length 7.10 m, height 1.60 m, wing area 14.00 sq m, empty weight 230 kg, total weight 320 kg, wing loading 22.90 kg/sq m, maximum lift-drag ratio at a speed of 78 km/h: 30.00, maximum permitted speed: in calm weather 180 km/h, in gusty winds 150 km/h, maximum permitted towing speed: winch 90 km/h, and aeroplane 120 km/h, minimum sinking speed 0.64 m/sec.

The *I.S.-4* glider, designed by Engineer *Iosif Şilimon*, was built by the *Uzinele de reparații material volant (U.R.M.V.-3)* of Braşov. The wings had differential ailerons, and the statically balanced elevator had a pilot-controlled trimmer. The landing gear was formed of a forward skid, a balloon tyre wheel (placed behind the centre of gravity), and a tail skid.



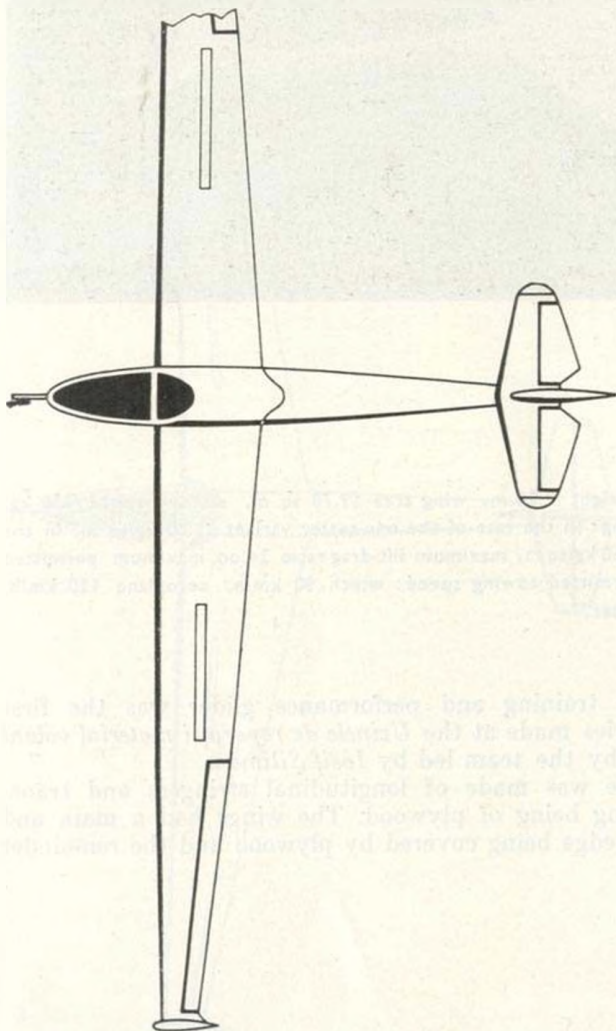
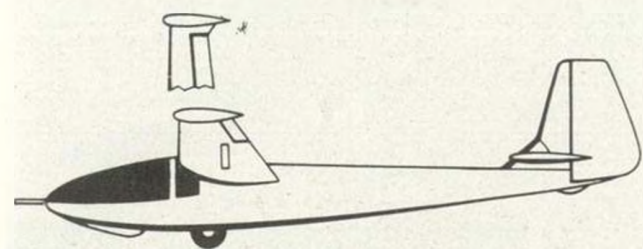

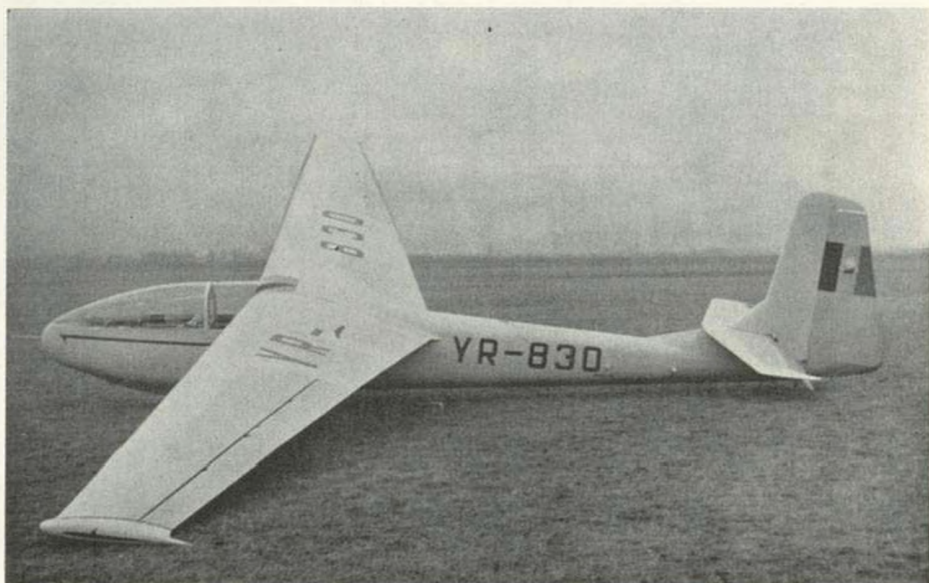

### I.S.-7 (1959)

#### Universal glider

Span 15.90 m, length 8.65 m, height 2.15 m, wing area 19.70 sq m, empty weight 330 kg, total weight 500 kg, wing loading: in the case of the one-seater variant 21.00 kg/sq m, in the case of the two-seater variant 25.50 kg/sq m, maximum lift-drag ratio 24.00, maximum permitted speed 180 km/h, maximum permitted towing speed: winch 90 km/h, aeroplane 120 km/h, minimum sinking speed 0.92 m/sec.

The *I.S.-7* semi-aerobatic training and performance glider was the first two-seater of the I.S. series made at the *Uzinele de reparații material volant (U.R.M.V.-3)* of Braşov by the team led by *Iosif Şilimon*.

The frame of the fuselage was made of longitudinal stringers and transversal frames, the covering being of plywood. The wings had a main and a false spar, the leading edge being covered by plywood and the remainder in fabric.

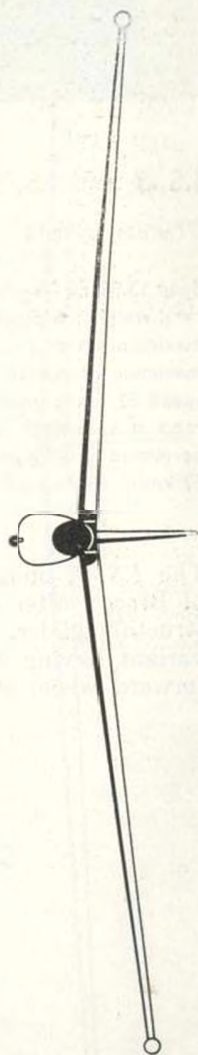
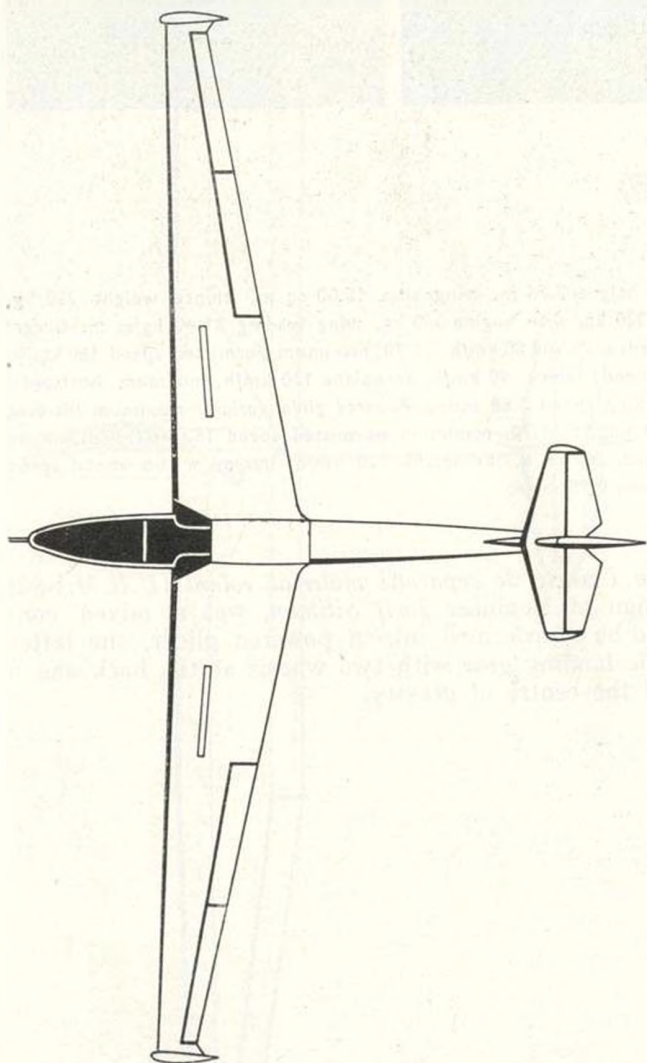
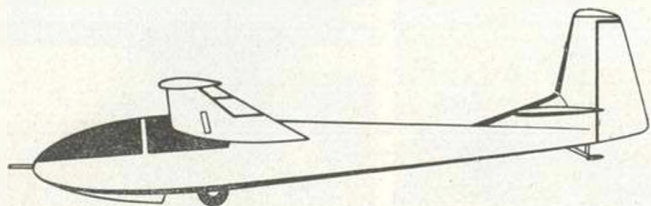



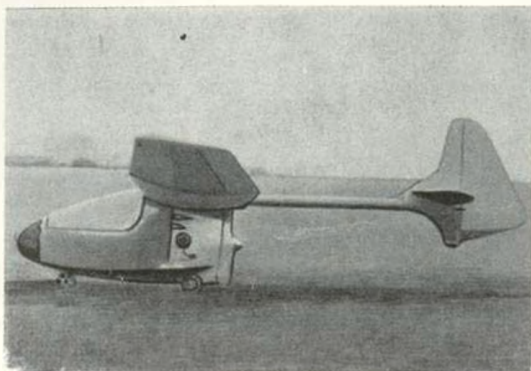

### I.S.-9 and I.S.-9a (1959)

#### Training gliders

Span 13.00 m, length 6.64 m, height 2.74 m, wing area 15.00 sq m, empty weight 230 kg, total weight : without engine 320 kg, with engine 360 kg, wing loading 21.40 kg/sq m. *Glider*: maximum lift-drag ratio at speeds of 76 and 80 km/h : 21.70, maximum permitted speed 180 km/h, maximum permitted towing speed : winch 90 km/h, aeroplane 130 km/h, minimum horizontal speed 53 km/h, minimum sinking speed 0.88 m/sec. *Powered glider variant*: maximum lift-drag ratio at speeds of 76 and 80 km/h : 21.70, maximum permitted speed 150 km/h, maximum permitted towing speed : winch 80 km/h, aeroplane 120 km/h, minimum horizontal speed 57 km/h, minimum sinking speed 0.95 m/sec.

The *I.S.-9*, built by the *Uzinele de reparații material volant (U.R.M.V.-3)* of Braşov after the design of Engineer *Iosif Şilimon*, was a mixed construction glider. It could be transformed into a powered glider, the latter variant having a tricycle landing gear with two wheels at the back and a forward wheel ahead of the centre of gravity.

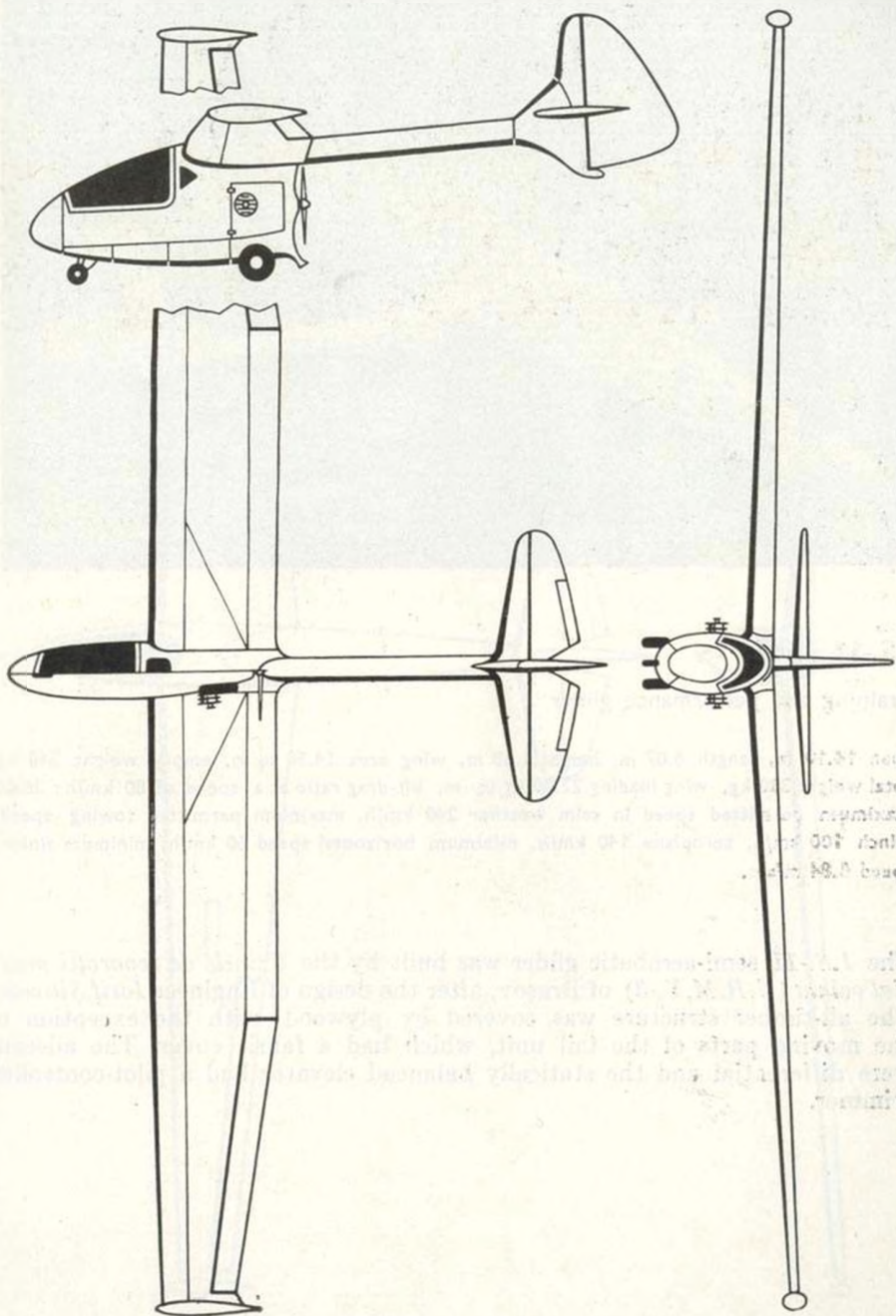

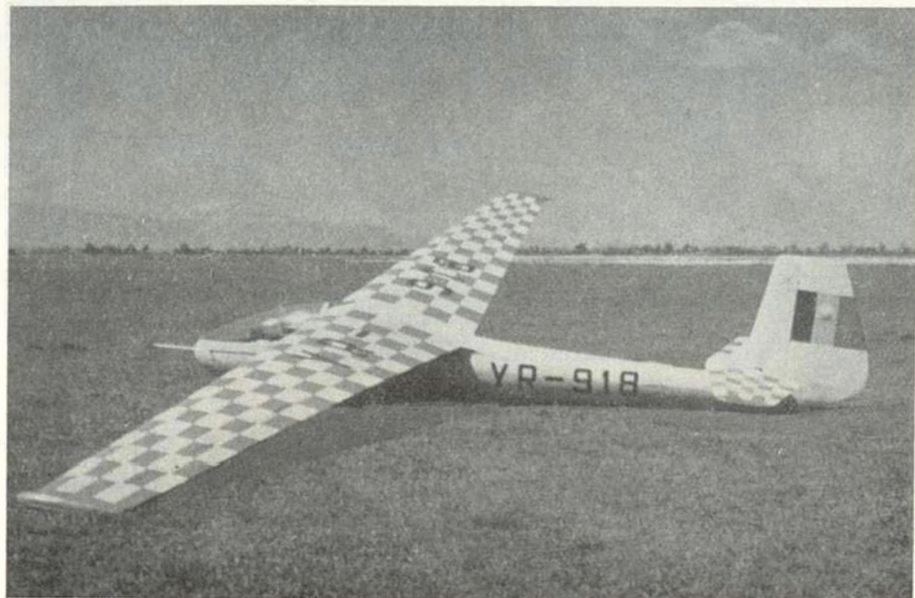

### I.S.-11 (1959)

Training and performance glider

Span 14.10 m, length 6.87 m, height 1.60 m, wing area 14.50 sq m, empty weight 240 kg, total weight 330 kg, wing loading 22.80 kg/sq m, lift-drag ratio at a speed of 80 km/h: 26.00, maximum permitted speed in calm weather 240 km/h, maximum permitted towing speed: winch 100 km/h, aeroplane 140 km/h, minimum horizontal speed 60 km/h, minimum sinking speed 0.84 m/sec.

The *I.S.-11* semi-aerobatic glider was built by the *Uzinele de reparatii material volant (U.R.M.V.-3)* of Braşov, after the design of Engineer *Iosif Şilimon*. The all-timber structure was covered by plywood, with the exception of the moving parts of the tail unit, which had a fabric cover. The ailerons were differential and the statically balanced elevator had a pilot-controlled trimmer.



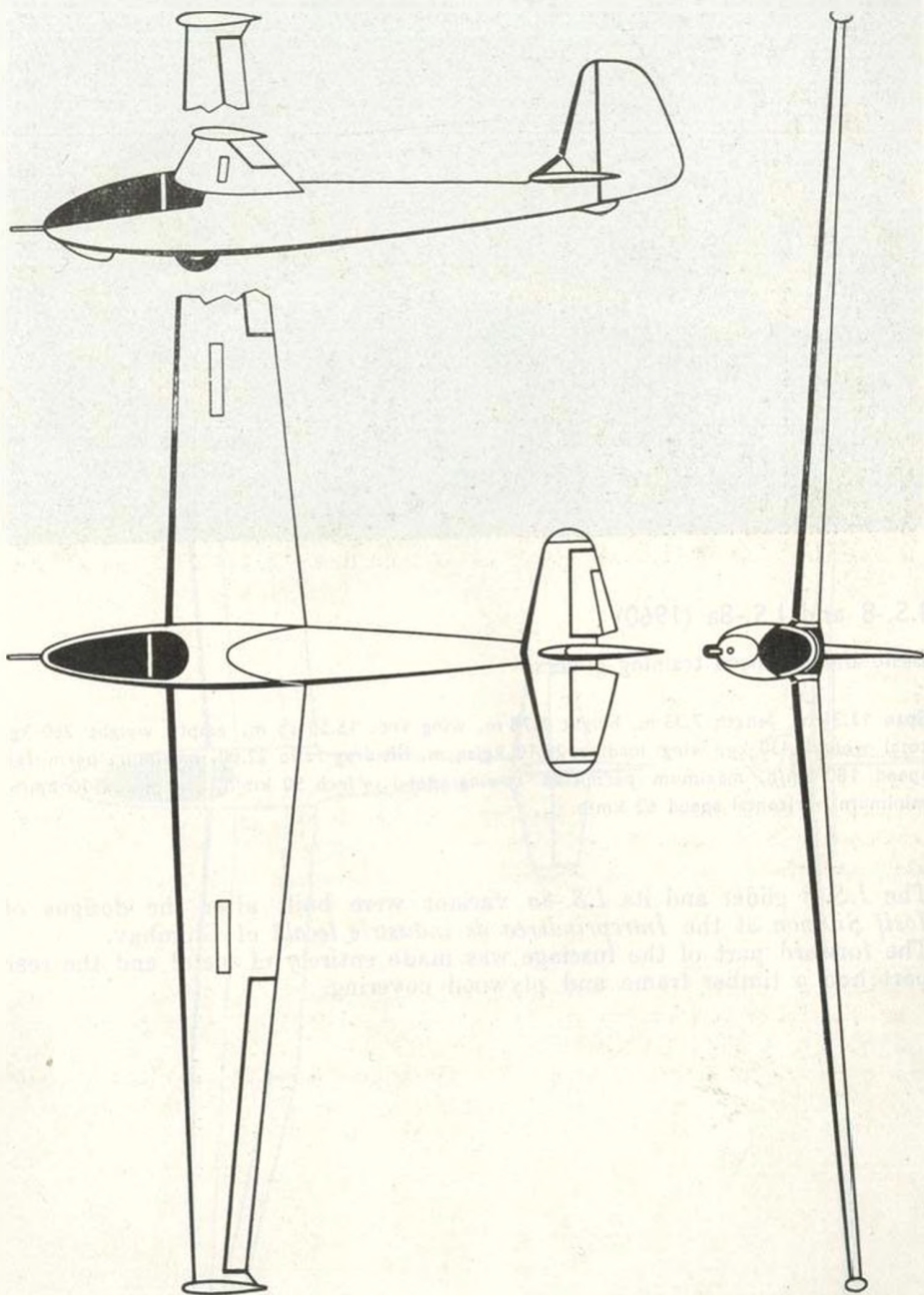

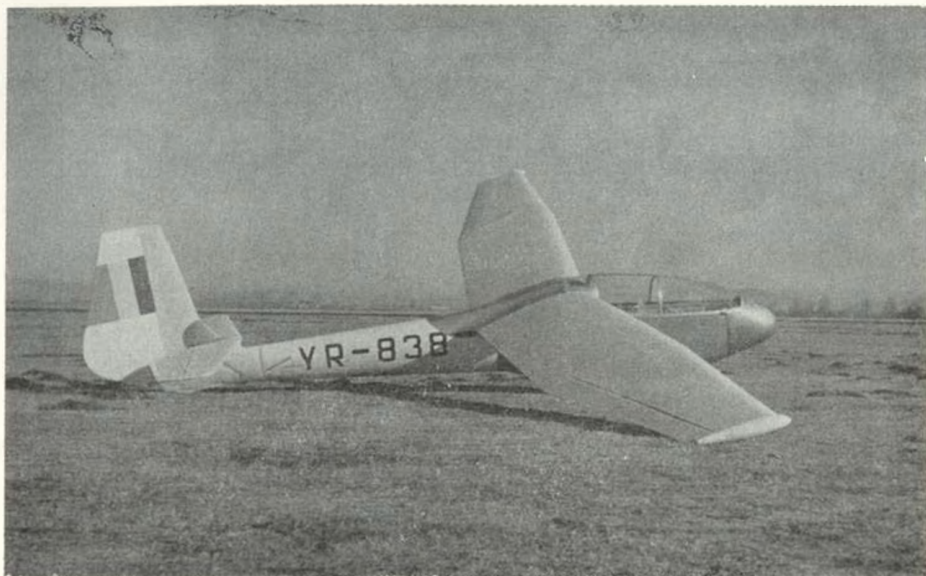

### I.S.-8 and I.S.-8a (1960)

Basic and advanced training gliders

Span 13.35 m, length 7.35 m, height 1.78 m, wing area 15.50 sq m, empty weight 280 kg, total weight 430 kg, wing loading 29.10 kg/sq m, lift-drag ratio 22.00, maximum permitted speed 180 km/h, maximum permitted towing speed: winch 90 km/h, aeroplane 120 km/h, minimum horizontal speed 62 km/h.

The *I.S.-8* glider and its *I.S.-8a* variant were built after the designs of *Iosif Şilimon* at the *Întreprinderea de industrie locală* of Ghimbav. The forward part of the fuselage was made entirely of metal and the rear part had a timber frame and plywood covering.

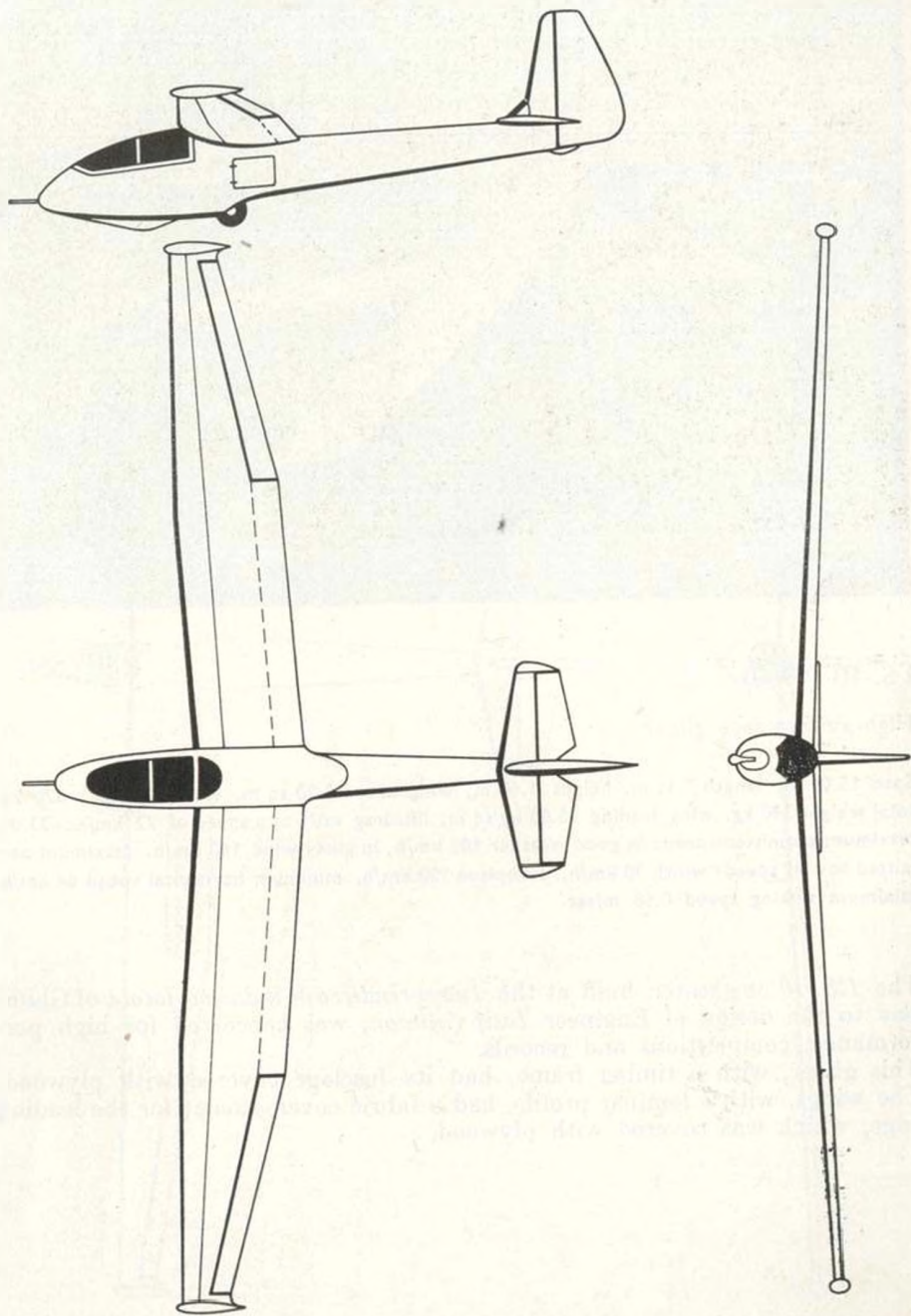



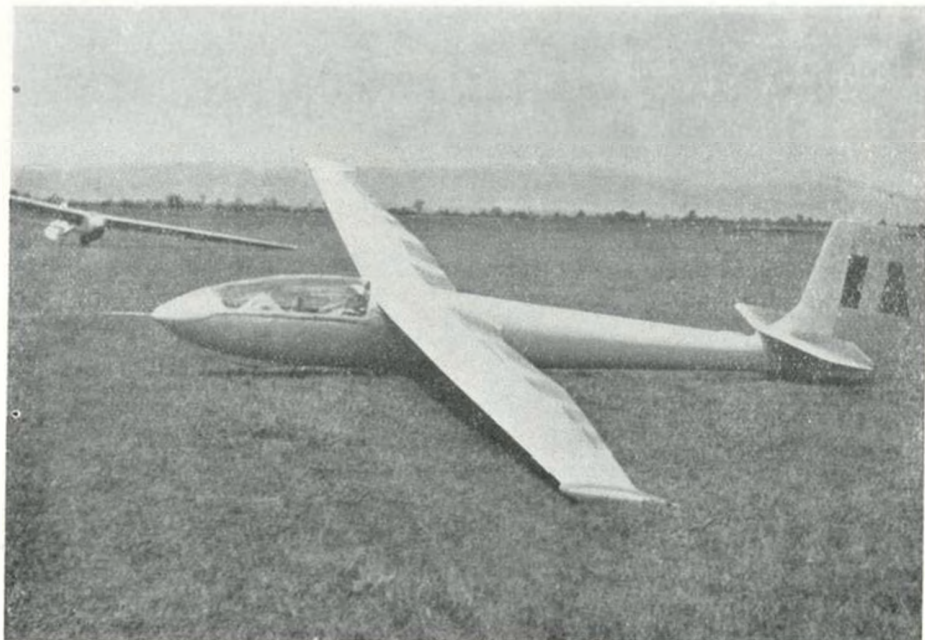

### I.S.-10 (1960)

#### High-performance glider

Span 15.00 m, length 7.44 m, height 1.60 m, wing area 13.20 sq m, empty weight 220 kg, total weight 340 kg, wing loading 25.80 kg/sq m, lift-drag ratio at a speed of 72 km/h: 33.00, maximum permitted speed: in good weather 180 km/h, in gusty wind 160 km/h, maximum permitted towing speed: winch 90 km/h, aeroplane 120 km/h, minimum horizontal speed 64 km/h, minimum sinking speed 0.68 m/sec.

The *I.S.-10* one-seater, built at the *Întreprinderea de industrie locală* of Ghimbav to the design of Engineer *Iosif Șilimon*, was conceived for high performance, competitions and records.

This glider, with a timber frame, had its fuselage covered with plywood. The wings, with a laminar profile, had a fabric cover, except for the leading edge, which was covered with plywood.

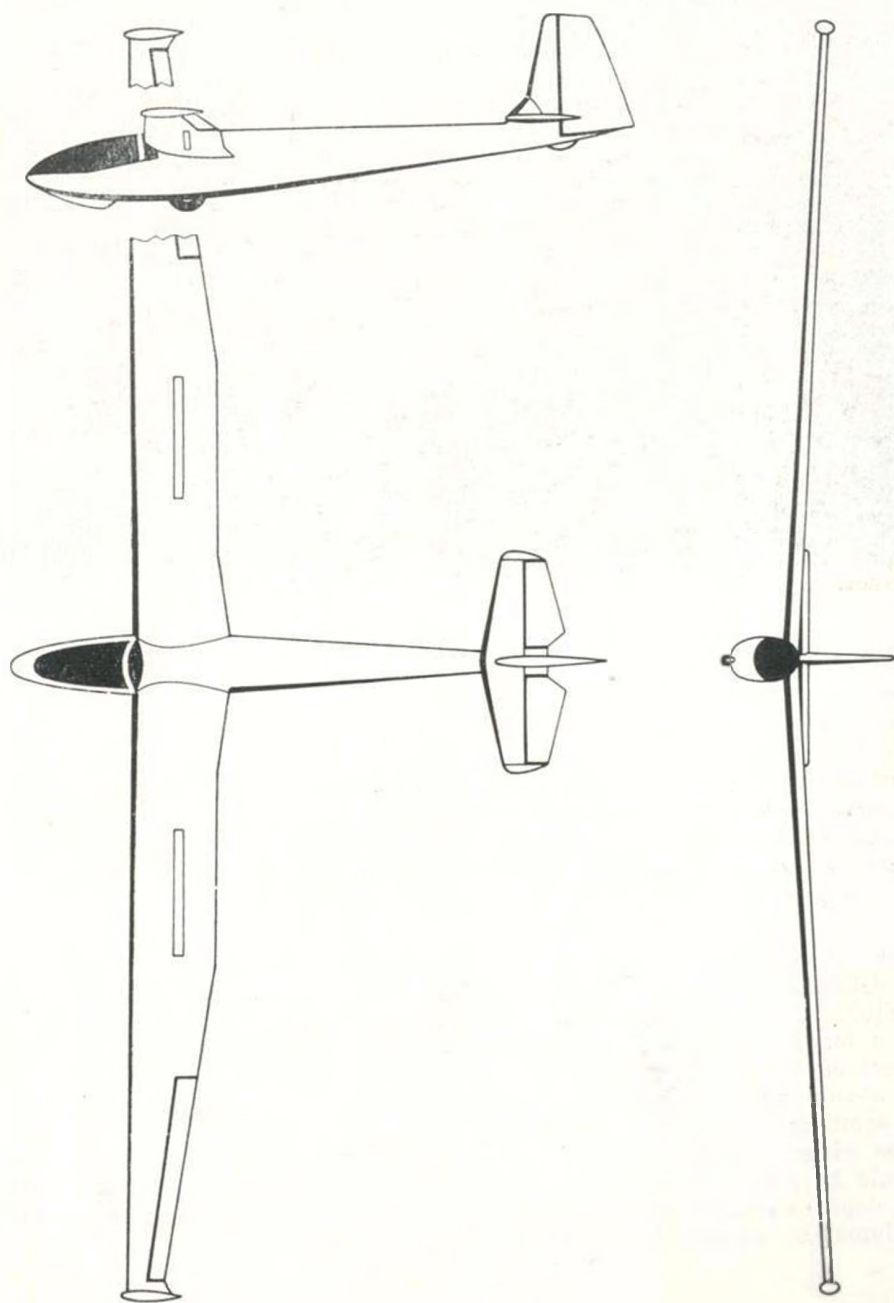

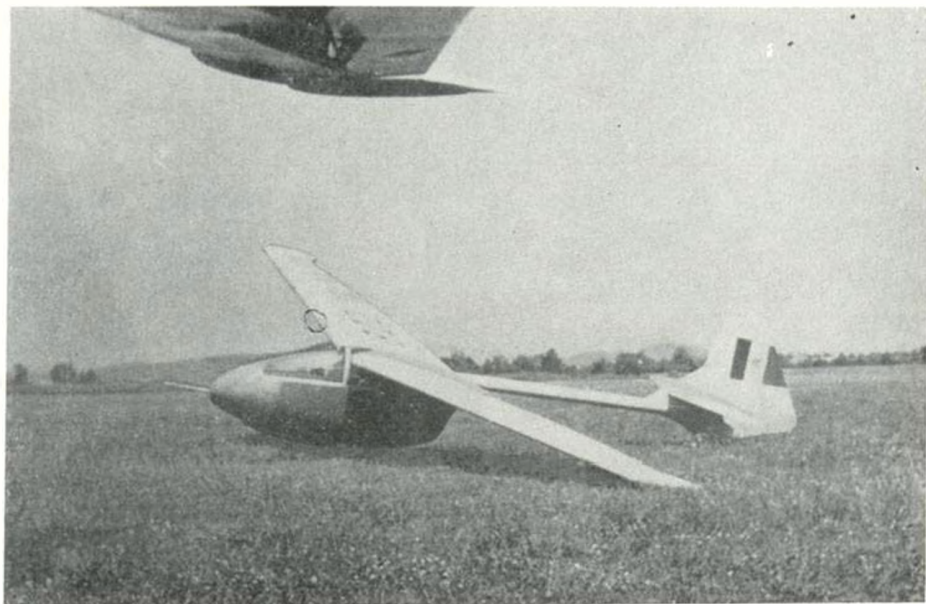

### I.S.-5 (1961)

#### Performance glider

Span 15.30 m, length 6.36 m, height 1.60 m, wing area 15.28 sq m, empty weight 220 kg, total weight 310 kg, wing loading 20.30 kg/sq m, maximum lift-drag ratio 28.00, speed at maximum fineness 75 km/h, maximum permitted speed in good weather 180 km/h, maximum permitted towing speed: winch 90 km/h, aeroplane 120 km/h, minimum permitted horizontal speed 55 km/h, minimum sinking speed 0.74 m/sec.

The *I.S.-5* glider was built by the *Întreprinderea de industrie locală (I.I.L.)* of Ghimbav to the design of Engineer *Iosif Șilimon*. The characteristic feature of this glider was the fuselage, composed of two parts:

- a forward shell, with a metal lattice girder frame and a duraluminium sheet covering;
- a tubular all-metal boom, made of 1.5 mm thick duraluminium sheet, supporting the tail unit.

The wings had differential ailerons. The angle of incidence of the stabilizer could be adjusted on the soil, and the trimming of the aerodynamic action in depth was obtained by the application of a supplementary force, to the column, by means of a spring mechanism.



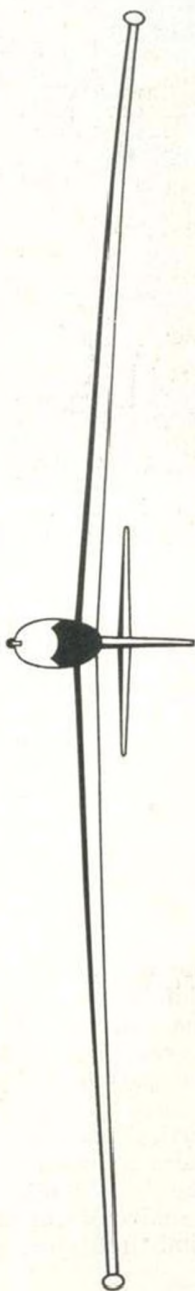
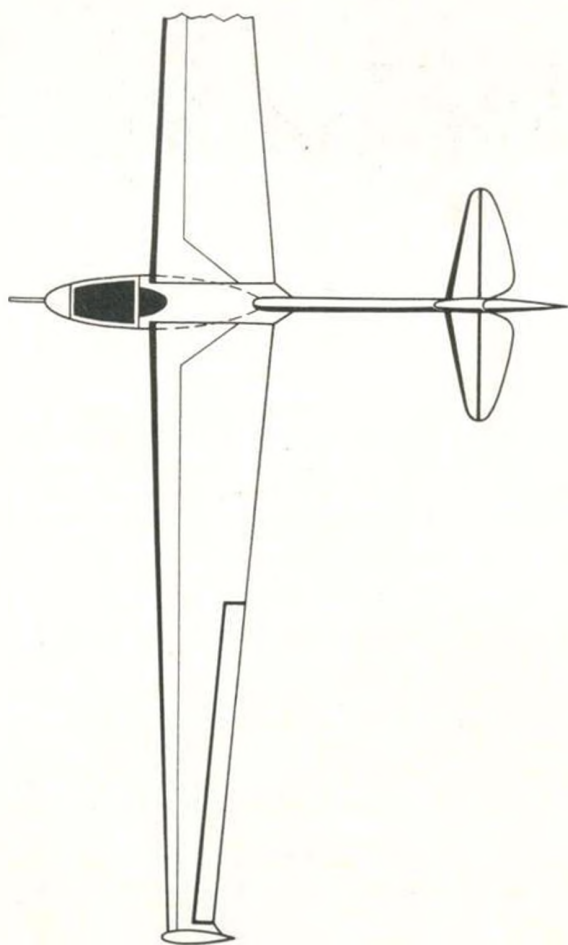
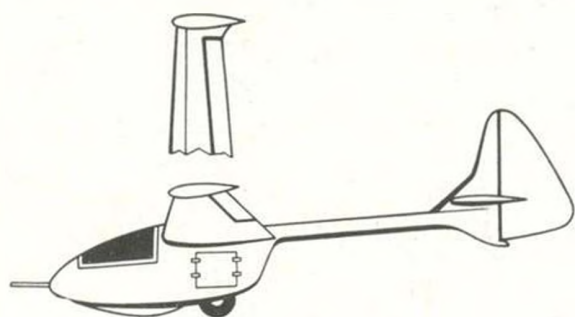

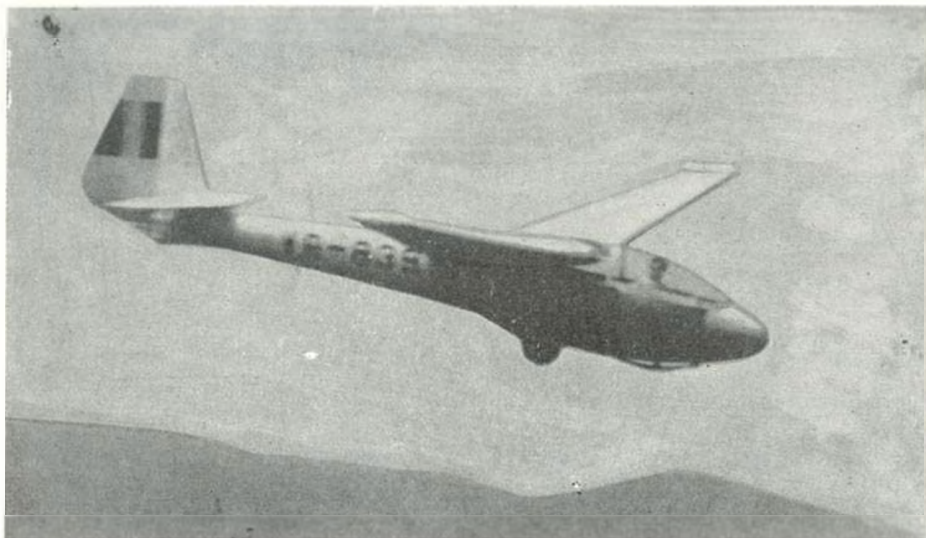

## I.S.-12 (1962)

Basic and advanced training glider

Span 15.00 m, length 7.35 m, height 1.78 m, wing area 18.00 sq m, empty weight 290 kg, total weight 460 kg. One-seater variant: wing loading 20.80 kg/sq m, lift-drag ratio at a speed of 77 km/h 24.00, maximum permitted speed 200 km/h, maximum permitted towing speed: winch 100 km/h, aeroplane 130 km/h, minimum horizontal speed 52 km/h, minimum sinking speed 0.80 m/sec. Two-seater variant: wing loading 25.60 kg/sq m, lift-drag ratio at a speed of 92 km/h 24.00, maximum permitted speed 180 km/h, maximum permitted towing speed: winch 90 km/h, plane 120 km/h, minimum horizontal speed 58 km/h, minimum sinking speed 0.92 m/sec.

The *I.S.-12* glider was built by the *Întreprinderea de industrie locală* of Ghimbav to the design of Engineer *Iosif Șilimon*.

The fore part of the fuselage of this glider had a lattice-girder type frame of welded steel pipes, the cover being made of duraluminium sheet. The rear part of the fuselage, having an oval section, was of wood and entirely covered with plywood. The stabilizer, adjustable on the soil, and the fixed vertical fin were covered with fabric, excepting the leading edge, which had a plywood cover.

The *I.S.-12* semi-aerobatic glider had dual controls and both pilots had a similar dashboard, each comprising a speedometer, altimeter, rate of climb indicator, and compass.

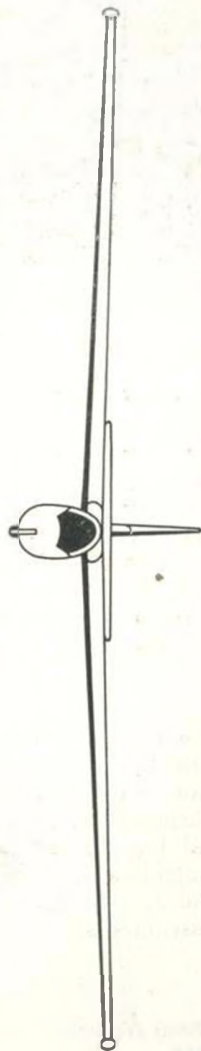
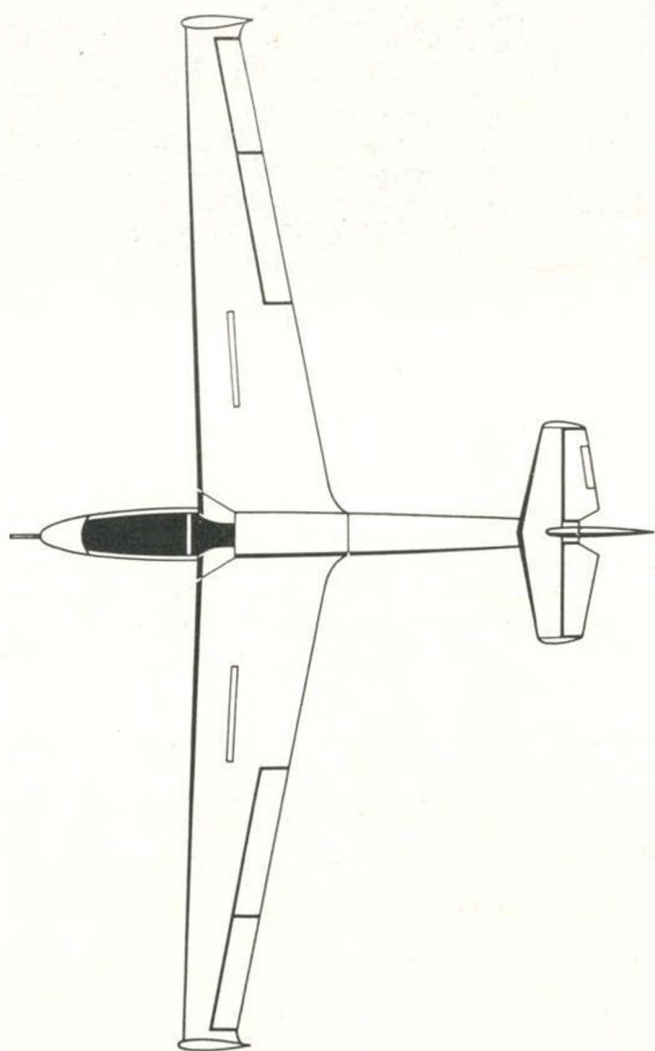
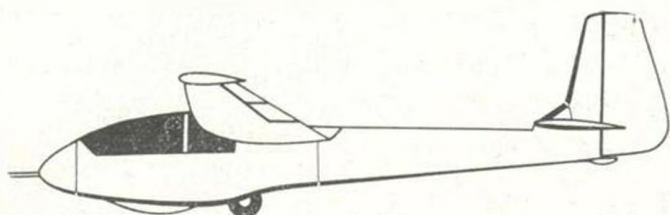





## I.S.-13 (1962)

### Universal glider\*

Span 15.00 m, length 8.00 m, height 1.85 m, wing area 18.00 sq m, empty weight 290 kg, total weight 460 kg. One-seater variant: wing loading 20.80 kg/sq m, maximum lift-drag ratio 24.00, maximum permitted speed 200 km/h, maximum permitted towing speed: winch 100 km/h, aeroplane 130 km/h, minimum sinking speed 0.80 m/sec. Two-seater variant: wing loading 25.60 kg/sq m, maximum lift-drag ratio 24.00, maximum permitted speed 180 km/h, maximum permitted towing speed: winch 90 km/h, aeroplane 120 km/h, minimum sinking speed 0.92 m/sec.

The *I.S.-13* glider, designed by Engineer *Iosif Șilimon*, and built at the *Întreprinderea de industrie locală* of Ghimbav, was of mixed construction. The wing, whose frame was formed of a principal spar and a false one, had a fabric cover, except for the leading edge which was covered with plywood, and had differential ailerons. The statically balanced elevator had a pilot-controlled trimmer.

The *I.S.-13* glider had dual controls, and both pilots had the necessary instruments.

\* Semi-aerobatic two-seater glider, used as basic and advanced training and performance plane.

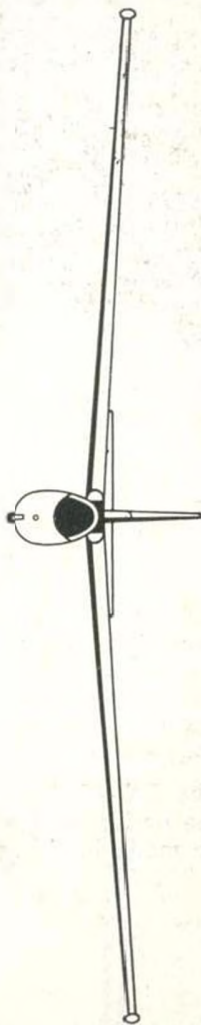
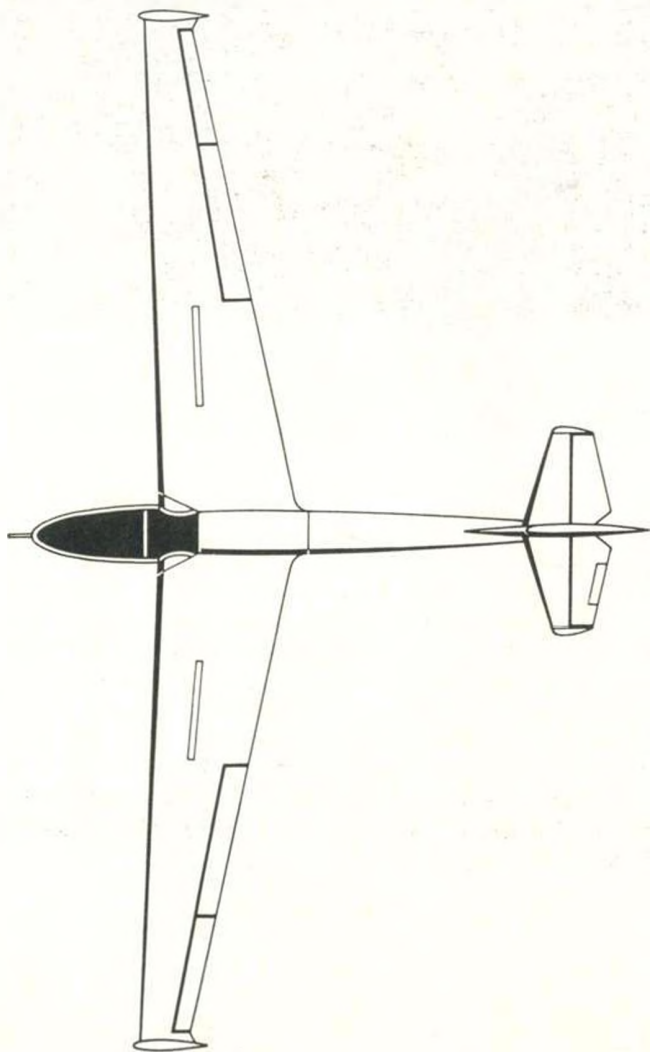
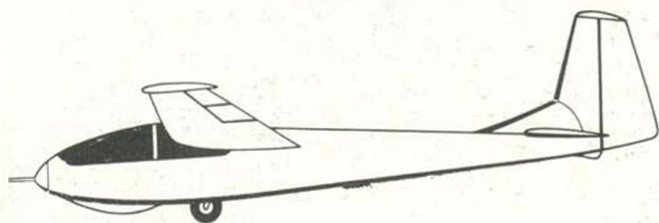

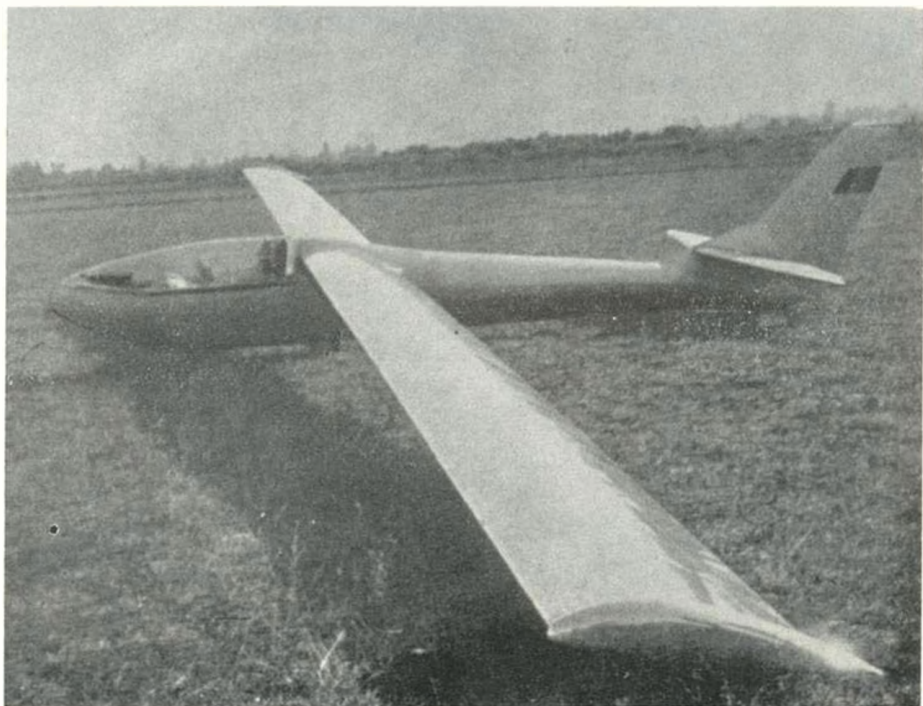

### I.S.-18 (1965)

Training and performance glider

Span 16.00 m, length 7.10 m, height 1.50 m, wing area 12.80 sq m, empty weight 270 kg, total weight 370 kg, wing loading 28.50 kg/sq m, lift-drag ratio at a speed of 93 km/h: 35.00, maximum speed 180 km/h, maximum permitted towing speed: winch 90 km/h, aeroplane 120 km/h, minimum horizontal speed 65 km/h, minimum sinking speed 0.63 m/sec.

The *I.S.-18*, built at the *Întreprinderea de industrie locală* of Ghimbav to the design of Engineer *Iosif Șilimon*, was the first metal-wing glider to be made in this country.



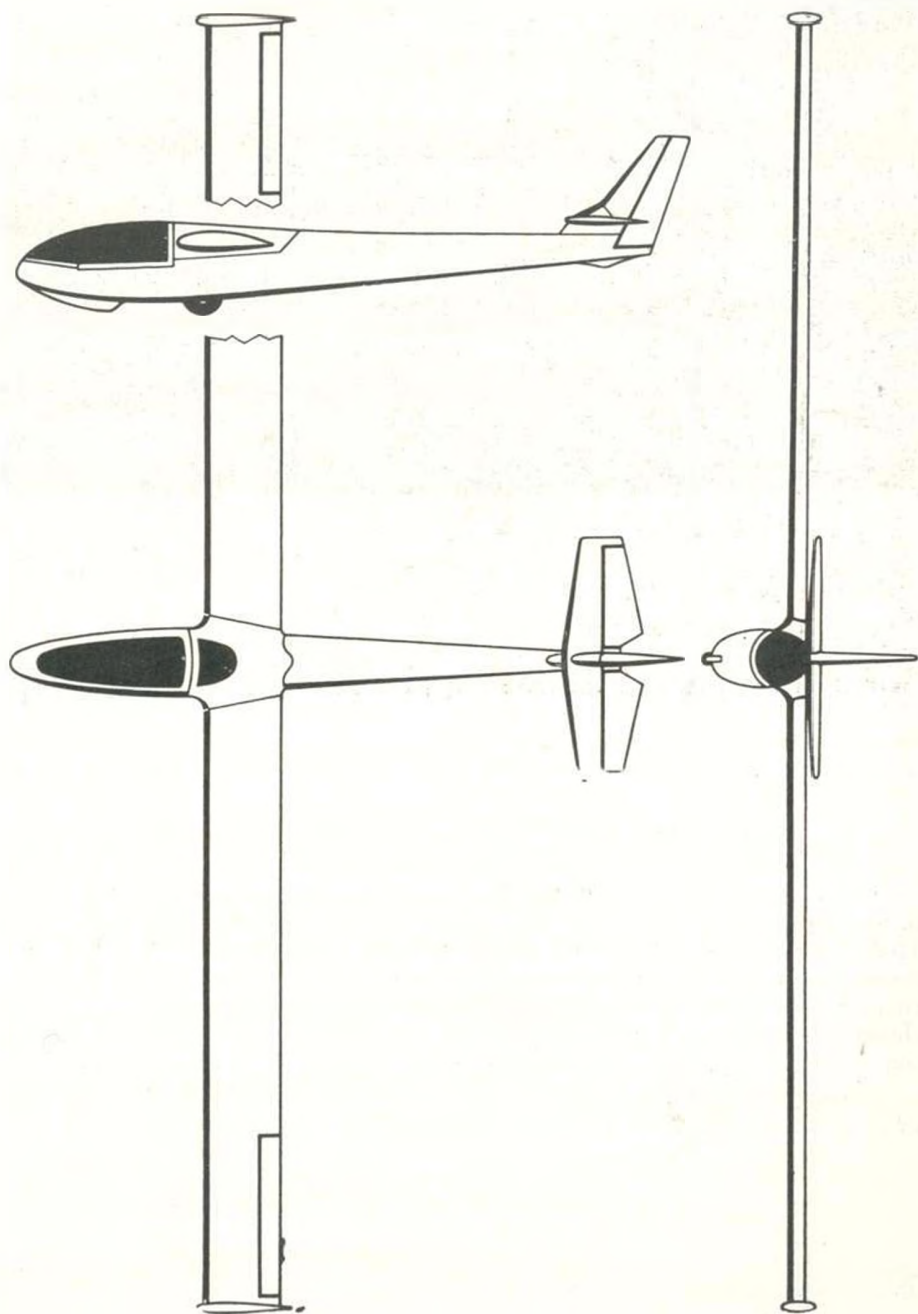

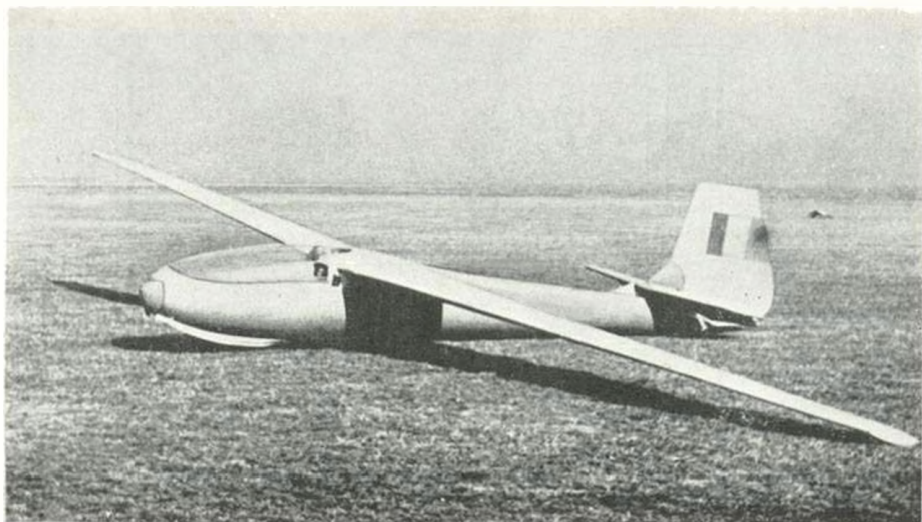

### I.S.-18/25 (1969)

#### Training and performance glider

Span 15.00 m, length 6.90 m, height 1.65 m, wing area 11.56 sq m, empty weight 283 kg, total weight 375 kg, maximum lift-drag ratio 32.50, maximum permitted speed 220 km/h, maximum permitted towing speed: winch, 100 km/h, aeroplane 140 km/h, minimum horizontal speed 66 km/h, minimum sinking speed 0.68 m/sec.

The *I.S.-18/25* one-seater, with semi-laminar wings, was designed by Engineer *Iosif Șilimon* and built by the *Întreprinderea de construcții aeronautice* of Brașov.

The glider is of classical timber construction. The fuselage has an oval section. The wings have differential ailerons and aerodynamic brakes. The cockpit has a plexiglass cowling which is forward opened by sliding. The classical landing gear has a forward skid, a balloon tyre wheel behind the centre of gravity, and a tail skid.

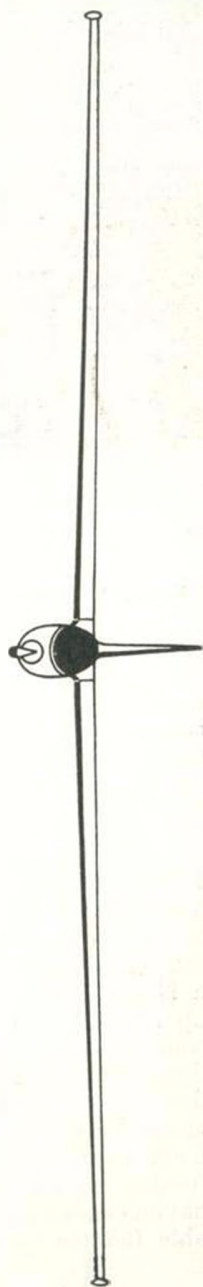
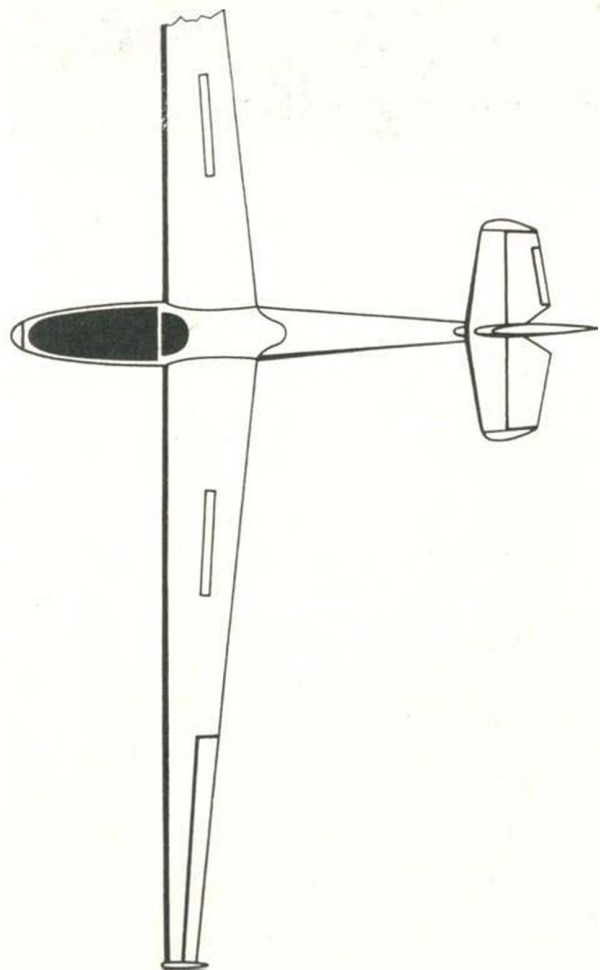
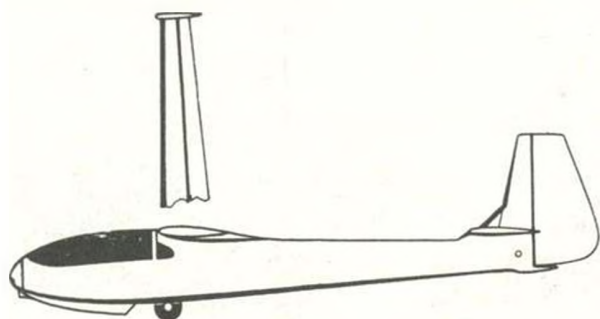



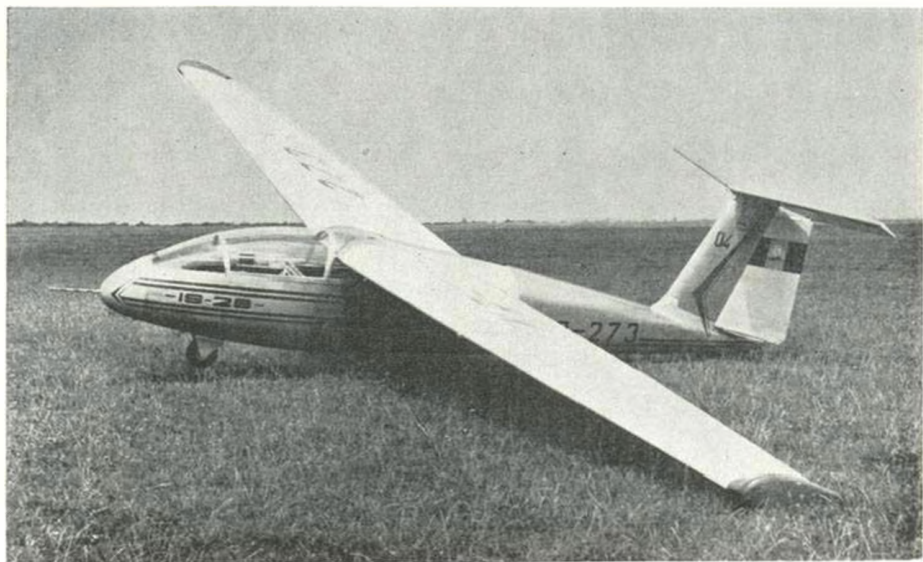

## I.S.-28 (1970)

Basic and training glider

Span 15.00 m, length 6.76 m, height 2.18 m, wing area 18.00 sq m, empty weight 325 kg, maximum weight 510 kg, lift-drag ratio 26 (at a speed of 75 km/h), maximum speed 200 km/h, minimum speed 58 km/h, sinking speed 0.85 m/s (at a speed of 65 km/h), wing loading 28.3 kg/sq m.

This is a serial produced two-seater made by the *Întreprinderea de Construcții Aeronautice (I.C.A.)* of Brașov after a design by Eng. *Iosif Șilimon*, in keeping with the requirements of the modern methods of glider pilot training. The timber wing, with a single spar, has lattice-girder ribs. Based on a NACA-43012 A foil, the wing has aerodynamic brakes. Its leading edge, up to the main spar and on a 45° diagonal towards the fuselage junction, constitutes a stressed box. The semi-shell type metal fuselage is made of light alloys, the resistant structure being made, in the fore part, of panels linked by two main longerons following the chapping's contour, as well as two median longerons, and two belly longerons. The rear part of the body kept by seven panels attached to the longerons (two) placed in the fuselage's axis of symmetry. The T-shaped tail unit is completely metallic, having a collapsible horizontal semi-plan. Each semi-elevator has a controllable flettner slot.

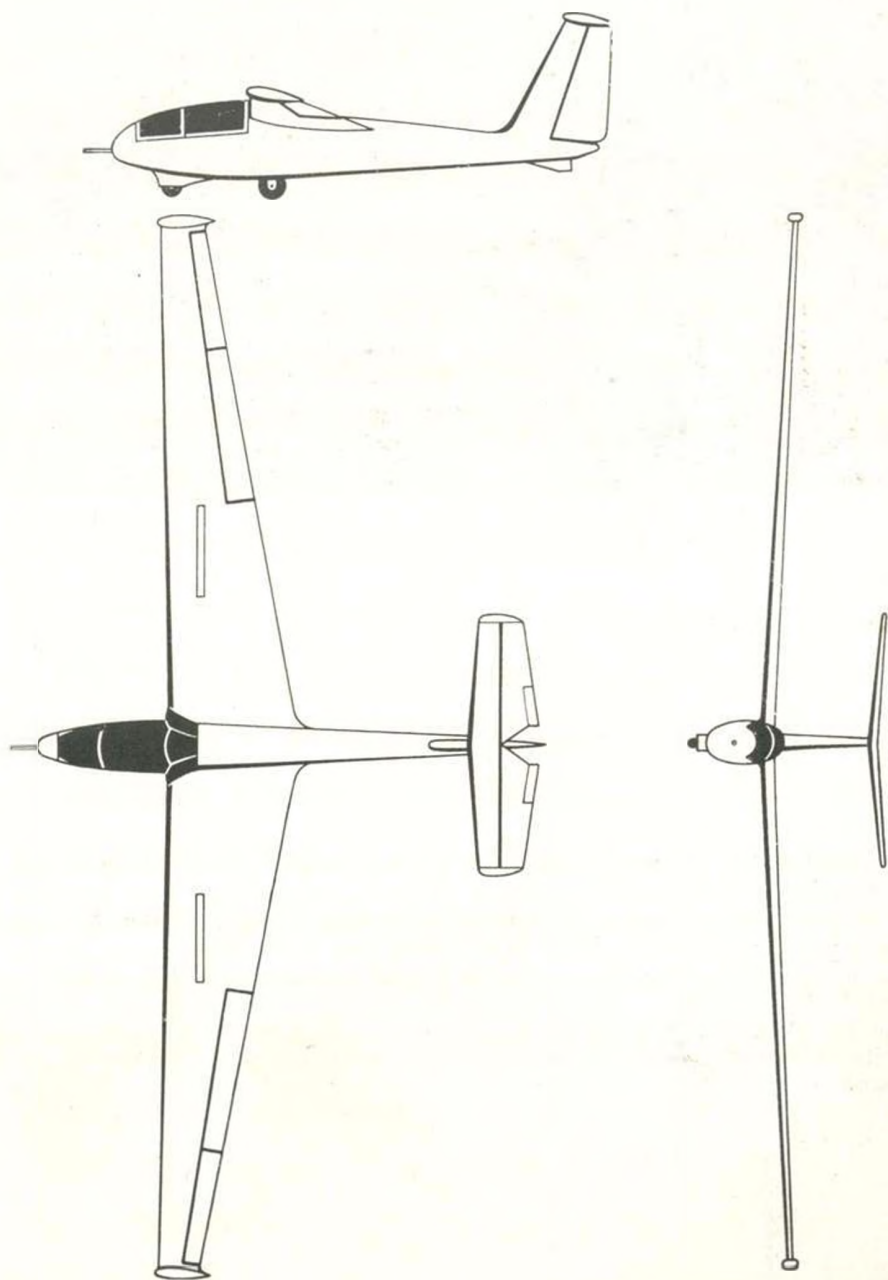



### I.S.-29B (1970)

Standard class training glider

Span 15.00 m, length 7.03 m, height 1.68 m, wing area 11.92 sq m, empty weight 240 kg, total weight 340 kg, lift-drag ratio 36 (at 90 km/h), maximum speed 220 km/h, minimum speed 65 km/h, minimum sinking speed 0.62 m/s (at a speed of 68 km/h).

Built by the *Intreprinderea de construcții aeronautice (I.C.A.)* of Brașov after the design of Eng. *Iosif Șilimon*, the glider has a Wortman foil wing made of three sections (a central dismountable one and two outer). It is an all-timber shell-type wing, without spars (ribs and stringers only). Shell-type metal fuselage. The nose has a removable fibre glass cowling. The mono-block pendular elevator is placed in the upper part of the vertical fin.

The *I.S.-28* glider is a one-seater trainer and has the specific apparatus of its category. The retractable landing gear has an oil-pneumatic shock absorber.



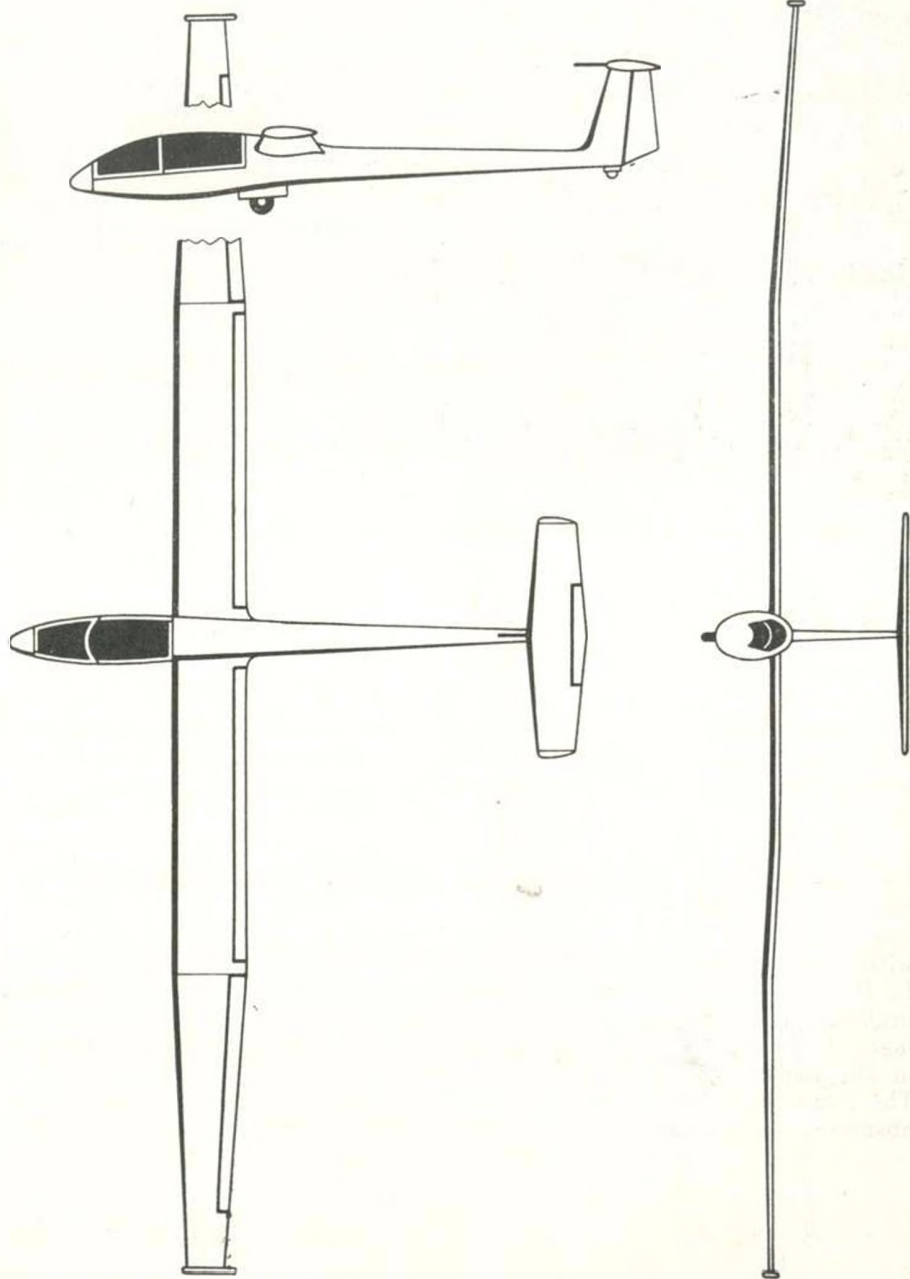



### I.S.-29 D (1970)

Training and high-performance glider

Span 15.00 m, length, 7.03 m, height 1.68 m, wing area 10.40 sq. m, empty weight 220 kg, total weight 320 kg, lift-drag ratio 37 (at a speed of 90 km/h), maximum speed 220 km/h, minimum speed 65 km/h, minimum sinking speed 0.58 m/s (at a speed of 78 km/h).

Designed by Eng. *Iosif Șilimon*, this serial-built glider, made at the *Întreprinderea de construcții aeronautice (I.C.A.)* of Brașov, is a one-seater with a trapezoidal wing having a main spar and another strengthening the rear one, with stamped ribs, entirely covered by dural sheet. The wing has flap-brakes. In the case of the *I.S.-29 D1* variant, the flap was replaced by aerodynamic brakes. The T-shaped tail unit is integrated with the rear part of the fuselage. The joining tinplate, together with the horizontal plan's joint, are fixed in the upper part of the fin.

The retractable landing gear has a brake and a hydro-pneumatic shock absorber. The *I.S. 29D* is the first Romanian all-metal glider

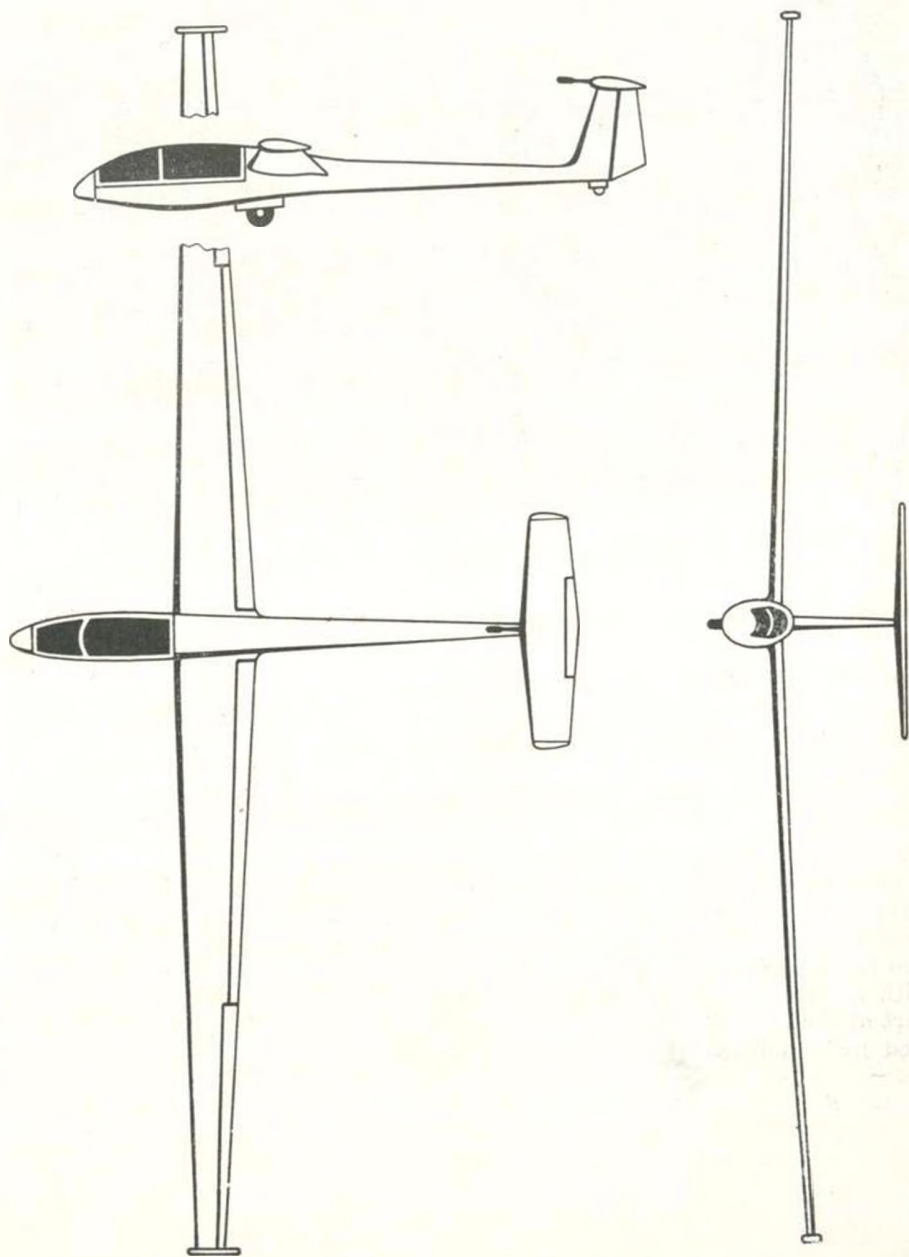



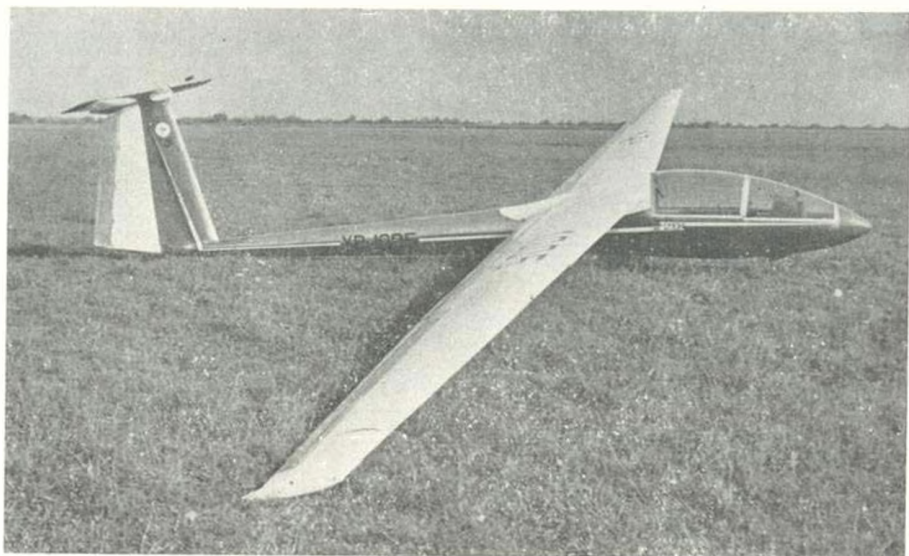

### I.S.-29 E (1971)

High-performance glider, unlimited class

Span 17.60 m, length 7.03 m, height 1.68 m, wing area 12.78 sq m, empty weight 275 kg, total weight 380 kg, lift-drag ratio 42 (at a speed of 92 km/h), maximum speed 220 km/h, minimum speed 65 km/h, sinking speed 0.50 m/s (at a speed of 92 km/h).

This is an improved variant of the *I.S.-29* series, adapted to the dominant meteorological conditions of Romania and Europe. It was designed by a team of *I.C.A.* of Braşov, headed by Eng. *Iosif Şilimon*. The wing and fuselage have the same structure as those of the *I.S.-29*. The wing profile is of the Wortman FX 61-163/124 type. The pilot's seat is comfortable during flight, and has a perfect visibility, the cabin having a jettisonable plexiglass cowling, with a lateral opening. The back of the seat is adjustable. The horizontal part of the tail unit is of the pendular type, aerodynamically and static trimmed by a balance weight located in the leading edge.

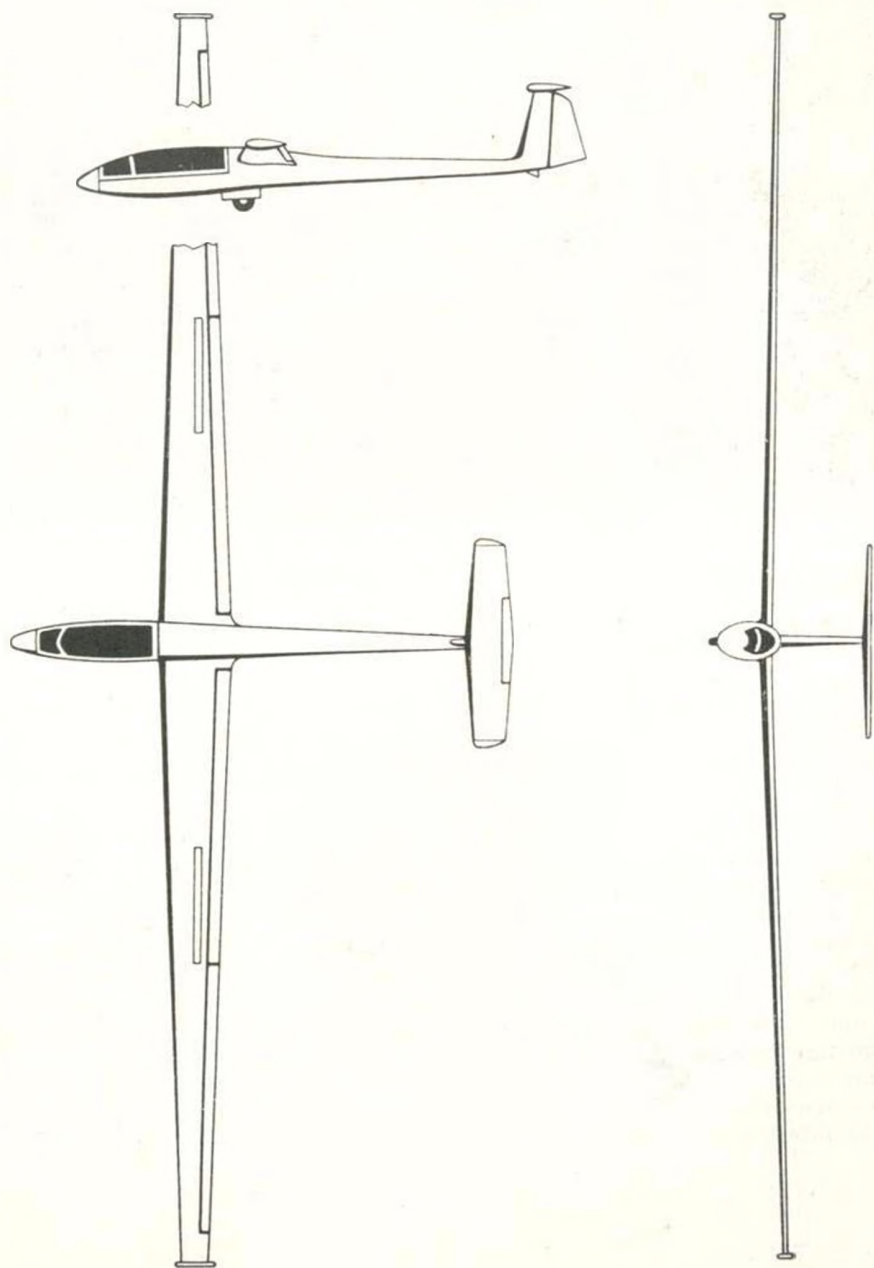

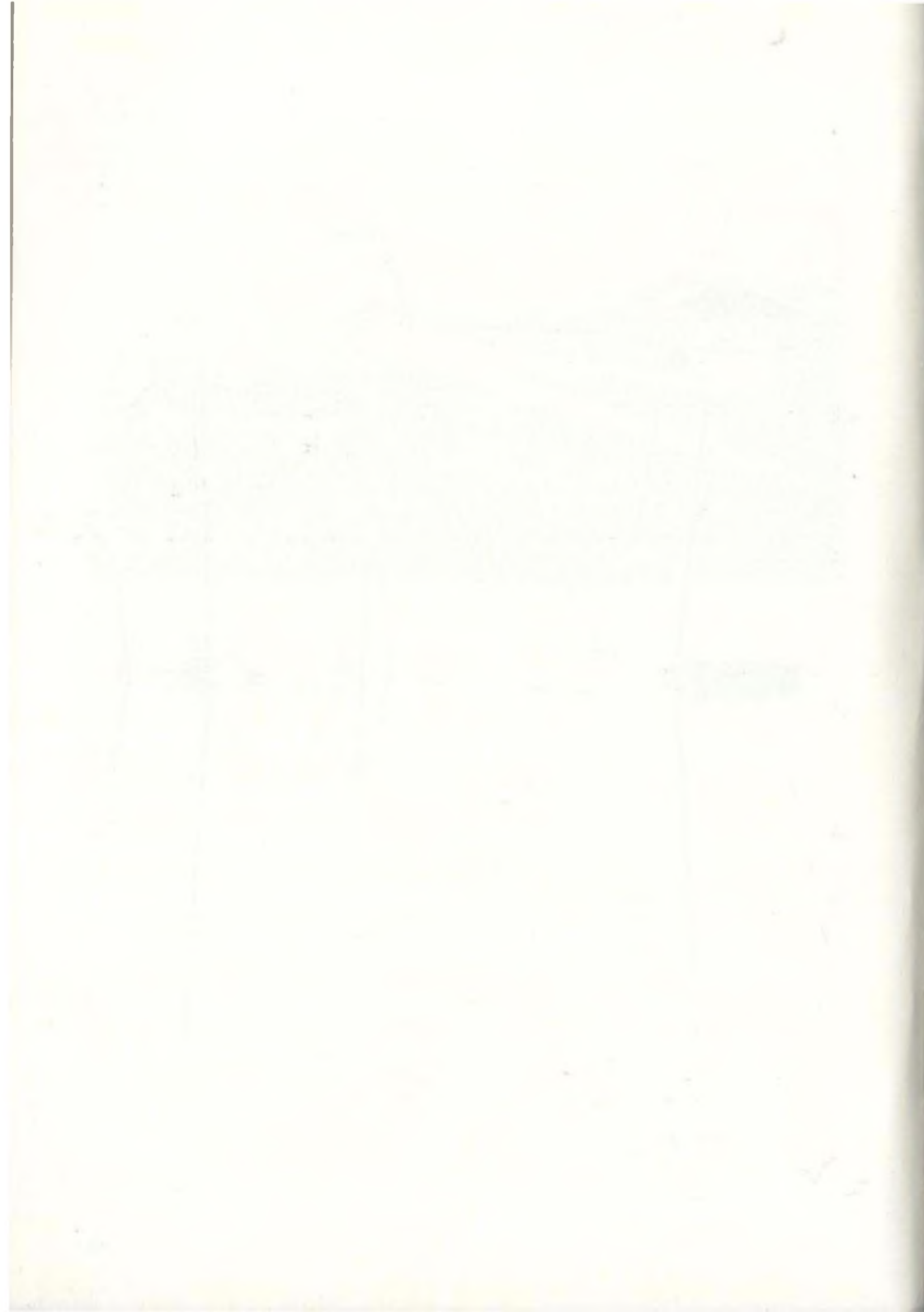



GROUND EFFECT  
—AIR CUSHION—  
MACHINES

---

THE UNIVERSITY OF CHICAGO

PHYSICS DEPARTMENT

PHYSICS 350

LECTURE 1

MECHANICS

1.1 Kinematics

1.2 Dynamics

1.3 Energy

1.4 Momentum

1.5 Angular Momentum

1.6 Oscillations

1.7 Relativity

1.8 Quantum Mechanics

1.9 Electromagnetism

1.10 Optics

1.11 Modern Physics

1.12 Miscellaneous

1.13 Appendix

## GROUND EFFECT—AIR CUSHION—MACHINES

Studies, research and tests made in Romania in the domain of ground effect (air cushion) machines coincided with those made for the first time in other countries. They started in 1959 at the *Institutul de mecanică aplicată al Academiei RSR (Applied Mechanics Institute of the Academy of the Socialist Republic of Romania)*, being initiated by a team headed by Eng. N.N. Patraulea, Corresponding Member of the Academy, and including engineers Gheorghe Rado and Ștefan Andrei.

In 1960 the team published in *Studii și Cercetări de Mecanică Aplicată*, a paper on the aerodynamic calculus of ground effect machines, the first Romanian theoretical study on the subject. The team continued its research systematically and also built several experimental vehicles. The designing, testing and building in Romania of G.E. Machines has also been the concern of teams of the *Institutul de cercetări și proiectări navale—ICEPRONAV (Shipbuilding Research and Design Institute)* and the *Politechnical Institute of Galați*, of the *Institutul pentru creație științifică și tehnică (Scientific and Technical Creation Institute)* and the *Întreprinderea de construcții aeronautice—I.C.A. (Aeronautical Constructions Enterprise)* of Brașov. Interesting results have also been obtained by the *Grupul de cercetări și experimentări navale—GCEXNAV (Shipbuilding Research and Experiment Group)* working under the auspices of the *Young Pioneers' House* of Galați.

The following pages present some of the GEM made by the above-mentioned teams.



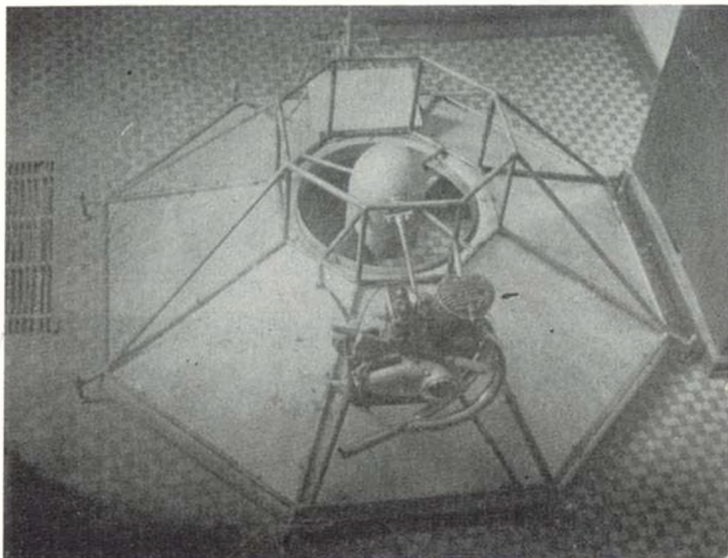

## R.-1 (1960)

### Experimental GEM

Diameter of the inner circle 2.1 m, base area 4 sq m, 11 HP IJ-350 cu cm motor cycle engine, axial fan (a two-bladed timber propeller of 680 mm diameter), empty weight 170 kg, total weight 240 kg.

This is the first GEM built in Romania. It was made at the *Applied Mechanics Institute of the Academy of the Socialist Republic of Romania*, under the supervision of Engineer *Gheorghe Rado*. The *R.-1* was a periphereal jet vehicle with integrated propulsion, the bottom having compartments for the stabilizing jets. The frame of the vehicle was made of steel pipes, and the cover of aluminium sheet. Inside, on the vehicle's bottom, were fixed 24 duraluminium radial surfaces which, simultaneously actioned by rudder control cables and deviating the periphereal jet, gave directional steer. Also, there were four flaps (forward, rearward, starboard, and port), all actioned with the column. By deflecting the corresponding flap, according to needs, one obtained horizontal forces on each of these directions. Of this first machine, a variant — named *R.-2* — has been derived, an experimental "plenum chamber" model with an empty weight of 150 kg. Both variants were used in a variety of tests regarding lift, stability and manoeuvrability, and also with a "thoroidal wing" conceived, following theoretical research, by Engineer *N.N. Patraulea*, Corresponding Member of the Academy.

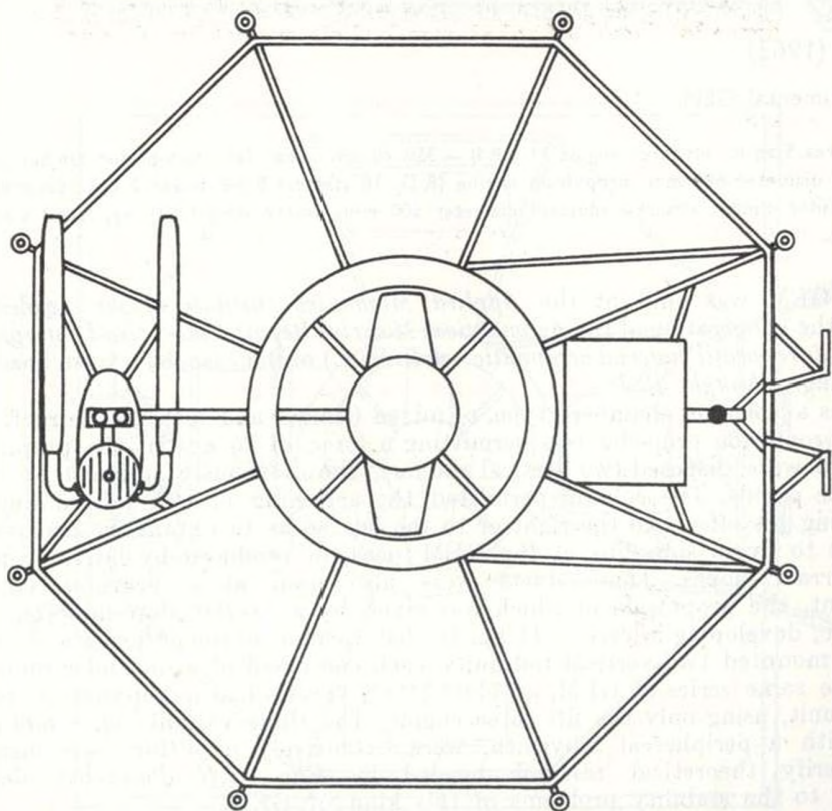
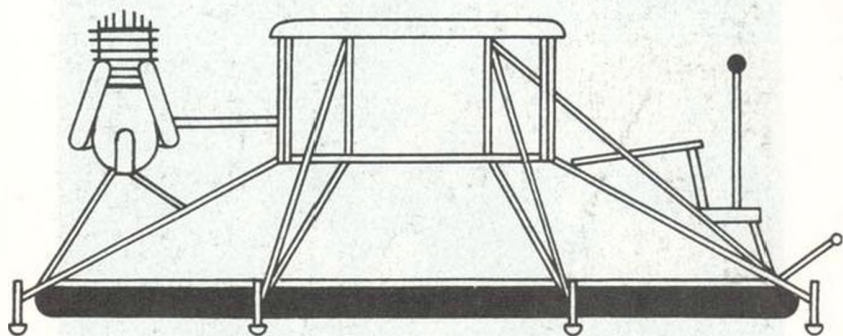

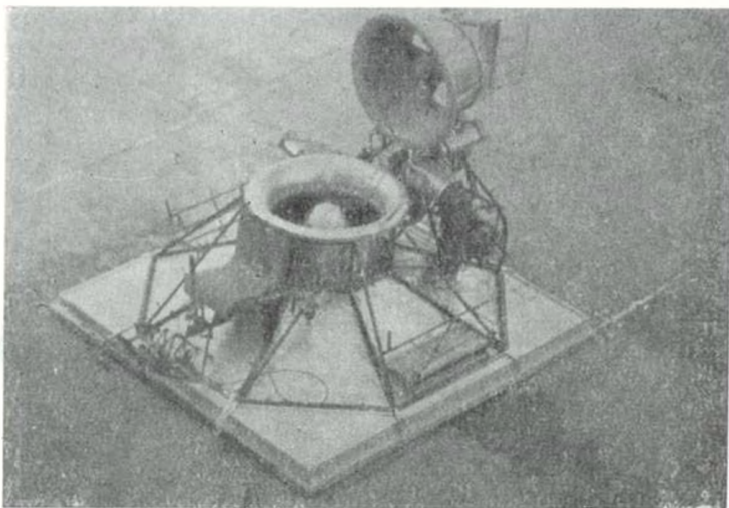

## R.-5 (1962)

### Experimental GEM

Base area 5 sq m, lift force engine 11 HP IJ — 350 cu cm, axial fan (two-bladed timber propeller) diameter 680 mm, propulsion engine (R.D. 10 starter) 8 HP boxer 2 cyl, propulsion four-bladed timber airscrew (ducted) diameter 600 mm, empty weight 235 kg, total weight 305 kg.

This GEM was built at the *Applied Mechanics Institute of the Academy*, with the cooperation of the *Aeronautical Material Repair Enterprise (Întreprinderea de reparații material aeronautic — I.R.M.A.)* of Băneasa, by a team headed by Eng. *Gheorghe Rado*.

It was a "plenum chamber" type, of mixed (timber and metal) construction. The propulsion propeller was permitting a force of 24 kg. In the propeller stream were disposed two vertical rudders, simultaneously actioned by the rudder pedals. The column permitted the actioning of two lateral ducts, creating jet effects to the right or to the left so as to obtain the necessary forces to avoid side-slips at the GEM turns, or produced by lateral winds or terrain slopes. These ducts were also used at a previous (*R.-4*) variant, the propulsion of which was given by a 2.6-HP Metrom-68 cu cm engine, developing a force of 11 kg. In that variant, in the propeller's stream were mounted two vertical tail units, each composed of a fin and a rudder. In the same series of GEM, an older (*R.-3*) variant had no separate propulsion unit, using only the lift force engine. The three variants (3, 4 and 5), all with a peripheral labyrinth, were extensively used for tests meant to verify theoretical research headed by Eng. *N.V. Patraulea*, dedicated to the stability problems of this kind of GEM.



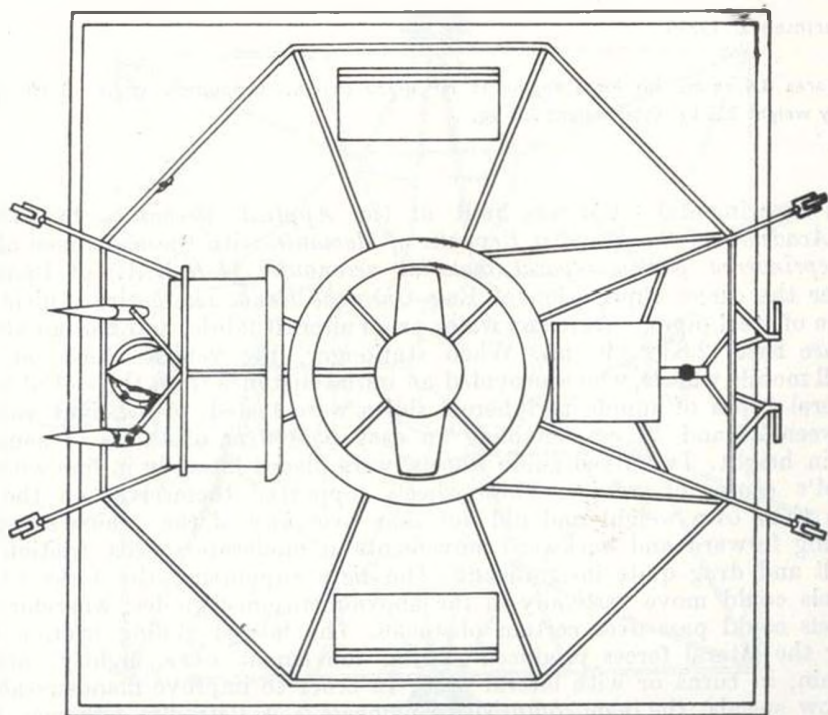
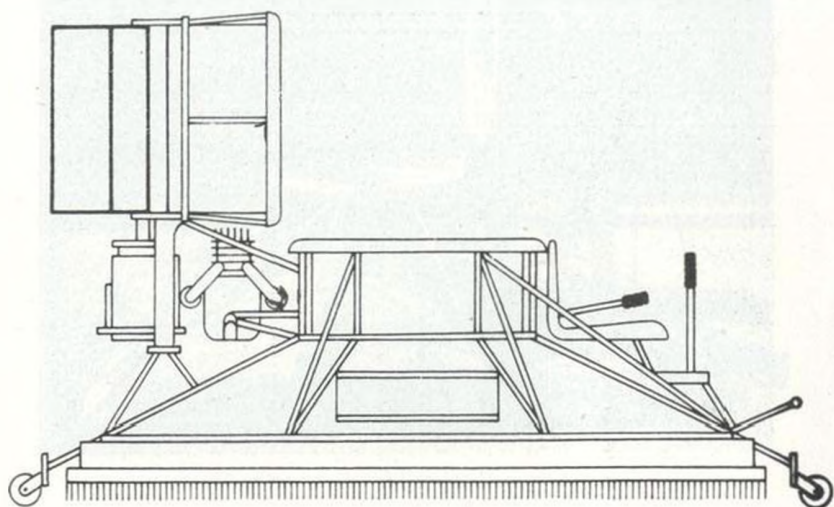

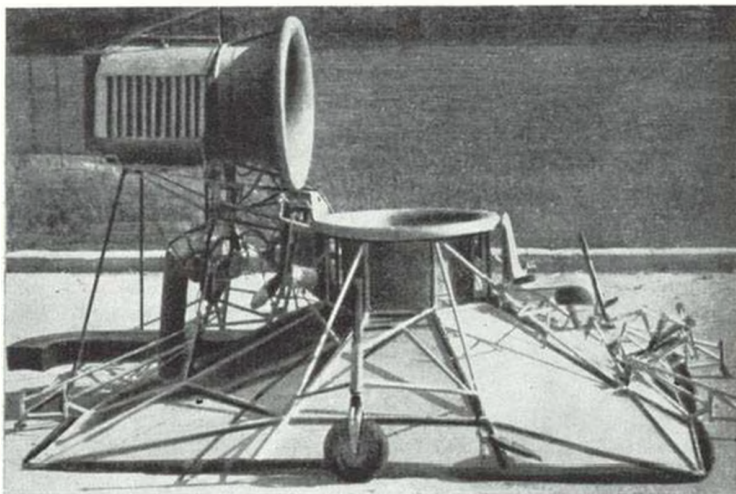

## R.-6 (1963)

### Experimental GEM

Base area 8.4 sq m, lift force engine 11 HP IJ-350 cu cm, propulsion engine 5 HP K-125, empty weight 225 kg, total weight 300 kg.

This experimental GEM was built at the *Applied Mechanics Institute of the Academy of the Socialist Republic of Romania* with the assistance of the *Intreprinderea pentru reparat material aeronautic (I.R.M.A.)* of Băneasa, under the direct supervision of Eng. *Gheorghe Rado*. The entire vehicle was made of steel pipes, covered by water-proof aircraft fabric, and had an almost square base (2.83×2.95 m). When stationary, the vehicle stood on four small mobile wheels, which provided an initial distance from the soil of 5 cm. Several types of supple peripheral skirts were tested, of a height varying between 25 and 28 cm, enabling an easy pass over obstacles of some 20 cm in height. Two fixed guide wheels were placed laterally in line with the GEM's centre of gravity. These wheels supported themselves on the soil with their own weight and did not take over any of the vehicle's weight. During forward and backward movements at moderate speeds, friction was small and drag quite insignificant. The bars supporting the forks of the wheels could move vertically in the above-mentioned guides, wherefore the wheels could pass over certain obstacles. The lateral gliding friction took over the lateral forces produced during movement over slightly inclined terrain, in turns or with lateral wind. In order to improve manoeuvrability at low speeds, the team comprising Engineers *N.N.Patraulea, Gheorghe Rado*

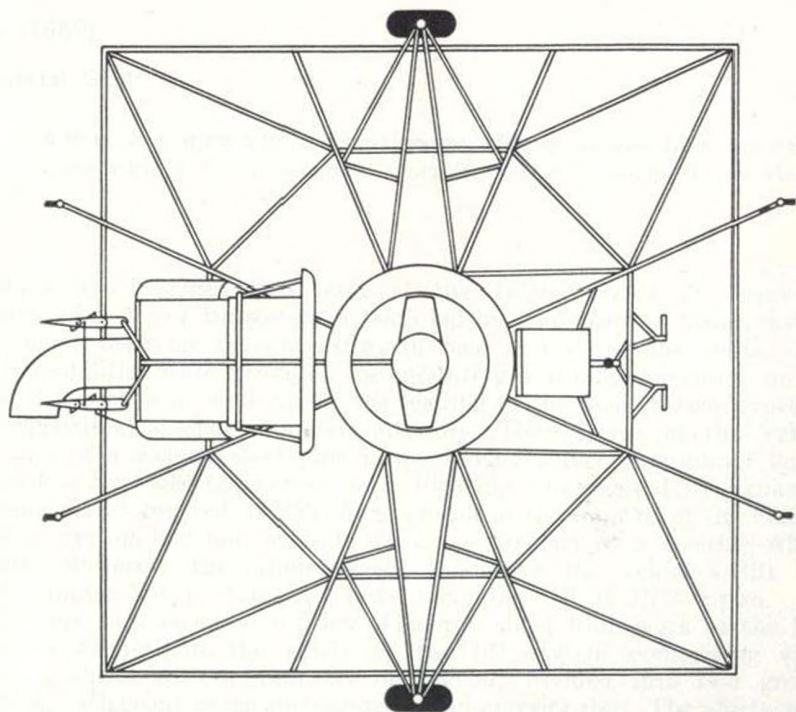
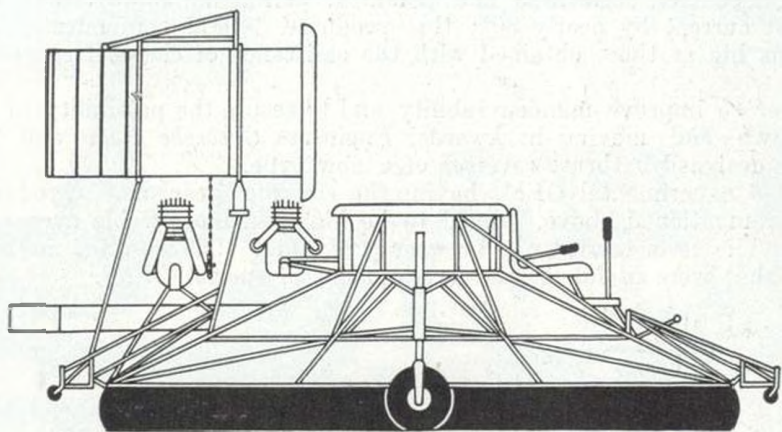



and *Ștefan Andrei* designed an altogether new type of control surfaces of direction control, segmented and trimmed, permitting a deviation of the incident current by nearly  $30^\circ$ ; this produced lateral components almost twice as big as those obtained with the assistance of classical control surfaces.

In order to improve manoeuvrability and to secure the possibility of slowing down and moving backwards, Engineers *Gheorghe Rado* and *Ștefan Andrei* designed a thrust reverser of a new type.

The *R-6* experimental GEM, having the steering gear and aerodynamic reverser mentioned above, proved to be highly manoeuvrable even at low speeds. The tests carried out between 1963 and 1966 resulted in experiments that were useful for the development of special GEMs.

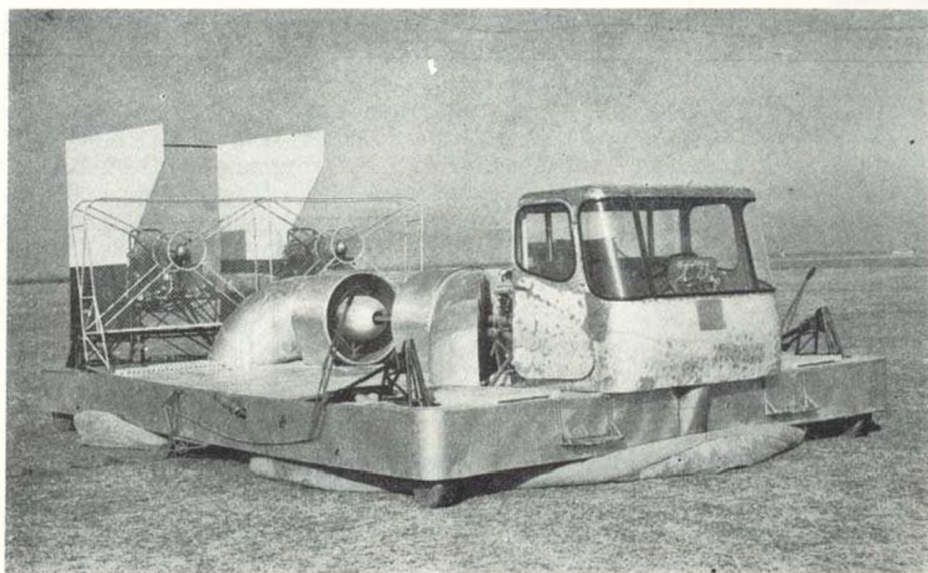

## I.S.-26 (1969)

### Experimental GEM

Total length 8.50 m, total width 5.00 m, empty weight 3,000 kg, payload 3,000 kg, opening between soil and skirts 5–7 cm, maximum speed 50–60 km/h, passage above obstacles cca 0.50 m.

The vehicle was designed and built at the *Întreprinderea de construcții aeronautice (I.C.A.)* of Brașov by a team led by Eng. *Iosif Șilimon*, with a view to being used for the harvesting of reed in the Danube Delta. That is why possibilities were provided for mounting a frontal harvester on the body of the vehicle as well as for the loading of the reed in two hydraulic tilted longitudinal shelves mounted laterally. The chassis of the vehicle was formed of a welded steel pipe frame having three longitudinal lattice girders linked by three transversal ribs. Floating was secured by expanded polystyrene plates covered in PVC foils, placed in the interior of the chassis. The rolling system had four aircraft wheels, controlled by a steering wheel. The engine powering the superchargers producing the vehicle's lift was an eight-cylinder V type S.R.-216, developing 193 HP at 3,750 r.p.m. The axial type fans faced each other. The iron sheet framework of the fans deviated the air jet into the skirts of the lift system comprising eight Bertin type skirts with a diameter of 1.88 m, divided into two groups of four each, each group being surrounded by an exterior skirt. The skirts were

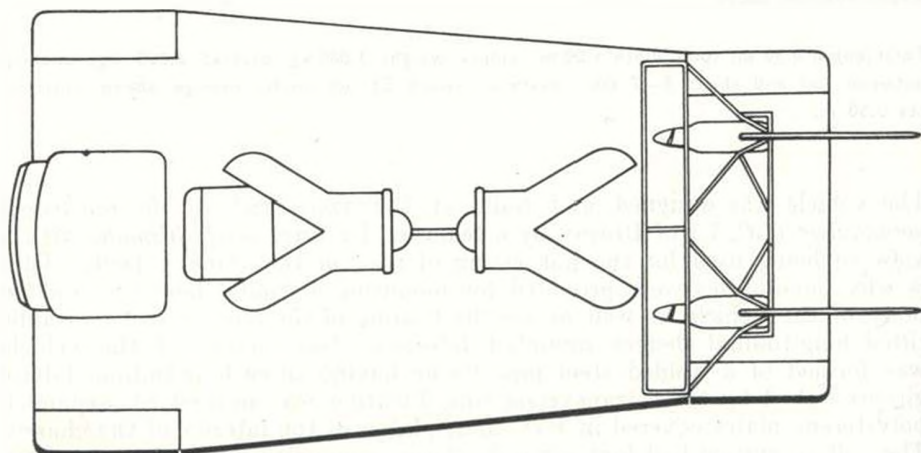
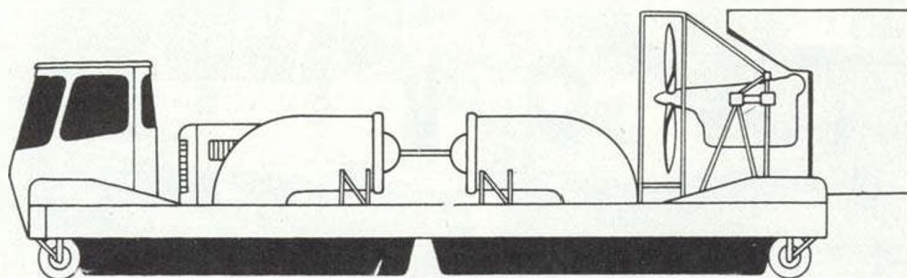



made of water-proof fabric and had a truncated cone shape with a deflection of 6°.

The stability of the vehicle was secured by a system of individual feed to the shirts, producing an automatic growth of the pressure on the shirt which had the smallest slope in relation to the soil. The propulsion of the *I.S.-26* GEM was provided by Walter Minor engines of 105 HP each at 2,500 r.p.m., provided with 2 m diameter propellers, each of them having a thrust of 284 kg at fixed point.

The *I.S.-26* experimental GEM was built for preliminary tests needed to obtain the data required for the designing of improved vehicles of this type.



### O.-1 (1969)

#### Experimental GEM

Length 2.80 m, width 1.63 m, cushion's area 4.5 sq m, empty weight 65 kg, total weight 110 kg.

This small GEM was designed and built by the *GCEXNAV* of the *Young Pioneers' House* of Galați, led by Eng. *Matei Kiraly*. The body of the vehicle is entirely made of timber, covered by aviation plywood, and the platform is covered by cloth.

Lift is provided by a *Druzhba* 4 HP 4,000 r.p.m. engine, which operates, with the assistance of an automatic clutch, a reductor and an axial fan with four blades, having a diameter of 600 mm. Propulsion is provided by a *UZ-2* 1.5 HP 5,000 r.p.m. engine which powers a two-blade airscrew with a diameter of 970 mm. Directional movements are actioned in motion with the assistance of an aerodynamic rudder placed in the propeller's stream.

The *O-1 Experimental* was successfully used in tests above land and water, with very good returns on land. It was driven by the youngest test pilot of the group, 14-year-old *Mircea Leonard*, who was specially trained for the purpose. During the tests a speed of 28 km/h was obtained above land, and of 15 km/h on water. Later on these performances were improved, and the GEM totalized 250 hours of travel. After public demonstrations in Galați and Bucharest, the *O-1 Experimental* was used to train the pilots of the group who would test future vehicles made by *GCEXNAV*.

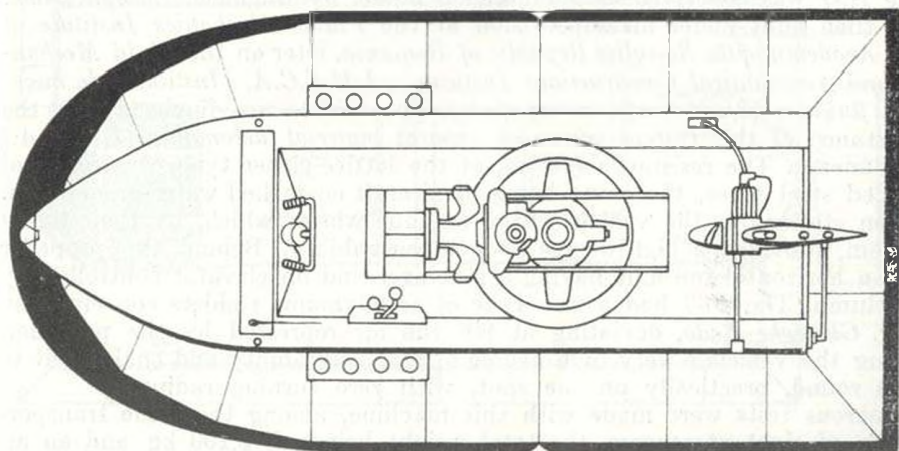
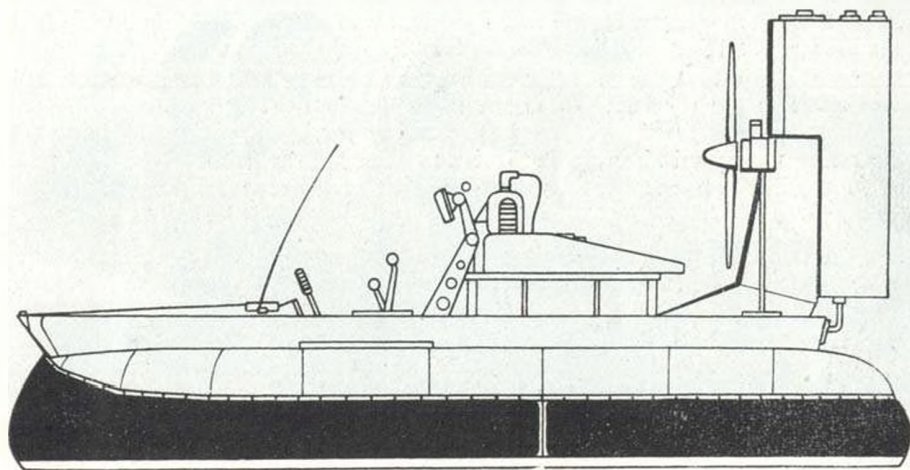



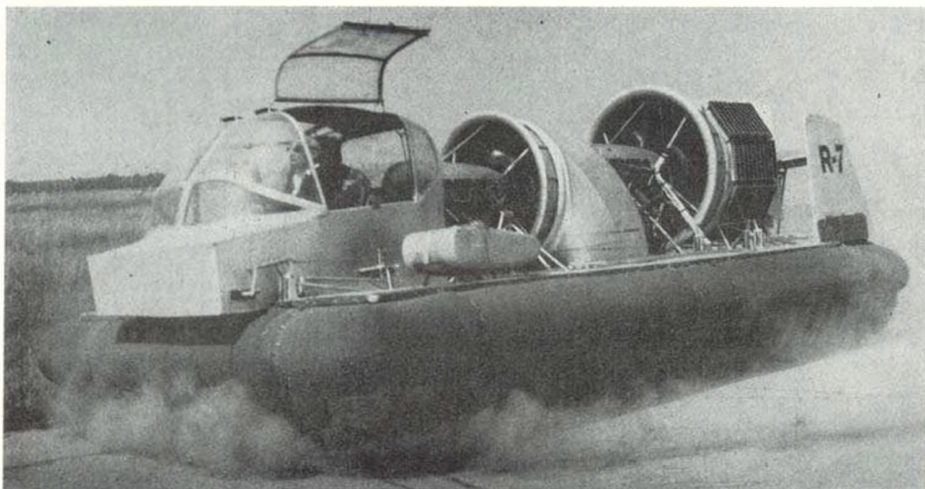

## R.-7 (1970)

### Experimental GEM







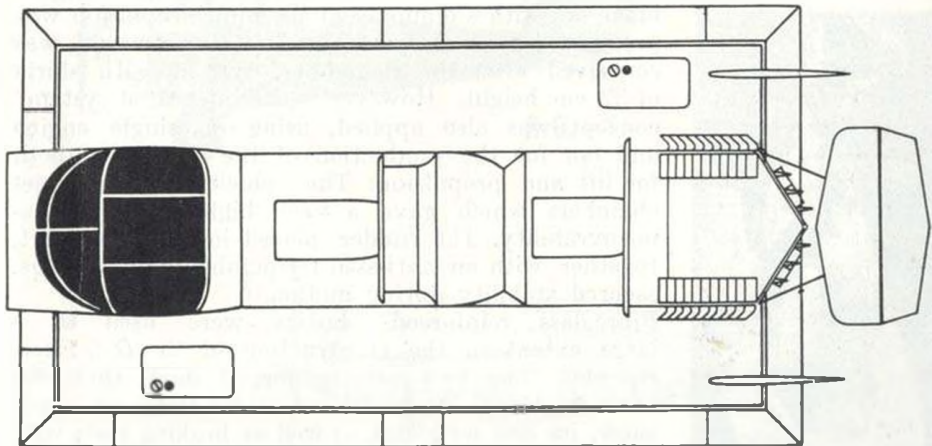
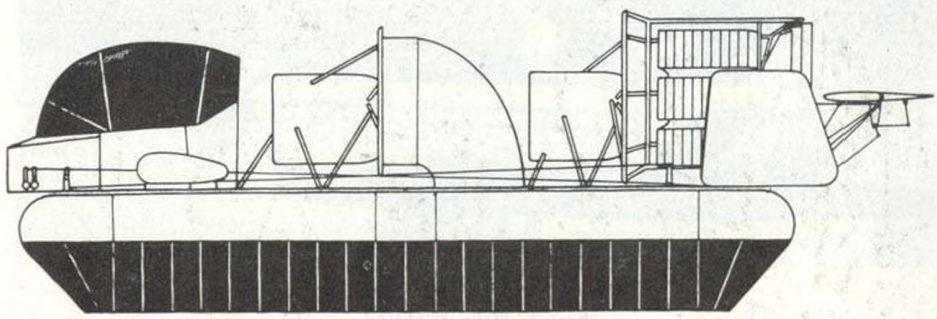

Total lifting surface 15.4 sq m, length of platform 6.04 m, height of platform 3.04 m, lift force engine WALTER MINOR 4-III of 105 HP at 2,500 r.p.m., propulsion engine WALTER MINOR 4-III of 105 HP, axial fan diameter 1.05 m, ducted airscrew diameter 1.30 m, empty weight 1,210 kg, total weight 1,950 kg (when carrying 5 persons plus 105 kg for centering).

The *R.-7* was conceived as a functional model by Engineer *Gheorghe Rado* and then built under his supervision at the *Fluids Mechanics Institute* of the *Academy of the Socialist Republic of Romania*, later on the *Fluid Mechanics and Aeronautical Constructions Institute—I.M.F.C.A. (Institutul de mecanica fluidelor și construcții aerospațiale)*. The vehicle was finalized with the assistance of the *Întreprinderea de reparat material aeronautic (I.R.M.A.)* of Băneasa. The resistance system, of the lattice-girder type, was made of welded steel pipes, the cover being of aircraft enamelled water-proof cloth. When stationary, the vehicle rested on four wheels which, by their fixing system, provided a high degree of manoeuvrability. Behind the propeller was a horizontal tail unit having a stabilizer and an elevator controlled by a column. The *R.-7* had a new type of aerodynamic rudders conceived by Eng. *Gheorghe Rado*, deviating at 60° the air repressed by the propeller, giving the vehicle a very high degree of manoeuvrability and enabling it to turn round, practically on the spot, with zero turning radius.



Numerous tests were made with this machine, among them the transportation of eight passengers, the total weight being of 2,100 kg and an air cushion pressure of 136 kg/sq m. As in the case of smaller payloads, manoeuvrability remained very good.



## MILITARY AIRCRAFT MARKINGS

<p>1912— 1941</p>	<p>on wings</p> 	<p>on tail</p> 
<p>1941— 1944</p>	<p>on wings and fuselage</p> 	<p>on tail</p> 
<p>1944— 1949</p>	<p>on wings and fuselage</p> 	<p>on tail</p> 
<p>since 1949</p>	<p>on wings</p> 	<p>on tail</p> 

## CIVILIAN AIRCRAFT MARKINGS

<p>1928— 1933</p>	<p>on wings and fuselage</p> <p><b>CV-ABO</b></p>	
<p>since 1933</p>	<p>on wings and fuselage</p> <p><b>YR-ACS</b></p>	<p>on tail</p> 
<p>since 1953 for gliders</p>	<p>on wings and fuselage</p> <p><b>YR-974</b></p>	<p>on tail</p> 



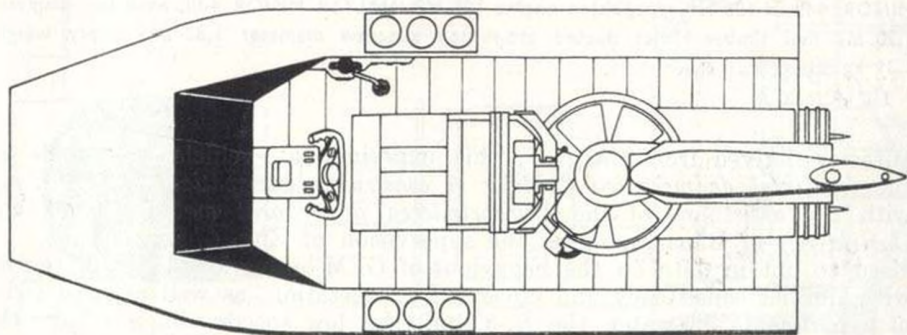
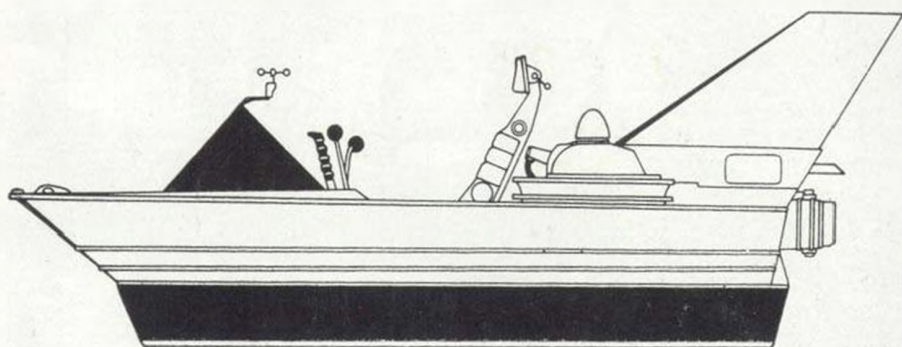



## O.-9 (1970)

### Experimental GEM

Length 2.77 m, width 1.05 m, area of the air cushion 1.7 sq m, empty weight 45 kg, total weight 100 kg.

The vehicle was designed and built by the *GCEXNAV* of the *Young Pioneers' House* at Galați.

Actually two vehicles were built. They had a Mobra scooter engine of 4 HP at 7,000 r.p.m. made at Brașov, powering an eight-blade fan with a diameter of 400 mm. Propulsion was provided by an air jet. The *O.-9-Experimental* was conceived after the "chamber" system, with shirts of 32 cm height. However, an "integrated system" concept was also applied, using a single engine and fan for the production of the air needed both for lift and propulsion. The vehicle had three jet chambers which gave a very high degree of manoeuvrability. The rudder, placed in the rear part, together with an anti-skid retractable undercarriage, secured stability during motion.



Fibreglass reinforced plastics were used to a large extent in the construction of the *O.-9-Experimental*. The two vehicles logged more than 300 hours of travel in special conditions (tests on sand, snow, ice and icefloats), as well as braking tests with the assistance of parachutes. When the tests required bigger speeds than the 18 km/h recorded initially, experiments were made on inclined terrain, where a top speed of 87 km/h was reached.

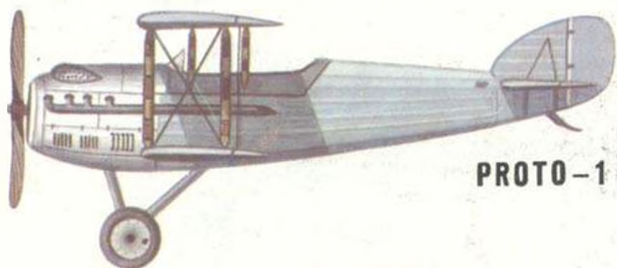

**PROTO-1**

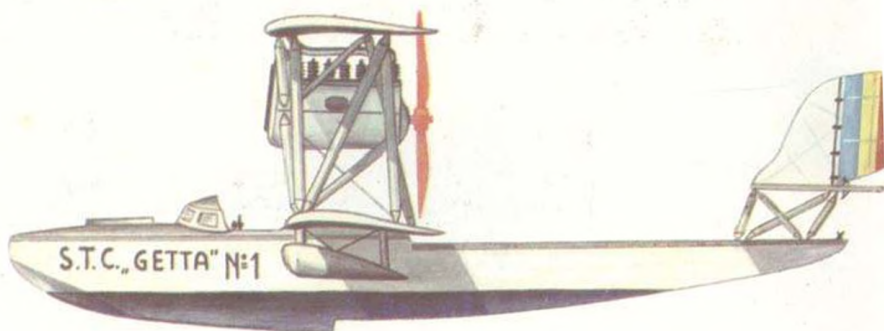

**R.A.S. - 1 „GETTA“**

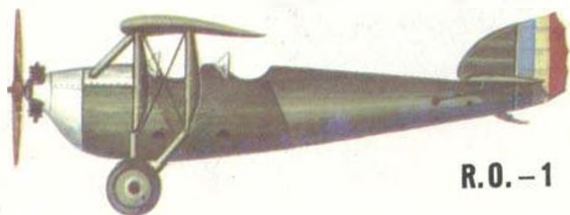

**R.O. - 1**

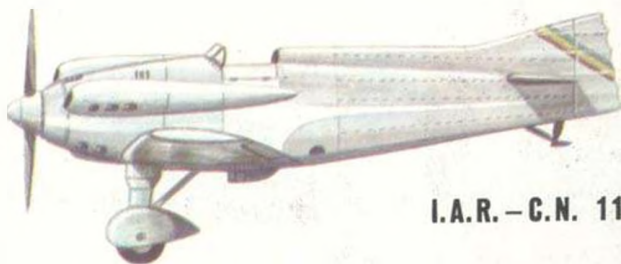

**I.A.R. - C.N. 11**





## R.-8 (1971)

### Experimental GEM

Length 7.31 m, width (with inflated skirts) 3.67 m, height 3.03 m, lift force engine WALTER MINOR 4-III of 105 HP, propulsion engine 105 HP WALTER MINOR 4-III, axial fan diameter 1.20 m, four timber blades ducted propulsion airscrew diameter 1.82 m, empty weight 1.31 kg.

Directly derived from the *R.-7*, this experimental vehicle was made at the *Institutul de mecanica fluidelor și construcții aerospațiale (I.M.F.C.A.)* with the assistance of the *Întreprinderea de reparat material aeronautic (I.R.M.A.)* of Băneasa, under the supervision of Eng. *Gheorghge Rado*. Used to obtain data on the behaviour of GEM on various types of terrain with limited consistency and covered by vegetation, as well as in a series of experiments on water, the *R.-8*, built for low speeds, did not have the horizontal tail unit characteristic of the *R.-7*.

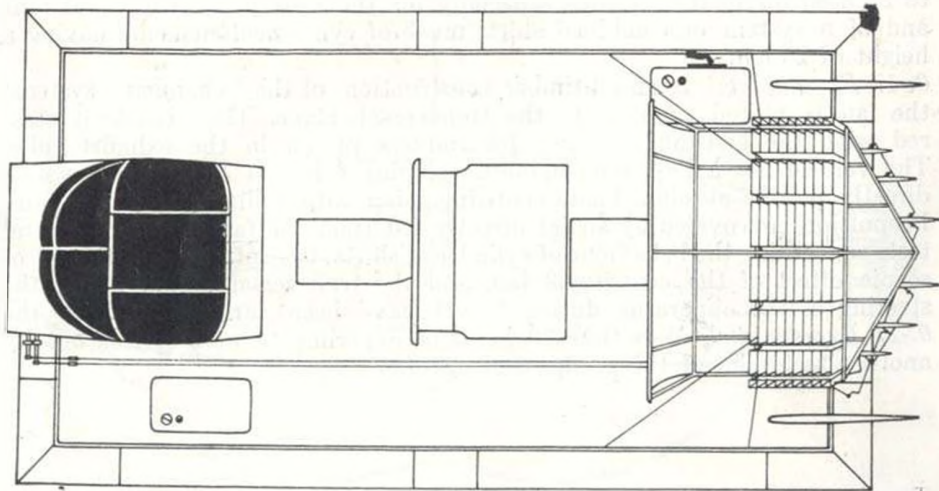
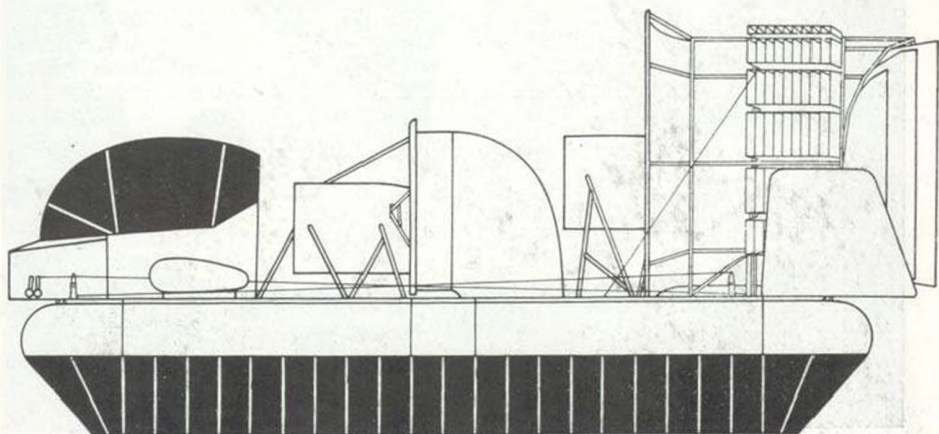

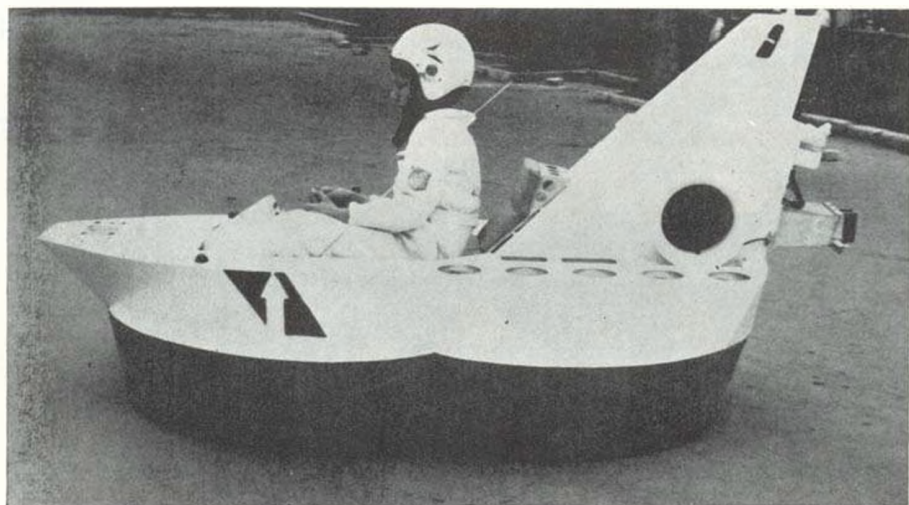

### O.-17 (1971)

Experimental GEM

Length 2.29 m, width 1.26 m, total weight (with pilot) 85 kg.

This GEM was designed and built by the team of the *GCEXNAV* of Galați to be used for further studies, especially for the testing of centrifugal fans and of a system of combined shirts made of cylindrical elements having a height of 25 cm.

*O.-17 Experimental* is an all-timber construction of the "chamber" system; the fan is placed parallel to the transversal plane. The vehicle is steered with the assistance of two jet rudders placed in the exhaust tube. The vehicle has a Druzhba engine developing 4 HP at 4,000 r.p.m. which directly powers an eight-blade centrifugal fan with a diameter of 385 mm. Propulsion is provided by air jet directly fed from the fan's effuser. Several tests concerning the behaviour of cylindrical shirts, the influence of the gyroscopic effect of the centrifugal fan, and the transversal stability and the steering of the apparatus during travel have been carried out with the *O.-17 Experimental*. More than 30 hours of experiments were carried out by another test pilot of the group, *Sorin Zosim*.



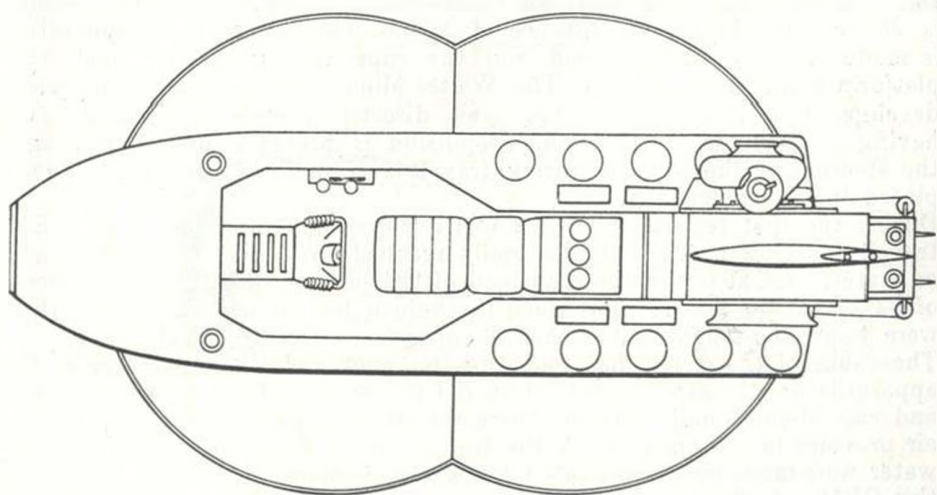
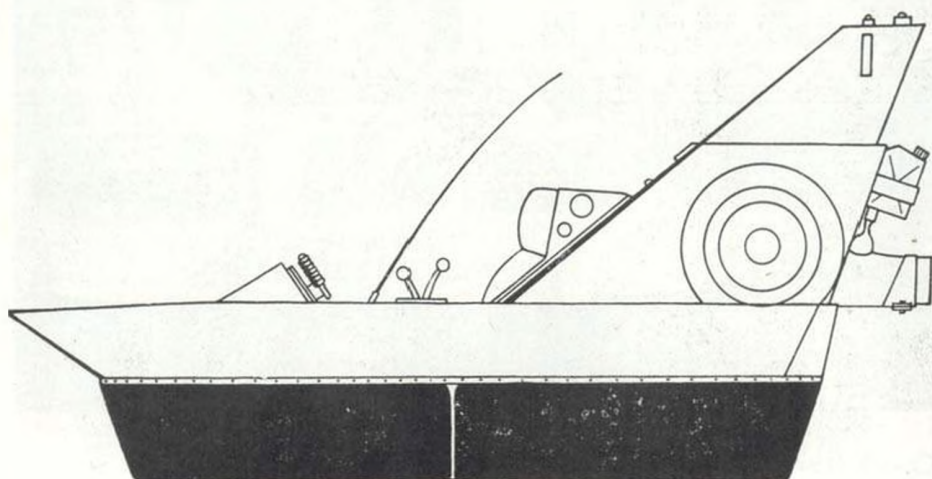



## O.-20 (1972)

### Experimental GEM

Length 4.950 m, width 2.570 m, lifting area 10.00 m, empty weight 360 kg, payload (4 persons plus 100 kg fuel) 400 kg, total weight 760 kg.

This is the first large-size vehicle designed and built by the *Naval Research and Experiments Group* of the *Young Pioneers' House* of Galați. Conceived after the "chamber" system, the *O.-20E* had extendable peripheral skirts and a longitudinal skirt for transversal stability. The skirts' height is 28 cm, securing a soil distance of 25 cm. The frame of the apparatus is made of pinewood, the bead and the superstructure of plywood, the platform being cloth covered. The Walter Minor 4-III type aircraft engine develops 105 HP at 2,800 r.p.m. and directly powers a six-blade fan having a diameter of 970 mm. Propulsion is provided by air jet, and the steering of the vehicle during travel is secured by five jet rudders placed in the exhaust tube.

During the first tests on the *AVIASAN* aerodrome of Galați, the GEM travelled at low speed, but eventually reached 75 km/h. Next came tests on water, carried out in the roadstead of the port of Galați, where a speed of 82 km/h was reached, but when the vehicle had to negotiate waves that were twice the height of the skirt, its operation became unsafe.

The cabin of the *O.-20E* has room for the pilot and three passengers. Its apparatus are the same as that of an *I.A.R.-818* aircraft (less the altimeter and rate-of-climb indicator) and there are also two gauges for the control of air pressure in the cushion. All the tests with the *O.-20* on dry land and on water were made by the group's pilot *Mircea Leonard*. This vehicle, like all the GEMs of the *O.-Experimental* series, was built under the supervision of Eng. *Matei Kiraly*.

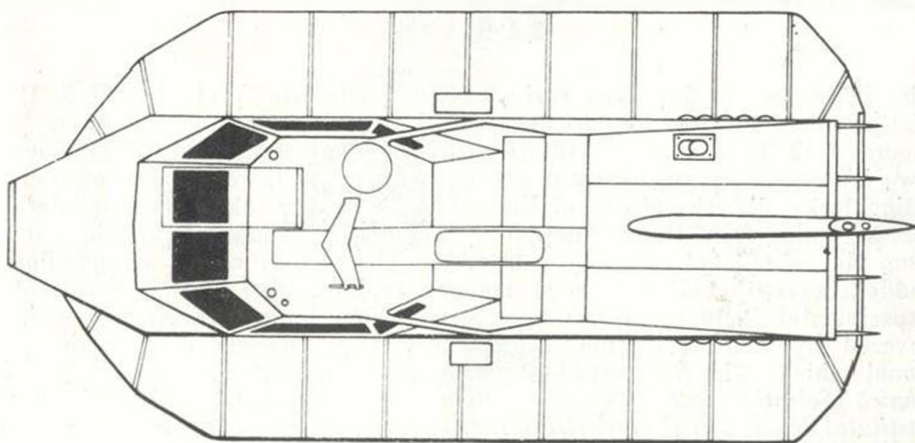
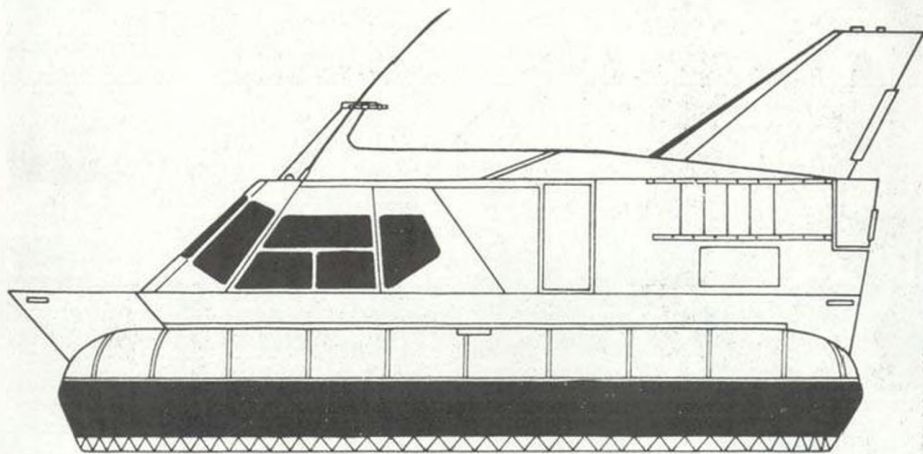



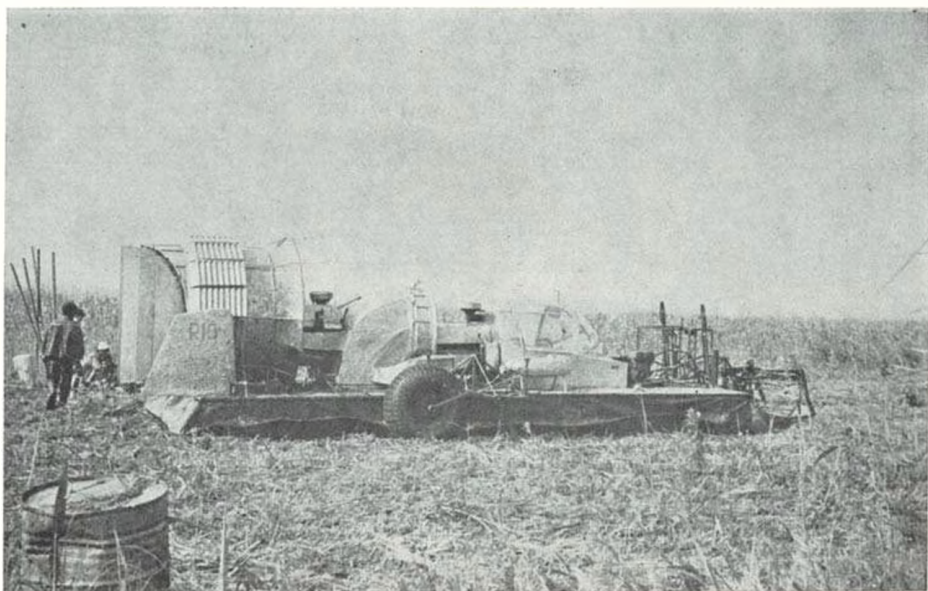

## R.-10 (1972)

### Experimental GEM

Length 10.62 m, width 4.97 m, height 3.03 m, lift force engine M-337 of 170 HP, propulsion engine M-337 of 170 HP at 2,600 r.p.m., axial ventilator diameter 1.30 m, ducted propulsion airscrew diameter 1.82 m, total weight 2,210 kg.

The *R.-10* was an improved variant of its predecessor prototype *R.-9*. Its platform had the frontal part lengthened by some two metres, so as to mount a 12-HP engine powering a hydraulic pump and a harvesting device. Two big wheels, permanently in contact with the soil, were placed on oscillating forks near the centre of the vehicle, so as to take over the lateral forces coming from the inclination of the terrain, from lateral wind and from the centrifugal forces born at turns. The high efficiency aerodynamic rudders gave the GEM a good manoeuvrability. Like the *R.-9* variant, experimental *R.-10 GEM* was used in tests on limited consistency soils, covered by rich vegetation, soils which were inaccessible to conventional vehicles. The *R.-10* was built at the *Institutul pentru creație științifică și tehnică* (Scientific and Technical Creation Institute) in collaboration with the *Institutul de cercetări și proiectări al Deltei Dunării, Secția de mecanizare Maliuc* (Maliuc Mechanization Section of the Danube Delta Research and Design Institute) and *I.R.M.A.* of Băneasa, under the supervision of Eng. *Gheorghe Rado*.

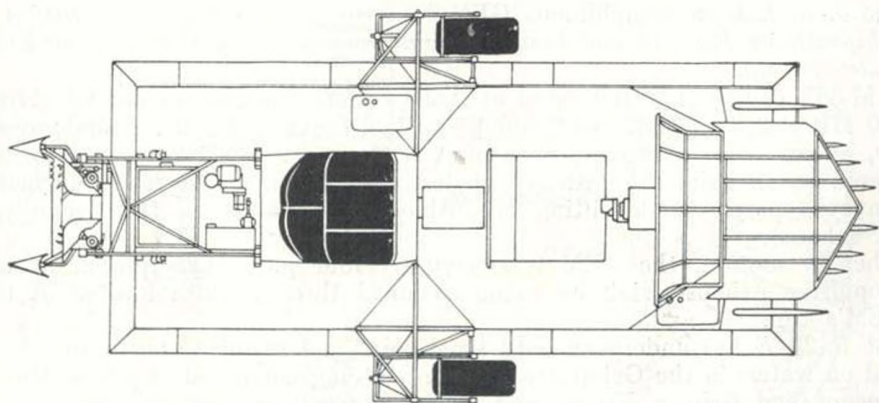
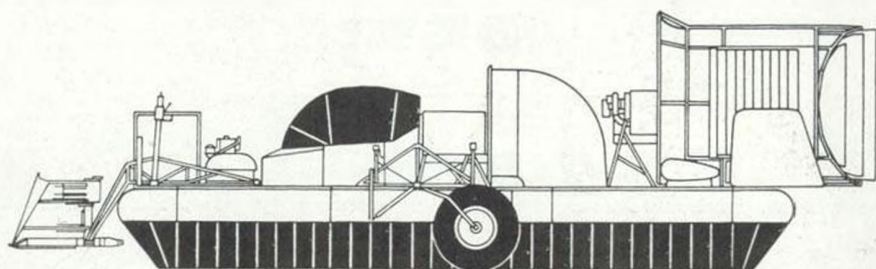

## TECHNICAL DATA OF

### I. AIRPLANES

No.	Type of aeroplane	Category	Year of construction	Dimension (in)	
				span	length
1	2	3	4	5	6
1	VUIA No. 1	—	1905	7.00	3.20
2	VUIA No. 2	—	1907	7.90	—
3	VLAICU No. I	—	1910	10.00	12.00
4	COANDĂ-1910	—	1910	10.30	12.50
5	COLUMBA	—	1911	(No exact	
6	VLAICU No. II	—	1911	10.00	11.20
7	N. SARU-IONESCU	—	1911	(Except the	
8	LĂCUSTA	—	1911	9.20	8.35
9	ION PAULAT	—	1912	13.00	9.20
10	VLAICU No. III	—	1914	10.00	10.75
11	PROTO-1	advanced training	1922	9.60	7.00
12	ASTRA-ŞEŞEFSKI	reconnaissance	1923	12.60	8.62
13	PROTO-2	primary and advanced training	1924	9.60	7.00
14	ASTRA-PROTO	reconnaissance	1925	10.60	7.20
15	RA.BO.	primary training	1926	10.00	6.12
16	PROTO-S.E.T. 2	reconnaissance	1927	13.40	8.60
17	MORANE-SAULNIER M.S.35	training	1928	10.57	6.77
18	S.E.T.-3	training	1929	9.80	7.20
19	POTEZ-XXV	reconnaissance-bomber	1929	14.02	9.20
20	I.A.R.-C.V.11	fighter	1930	11.50	6.98
21	S.E.T.-31	training and liaison	1930	9.80	7.20
22	R.O.-1	primary training	1930	12.00	6.12
23	S.E.T.-7	advanced training	1930	9.80	7.30
24	CRUISAIRE	aerobatics and touring	1930	7.26	—
25	S.E.T.-4	training	1931	9.80	—
26	S.E.T.-41	blind flying training	1932	9.80	—
27	I.C.A.R.-M. 23b	primary training and touring	1932	11.50	6.50
28	S.E.T.-31 G	touring	1932	9.80	7.20
29	S.E.T.-10	primary training	1932	9.46	7.30
30	R.M.-4	touring	1932	8.00	8.30
31	S.E.T.-X	advanced training	1932	8.70	7.30
32	BRATU-220	commercial airliner	1932	25.00	17.47
33	I.A.R.-14	fighter	1933	11.70	7.32
34	FILIP MIHAIL STABILOPLAN	sport and touring	1933	9.00	3.70
35	I.A.R.-15	fighter	1933	11.00	8.29
36	I.A.R.-21	primary training	1933	12.00	7.00
37	I.C.A.R.-Universal	training and touring	1934	11.85	6.75
38	I.A.R.-16	fighter	1934	11.70	7.37
39	S.E.T.-XV	fighter	1934	9.40	7.00
40	I.C.A.R.-Comercial	commercial airliner	1934	15.40	9.80
41	S.E.T.-7 K	observation	1934	9.80	7.72
42	I.A.R.-23	long-range touring	1934	12.00	8.35
43	I.C.A.R.-Universal	aerobatics	1934	12.90	6.75



# ROMANIAN AIRCRAFT

Dimensions (in)	Weight (in kg)		Power plant		Performance		P.	
	height	empty	total	type	power (in HP)	maximum speed (km/h)		ceiling (in m)
		8	9					
—	—	241	Serpollet (modified)	20	—	—	68	
—	—	213	Antoinette	24	—	—	72	
4.22	—	300	Gnome (rotary)	50	—	—	74	
—	—	420	original reactive compound	220 kg	—	—	78	
data known, excepting			the Gnome	50	—	—	83	
4.20	—	300	Gnome (rotary)	50	110	—	85	
drawings, no data are			available on this aircraft)	—	—	—	89	
3.20	—	—	—	—	—	—	91	
—	—	250	?	50	—	—	93	
3.10	—	—	Gnome	80	144	—	94	
2.90	670	1,080	Hispano-Suiza	180	183	6,000	96	
3.12	1,120	1,620	Martha-Benz	250	185	5,500	98	
2.90	730	1,140	Hispano-Suiza	180	174	5,000	100	
2.90	1,010	1,488	Hispano-Suiza	300	205	5,500	102	
2.60	525	735	Rhone (rotary)	80	145	—	106	
3.40	1,220	2,020	Lorraine-Dietrich	450	222	7,000	108	
3.61	450	700	Gnome-Rhone (rotary)	80	135	4,600	110	
3.15	826	1,120	Salmson 9 Ab	230	215	—	112	
—	1,370	1,960	Lorraine-Dietrich	450	217	7,400	114	
2.46	1,100	1,510	Lorraine-Courlis	600	329	9,000	116	
3.15	826	1,120	Salmson 9 Ab	230	215	6,000	118	
2.20	360	550	Anzani	35	125	—	120	
3.15	912	1,310	Jaguar	365	240	6,200	122	
—	397	600	Rover	75	136	—	124	
—	812	1,200	Salmson 9 Ab	230	210	5,000	127	
—	868	1,322	Gnome-Rhone	380	202	5,000	127	
2.00	375	700	Siemens-Halske SH 13 b	80	170	3,800	129	
3.15	968	1,350	Lorraine-Mizar 47 a	240	210	6,500	132	
2.73	548	800	Gipsy Major	130	180	5,500	134	
—	175	250	Indian	12	85	—	136	
—	890	1,184	Jaguar	365	260	8,000	138	
6.55	4,400	9,000	Gnome-Rhone Titan and one Jupiter	2 × 230 420	200	—	140	
2.50	1,150	1,540	Lorraine-Dietrich	450	293	7,500	142	
2.00	241	381	Scorpion ABC II	35	147	4,000	144	
2.70	1,368	1,707	Gnome-Rhone 9 Krsd	600	352	10,000	146	
2.50	580	850	Walter	120	190	5,500	148	
2.50	450	825	Siemens-Halske SH 14 a	150	180	4,000	150	
2.80	1,224	1,650	Bristol Mercury IV S 2	500	342	10,000	152	
3.05	1,150	1,550	Gnome-Rhone 9 Krsd	500	235	9,400	154	
2.80	1,320	2,250	Armstrong-Siddeley Serval Mark 1	340	325	4,500	156	
3.26	1,010	1,650	Gnome-Rhone 7 Krsd	380	320	7,000	158	
2.70	980	1,920	Hispano-Suiza 9 Qa	340	245	4,100	160	
2.50	450	698	Siemens-Halske SH 14 a	150	180	—	162	

1	2	3	4	5	6
44	AERON	basic training	1934	9.80	6.45
45	I.A.R.-22	training and touring	1934	11.53	7.50
46	P.Z.L.-11 F	fighter	1934	10.72	7.56
47	I.C.A.R.-Universal	training and touring	1934	11.90	6.90
48	R.M.-5	touring	1935	8.00	5.60
49	I.C.A.R.-Acrobatic	aerobatic training	1935	8.40	8.50
50	I.A.R.-24	long-range touring	1935	12.00	8.35
51	R.M.-7	light touring	1935	5.00	4.00
52	S.E.T.-7 KB and S.E.T.-7 KD	tactical reconnaissance and liaison	1935	9.80	7.15
53	FLEET-F 10 G	primary and basic training and liaison	1936	8.53	7.29
54	R.O.-2	basic training and touring	1936	10.96	6.68
55	I.A.R.-27	basic training	1937	9.10	7.41
56	P.Z.L.-24 E	fighter	1937	10.71	7.50
57	I.C.A.R.-Turing	touring	1937	10.50	6.40
58	I.A.R.-37	reconnaissance and light bombing	1937	12.22	9.50
59	I.A.R.-38	reconnaissance and light bombing	1938	13.20	9.56
60	G.M.-1	light touring	1939	10.00	6.30
61	IASI-1	light touring	1939	9.82	6.20
62	NARDI FN-305	advanced training	1939	8.476	7.136
63	I.A.R.-39	reconnaissance and light bombing	1939	13.10	9.60
64	I.A.R.-80	fighter and dive-bomber	1939	10.50	8.90
65	JR.S.-79B SAVOIA MARCHETTI	medium-to-heavy bomber and reconnaissance	1940	21.20	16.82
66	R.M.-9	sports and touring	1942	7.50	5.50
67	FIESLER Fi-156 Storch	light multi-purpose	1942	14.25	9.75
68	MESSERSCHMITT Me-109 G	fighter	1944	9.92	8.85
69	R.M.-11	touring	1944	7.50	5.80
60	I.A.R.-811	sports and training	1949	10.40	8.25
61	I.A.R.-813	training and aerobatics	1950	10.00	8.35
72	I.A.R.-814	training, ambulance and light transport	1953	14.00	11.05
73	R.M.-12	experimental	1953	6.00	4.70
74	I.A.R.-817	utility	1955	12.60	9.80
75	M.R.-2	light transport	1956	14.00	10.90
76	Y.A.K.-23 D.C.	basic and advanced training	1956	8.10	7.01
77	R.G.-6	training	1957	10.50	7.50
78	R.G.-7 Soim	training and touring	1958	9.90	7.85
79	R.G.-7 Soim III	training and aerobatics	1959	9.50	7.85
80	I.A.R.-818	utility	1960	12.10	9.90
81	I.A.R.-821	utility	1967	12.80	9.20
82	I.A.R.-821 B	primary and basic training	1968	12.80	9.20
83	I.S.-23 A	utility	1969	12.40	9.10
84	B.N.-2 Islander	light transport	1969	14.92	10.90
85	I.A.R.-822	agricultural	1970	12.80	9.40
86	I.A.R.-824	utility	1971	12.40	9.20
87	I.A.R.-822 B	training	1973	12.80	9.40
88	I.A.R.-823	multi-purpose	1973	10.00	8.24

7	8	9	10	11	12	13	14
2.45	760	1,010	Salmson 9 Ac	120	187	4,200	164
2.02	647	880	D. H. Gipsy Major	130	193	5,000	166
2.90	1,108	1,590	I.A.R. K 9	600	300	10,000	168
1.95	465	710	D. H. Gipsy Major	130	195	5,500	170
—	120	200	Anzani	30	120	—	174
2.60	—	—	Siddeley Linx Mk 4	225	215	—	176
2.70	1,180	2,030	Gnôme-Rhône	350	280	4,500	173
—	145	240	Poinsard	20	135	3,000	180
3.26	1,115	1,780	I.A.R. K 7-120	420	250	5,500	182
2.50	530	780	I.A.R.-Gipsy Major 4	130	185	3,000	184
2.30	463	740	Siemens-Halske SH 13	80	165	4,500	186
2.40	670	948	I.A.R.-6 G1	180	180	5,000	190
2.96	1,270	1,775	I.A.R.-K14	870	430	10,500	192
1.91	378	600	Pobjoy-Niagara	90	182	3,000	194
3.97	2,219	3,060	I.A.R.-K14	870	335	8,000	196
3.80	2,300	3,100	B.M.W. 132	700	—	7,000	198
2.50	450	610	Salmson	40	123	3,500	200
—	205	365	Salmson	40	150	4,000	202
2.15	700	858	I.A.R. 6 G1	180	300	—	204
3.99	2,177	3,085	I.A.R.-K14-IV C 32	870	336	8,000	206
3.60	1,780	2,550	I.A.R. K14-1000 A	1,000	510	10,500	208
5.55	7,000	12,000	Junkers Juno 211 Da	2 × 1,200	425	7,700	212
—	255	350	Praga	32	138	—	214
3.76	930	1,326	Argus As 10 C	240	175	5,090	216
3.20	—	3,400	Daimler-Benz, A-1	1,475	615	11,800	218
—	303	530	Train	60	175	4,000	220
2.20	420	650	Train	60	150	3,700	222
2.25	498	750	Walter Minor	105	192	5,800	224
2.92	1,400	2,030	Walter Minor 6 III	2 × 160	272	5,600	226
2.60	132	230	2 cylinders	20	125	2,500	228
3.40	800	1,150	Walter Minor 6 III	160	175	3,000	230
2.76	1,415	2,080	Walter Minor 6 III	2 × 160	275	4,900	232
3.30	—	3,405	R.D.-500	1,600kgf	890	12,000	234
2.62	400	650	Praga-D	75	190	4,800	236
2.67	520	750	Walter Minor 4 III	105	215	5,000	238
2.67	482	640	Walter Minor 4 III	105	251	5,300	240
3.30	805	1,300	Walter M 337	170	185	4,000	242
2.80	1,080	1,900	A.I.-14 R.F.	300	215	6,200	246
2.80	1,130	1,500	A.I.-14 R.F.	300	220	6,500	248
3.60	1,440	2,100	A.I.-14 R.F.	300	205	4,100	250
4.16	1,590	2,590	Lycoming O-540-E	2 × 264	270	6,100	252
2.80	1,120	1,900	Lycoming IO-540 G1 D5	290	230	4,500	254
3.30	1,240	1,900	Lycoming IO-540 G1 D5	290	200	3,000	256
2.80	1,180	1,550	Lycoming IO-540 G1 D5	290	230	7,000	258
2.52	900	1,500	Lycoming IO-540 G1 D5	290	—	5,800	260



## II. HELICOPTERS

No.	Type of helicopter	Category	Year	Rotor diameter (m)	Rotor disk area (sq. m)
1	VUIA 1 and 2 F.S.	experimental	1918 1921	2 × 6.50	32.00
2	C.O.-2	experimental	1938	8.00	
3	RG-8 H1 TINTAR	experimental	1960	10.50	
4	I.A.R.-316 B (Alouette-III)	multiple purpose	1971	11.02	

## III. SEAPLANES

No.	Type of seaplane	Category	Year of construction	Dimen (in)	
				span	length
1	ION PAULAT F.S.	—	1911	13.20	11.50
2	R.A.S.-1	Getta training reconnaissance and flying-boat utility	1925	16.00	10.50
3	SAVOIA MARCHETTI S-62 BIS		1936	16.66	12.26
4	I.A.R.-818 H		1964	12.10	9.97

## IV. GLIDERS

No.	Type of glider	Category	Year	Dimen (in)	
				span	length
1	2	3	4	5	6
1	HENRI AUGUST	—	1909	7.00	9.20
2	R.M.-1	basic training	1926	6.00	—
3	G.E.P.	basic training	1939	10.00	5.55
4	R.M.-10	experimental	1943	6.00	—
5	I.C.A.R.-1	basic training	1943	10.78	5.70
6	SALAMANDRA	training	1943	12.50	6.45
7	GRÜNAU BABY-II B	basic and advanced training	1946	13.57	6.09
8	I.S.-2	advanced training	1949	12.30	6.54
9	R.G.-1	basic training	1950	13.50	6.19
10	O.P.-1	aerobatics	1951	11.78	5.60
11	R.G.-2	performance	1952	18.00	8.01
12	R.G.-3	primary training	1953	12.60	6.80
13	I.S.-3	high performance	1953	16.00	6.45
14	R.G.-4 PIONIER	primary training	1954	10.45	5.75
15	I.S.-3a and 3b	performance	1954	16.00	6.66
16	C.T.-2	aerobatic training			
		and high performance	1955	14.60	8.00
17	O.P.-22	experimental	1955	16.00	6.00

Length (m)	Empty weight (kg)	Total weight (kg)	Power plant		maximum speed (km/h)	ceiling (m)	p.
			Type	power (HP)			
	120		Anzani	16			264
7.30	?	410	Pohjoy-Niagara	90	132 (theor.)		266
8.99		660	Walter Minor 4 III	105	136 (rated)		268
12.84	1,122	2,200	Turbomeca Artouste III	570	210	5,900	270

sions m)	Weight (in kg)		Power plant		Performance		p.	
	height	empty	total	type	power (in HP)	maximum speed (km/h)		ceiling (in m)
4.50			520	Hiero	220	35	4,000	£2
3.50	1,245	2,045				160		104
4.19	2,650	4,150	Isotta Fraschini Asso	750	218	4,500	188	
3.84	880	1,220	Walter M 337	170	172	3,500	244	

sions m)	Weight (in kg)		Loading (in kg/sq m)	Lift-drag ratio	Speed		p.
	height	empty			total	minimum sinking (in m/s)	
7	8	9	10	11	12	13	14
—	16.50	—	—	—	—	—	275
—	28.00	68.00	—	—	—	—	276
—	70	140	—	11:00	1.00	—	278
—	60	130	—	—	—	—	280
2.39	115	200	—	—	—	—	282
1.95	110	195	—	15.00	0.83	53.3	284
1.38	165	255	16.9	17.00	0.87	—	286
1.56	160	250	17.00	20.00	0.77	180	288
1.40	156	251	17.60	18.50	0.85	210	290
1.50	240	320	30	25.00	0.85	400	292
2.30	285	465	19.10	23.50	0.70	—	294
1.70	150	310	14.40	16.00	1.00	165	296
1.43	215	305	19.10	30.00	0.65	200	298
1.20	100	188	12.70	14.50	0.90	165	300
1.60	245	335	21.00	28.20	0.75	180	302
—	350	540	—	25.00	0.90	300	304
—	165	255	—	31.00	0.90	170	306

1	2	3	4	5	6
18	I.S.-3c	performance	1956	17.00	7.26
19	I.S.-3d	performance	1956	15.30	7.26
20	G.P.-2	basic and advanced training	1957	16.00	8.00
21	R.G.-5 PESCĂRUȘ	performance	1957	15.10	7.38
22	R.G.-9 ALBATROS	performance	1958	16.45	7.98
23	I.S.-3e	performance	1959	17.00	7.00
24	I.S.-3f	performance	1959	15.30	7.00
25	I.S.-4	performance	1959	15.00	7.10
26	I.S.-7	universal	1959	15.90	8.65
27	I.S.-9 and I.S.-9a	training (also motorised)	1959	13.00	6.64
28	I.S.-11	training and performance	1959	14.10	6.87
29	I.S.-8 and I.S.-8a	basic and advanced training	1960	13.35	7.35
30	I.S.-10	high performance	1960	15.00	7.44
31	I.S.-5	performance	1961	15.30	6.36
32	I.S.-12	basic and advanced training	1962	15.00	7.35
33	I.S.-13	universal	1962	15.00	8.00
34	I.S.-18	training and performance	1965	16.00	7.10
35	I.S.-18/25	training and performance	1969	15.00	6.90
36	I.S.-28	training	1970	15.00	6.76
37	I.S.-29 B	standard training	1970	15.00	7.03
38	I.S.-29 D	training and performance	1970	15.00	7.03
39	I.S.-29 E	high performance			
		unlimited class	1971	17.60	7.03
40	I.S.-28 B	training and performance	1973	17.00	8.17

#### V. GROUND EFFECT - AIR CUSHION - MACHINES

No.	Type of machine	System	Year	Base or cushion area (sqm)	Empty weight (kg)
1	R.-1	periphereal jet	1960	4.00	170
2	R.-5	plenum chamber	1962	5.00	235
3	R.-6	plenum chamber	1963	8.40	225
4	I.S.-26	multiple chamber	1969	42.50	3,000
5	0-1	plenum chamber	1969	4.56	65
6	R.-7	plenum chamber	1970	15.40	1,210
7	0-9	plenum chamber	1970	1.70	45
8	R.-8	plenum chamber	1971	26.83	1,310
9	0-17	plenum chamber	1971	2.89	
10	0-20	plenum chamber	1972	10.00	360
11	R.-10	plenum chamber	1972	52.78	
12	O-23 E		1972	18.00	



7	8	9	10	11	12	13	14
1.60	270	360	22.50	26.90	0.77	180	308
1.60	230	320	20.90	25.30	0.77	180	308
2.20	330	510	—	25.00	0.80	220	310
2.15	210	300	19.50	26.00	0.76	180	312
1.29	290	470	23.50	25.00	0.85	180	314
1.60	270	360	22.50	28.90	0.70	180	316
1.60	230	320	20.90	28.20	0.75	180	316
1.60	230	320	22.90	30.00	0.64	180	318
2.15	330	500	21.00	24.00	0.92	180	320
			(one seater)				
			25.50				
			(two seater)				
2.74	230	320	21.40	21.70	0.88	180	322
		360			0.95	150	
		(with engine)			(with engine)	(with engine)	
1.60	240	330	22.80	26.00	0.84	240	324
1.78	280	430	29.10	22.00	—	180	326
1.60	220	340	25.80	33.00	0.68	180	328
1.60	220	310	20.30	28.00	0.74	180	330
1.78	290	460	20.80	24.00	0.80	200	332
			(one seater)		(one seater)	(one seater)	
			25.60		0.92	180	
			(two seater)		(two seater)	(two seater)	
1.85	290	460	20.80	24.00	0.80	200	334
			(one seater)		(one seater)	(one seater)	
			25.60		0.92	180	
			(two seater)		(two seater)	(two seater)	
1.50	270	370	28.50	35.00	0.63	180	336
1.65	283	375	—	32.50	0.68	220	338
2.18	325	510		26	0.85	200	340
1.68	240	340		36	0.62	220	342
1.68	220	320		37	0.58	220	344
1.68	275	380		42	0.50	220	346
1.87	370	570		32	0.70	240	348

Total weight (kg)	Lift force engine	Propulsion engine	Maximum speed (km/h)	p.
240	IJ-350	cu m, 11 HP		354
305	IJ-350 cu cm, 11 HP	R.D.10, 8 HP		356
300	IJ-350 cu cm, 11 HP	K-125, 5 HP		358
6,000	SR-216, 193 HP	2 × W.M.4-111, 105 HP		361
110	Druzhiba, 4 HP	UZ-2, 1.5 HP		364
1,950	W.M. 4-111, 105 HP	W.M. 4-111, 105 HP		366
100		MOBRA, 4 HP		368
	W.M. 4-111, 105 HP	W.M. 4-111, 105 HP		370
85		DRUZHBA, 4 HP		372
760		W.M. 4-111, 105 HP		374
2,210	M-337, 170 HP	M-337, 170 HP		376
1,400		M-337, 170 HP		378
	(supercharged gives 240 HP at 2,750 rpm)			



### O.-23 E (1972)

Experimental GEM

Length 6.7 m, width 4.04 m, height 2.5 m, lifting area 18 sq m, total weight 1,400 kg.

The *O.-23 E* is an amphibious GEM, designed and built at *ICEPRONAV* (*Shipbuilding Research and Design Institute*) of Galați by a team under Eng. *Matei Kiraly*.

A M-337 engine (170 HP rated at 2,600 r.p.m., when supercharged giving 210 HP at 2,750 r.p.m.) fed through two fuel tanks of 220 litres total capacity, allows a limit of endurance of 4 h 30 mins. The engine is directly geared to an axial fan with six blades, the resulting compressed air being conveyed partly to the lifting air-cushion, and partly to the propulsive jet exhaust.

When in motion, the GEM is steered by four jet-rudders placed in the propulsive exhaust, stability being obtained through a fin located at the GEM's tail.

The *O.-23 E* has undergone both fixed-point and march tests (on dry land and on water) in the Galați area, the crew being composed of pilots *Mircea Leonard* and *Grigore Mircea*, and mechanic *Gheorghe Nedelcu*. The GEM is now prepared for other experiments on the Danube, in winter conditions (on snow, ice and between river ice blocks).

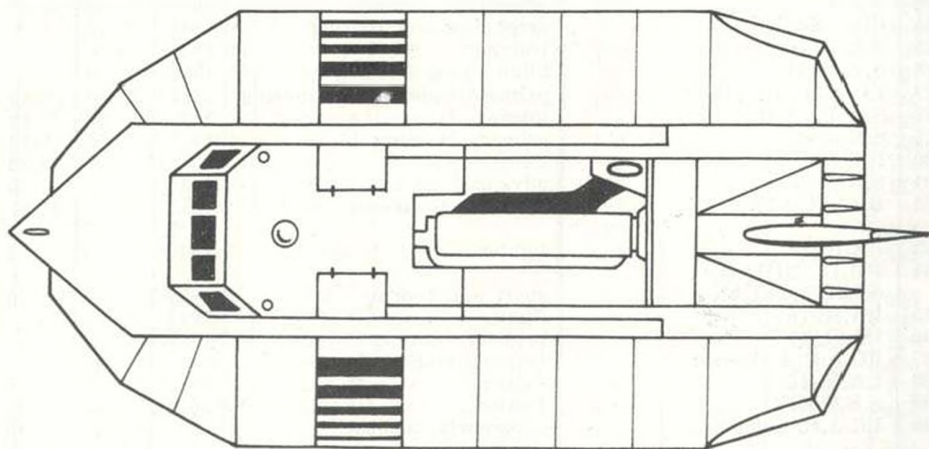
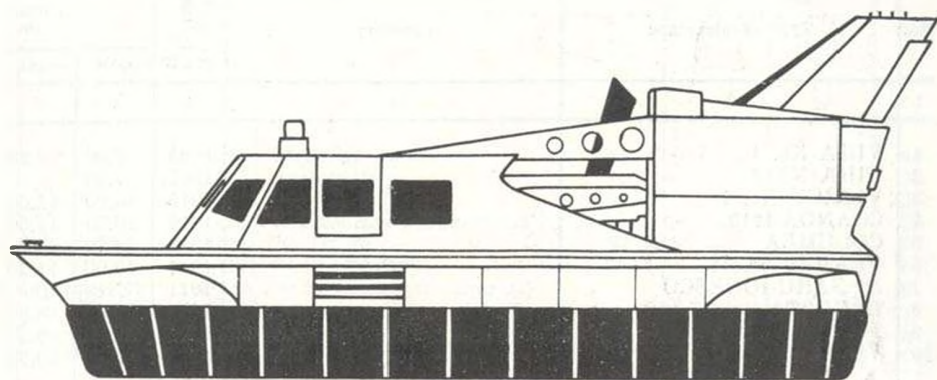





S.E.T. - 31



I.C.A.R. - M 23b



S.E.T. - XV

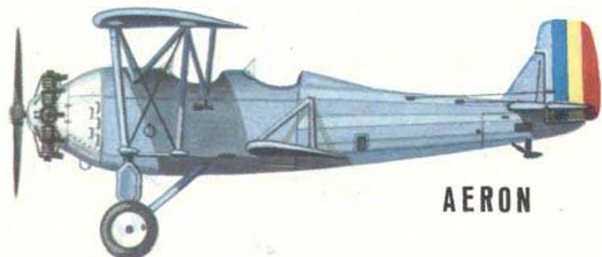

AERON

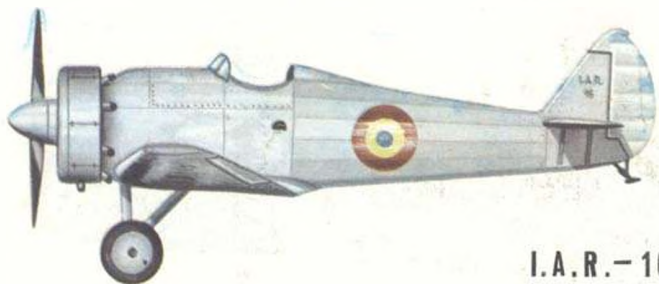

I.A.R.-16



I.C.A.R.  
UNIVERSAL

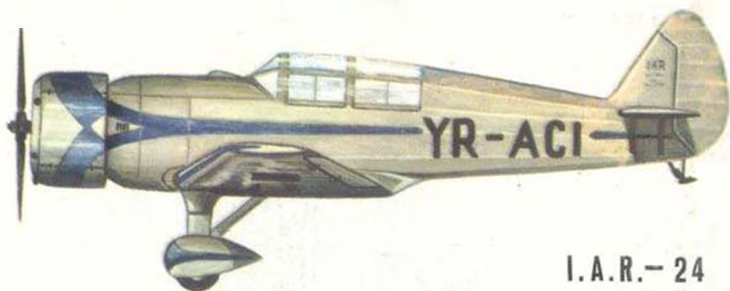

I.A.R.-24



I.C.A.R.  
ACROBATIC



I.A.R. - 39



I.A.R. - 80

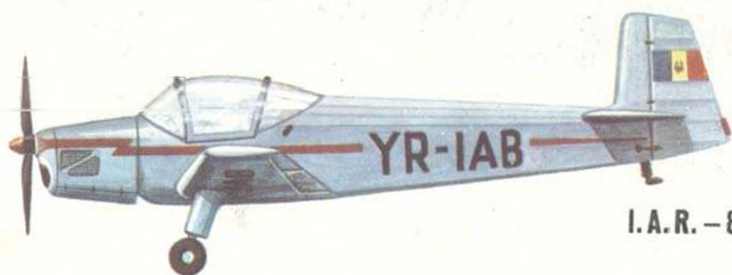

I.A.R. - 813

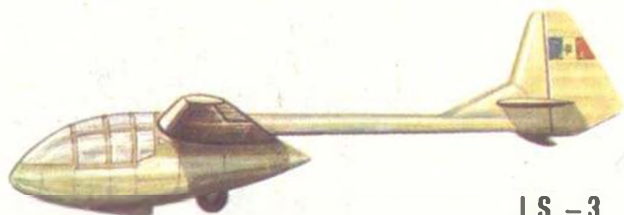

I.S. - 3





R.G.-5 „PESCĂRUȘ”



C.T.-2



M.R.-2



R.G.-6



R.G.-7 „ȘOI M-III”



I.A.R.-817



I.S.-11



I.A.R.-818H

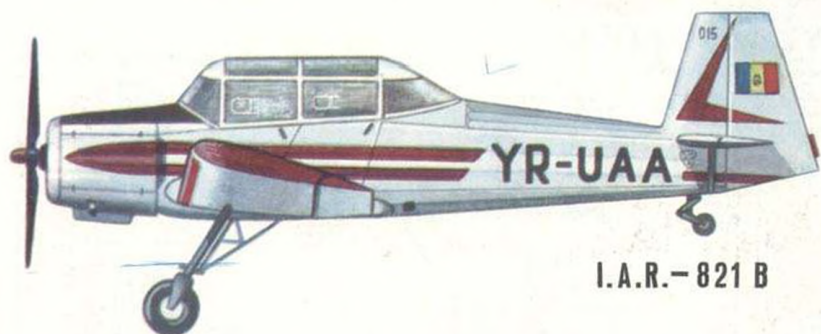

I.A.R.-821 B



I.S.-23

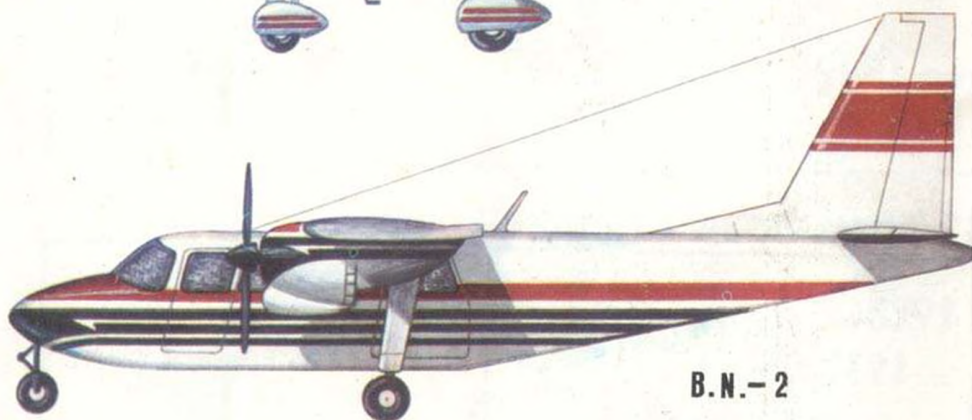

B.N.-2

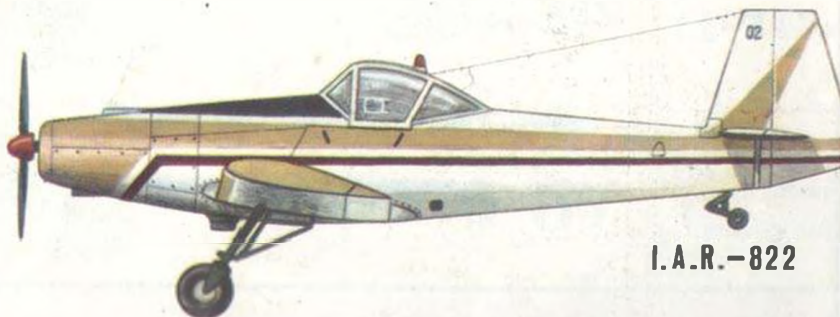

I.A.R.-822